

# General Catalogue



Your Haier Biomedical Partner



Qingdao Haier Biomedical Co., Ltd.

No.280 Feng Yuan Road, High-tech Zone,  
Qingdao, 266109, P.R. China  
E-mail: [inquiry@haierbiomedical.com](mailto:inquiry@haierbiomedical.com)  
Website: [www.haiermedical.com](http://www.haiermedical.com)



Haier Biomedical  
International



Haier Biomedical  
International



@haiermedicalint



Haier Biomedical  
International



Haier Biomedical  
International

Note: If a slight difference occurs between pictures and actual products, please refer to actual products. Our company reserves the right of final interpretation of this brochure, please contact us for any further information if required.



Established in Qingdao, China in 1984, the Haier Group is a world-leading provider of solutions for a better life. With ongoing and sustainable innovation and entrepreneurship, Haier always upholds the principle of "prioritizing people's value". In September 2005, Mr. Zhang Ruimin, Chairman of the Board and CEO of Haier Group, proposed the Rendanheyi Management Model, whose contemporary features, universality and social characteristics have achieved trans-industry and trans-culture fusion and replication. Focusing on user experience and keeping abreast of the times, Haier has experienced six strategic stages: brand building strategy, diversification strategy, internationalization strategy, global branding strategy, networking strategy and ecosystem brand strategy, growing from the once collectively owned small factory on the verge of bankruptcy into an ecosystem that leads the world in the IoT era. As the world's first and only IoT ecosystem brand, Haier has been included on the list of BrandZ Most Valuable Global Brands for three consecutive years and listed in "The World's 500 Most Influential Brands" of the World Brand Lab for 17 years straight. Haier serves over 1 billion families in 160 countries or regions around the world. To date, Haier has successfully floated three listed companies (Haier Smart Home, Haier Biomedical, INKON Life), five large-scale hightech enterprises and 37 medium-sized high-tech companies. Moreover, the Group has established 10+N innovation ecosystems, 28 industrial parks, 122 manufacturing centers, 108 marketing centers and 240,000 sales networks globally.

The Haier Group owns several ecosystem brands and new acquisitions, including Haier, Casarte, Leader, GE Appliances, Fisher & Paykel, AQUA, Candy, COSMOPlat, THREE-WINGED BIRD, Ririshun, Yingkang Life, Haina Cloud, HCH and Haier Brothers as key examples.

Haier has topped Global Major Appliances Brand Rankings by Euromonitor International for 12 consecutive years. The Group's subsidiary Haier Smart Home is among the list of Fortune's Global 500 and World's Most Admired Companies and Forbes' World's 2,000 Largest Public Companies. The COS- MOPlat industrial Internet platform under the Haier Group has topped the cross-sector and cross-field industrial internet platforms of the Ministry of Industry and Information Technology of the People's Republic of China for two years straight. The company was named a leader in Industrial IoT platforms by Forrester and was designated by ISO, IEEE, and IEC, the three major international standard organizations, to lead the drafting of international standards for mass customization models.

Upholding the vision of "creating new growth engine in the era of IoT with the Rendanheyi Model", Haier is committed to working with its world-class ecosystem partners to continuously build and upscale the brand, scenario brand and ecosystem brand, and to set up IoT ecosystems in clothing, food, accommodation, travel, health, elderly care, biomedicine and education, and to tailor personalized smart life for users around the globe.





Haier Biomedical was founded to focus on the design, manufacturing, marketing and sales of low temperature storage equipment for biomedical samples. In 2019, the company successfully listed on the Shanghai Stock Exchange Science and Technology Innovation Board. Expanding more broadly within life science applications, Haier Biomedical utilizes digital technology within its new generation IoT-enabled products to provide comprehensive, customer-centric solutions for common challenges within applications such as blood supply management, vaccine delivery programmes, biobanks, biological sample management, reagent storage and pharmaceutical supply chain.



After more than ten years of development, Haier Biomedical has more than 700 patents. Haier Biomedical's aerospace medical cold storage refrigerators have been carried on the Shenzhou spacecraft into space multiple times, and the ULT freezers have been carried on the research vessel, Xuelong, supporting the Antarctic scientific research programme. Haier Biomedical also assisted in the development of the Chinese Bone Marrow Bank, National Gene Bank and many national strategic support projects.

In 2018 a series of Smart solutions were launched - U-Blood, U-Vaccine, U-Biobank and U-Reagent and U-Lab, these solutions are based on Haier Biomedical's IoT expertise and the core technology advantages in the biomedical cold chain.



The U-Blood solution is based on IoT-enabled blood refrigerators, linking blood collection, blood delivery and clinical blood use settings to ensure in real-time the traceability of blood information from "blood donor" to "blood user". This solution upgrades the users to a model which speeds up blood type matching and blood delivery times, reduces reagent usage, and costs and achieves zero blood wastage, providing better value and better patient outcomes and care.

The U-Vaccine solution is based on the IoT-enabled vaccine refrigerators, providing transparent end-to-end management of vaccines, ensuring vaccine safety and improving vaccination efficiency, security and reliability from manufacturer to inoculation.

Haier Biomedical built the first ecological solution for safe vaccine storage including solar-powered vaccine refrigerators, to effectively ensure the safety of children's vaccination in countries along the Belt and Road and emerging economies, including hard to reach areas due to lack of infrastructure and or access to a sustainable electricity supply. As the first company to be selected into the World Health Organization PQS procurement catalogue, Haier Biomedical has been cooperating with the WHO organization and other internationally recognized NGO's to safeguard the health of 200 million children worldwide.



IoT-enabled ultra-low temperature freezers are used with the U-Biobank software solution which links sample collection, storage and application scenarios to achieve efficient sample management, precise sample positioning, one-click access and fully traceable data for compliance.

The U-Reagent solution solves a common and significant problem of 'loss' within reagent management, enabling zero wastage of pharmaceutical reagents, quick inventory and real-time information, creating efficient and more cost-effective reagent supply chain management.

Haier Biomedical is a corporate and socially responsible organization to its stakeholders and the world at large and through product innovations, solar-powered products and world-leading energy-saving refrigeration technologies it provides environmentally-friendly products to over 150 countries.

Utilizing IoT solutions within manufacturing, Haier Biomedical can monitor and control, in real-time, complex automated processes. This delivers significant benefits in terms of energy conservation, facility and resource management, production flow monitoring and inventory management to quality control, packaging, logistics and supply chain optimization. It ensures its manufacturing operations, technological developments and supply chain and customers collectively support sustainable business practices.

### Haier Biomedical Development Stages:

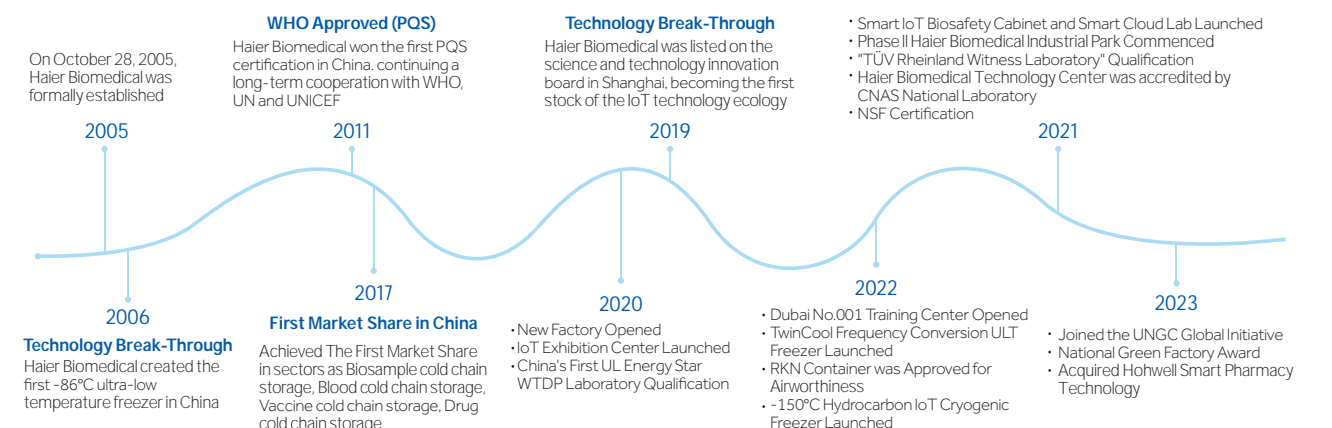

# CONTENT

## Preservation

**-150°C Cryo Freezer** 07

**-86°C ULT Freezer** 11

TwinCool Frequency Conversion ULT Freezer  
TwinCool ULT Freezer  
Frequency Conversion ULT Freezer  
Water-Cooled ULT Freezer  
Standard Low Energy ULT Freezer with LCD Touchscreen  
Standard Low Energy ULT Freezer with LED Display  
Under Counter ULT freezer  
Mini ULT Freezer  
CO<sub>2</sub> Backup System  
Controlled Rate Freezer  
Freeze Dryer  
Lab Consumables Storage Solutions

**Biomedical Freezer** 77

-60°C Biomedical Freezer  
-40°C Biomedical Freezer  
-30°C Biomedical Freezer  
-25°C Biomedical Freezer

**Spark Free Refrigerator/Freezer** 125

Spark Free Refrigerator  
-30°C Spark Free Freezer

**Laboratory Refrigerator** 141

**Transportation** 141

Active Temperature Controlled RKN Container  
Transport Cooler for Biological Products  
Transport Cooler for Infectious Products  
Vaccine Transport Cooler  
Portable Transport Cooler  
Car Refrigerator-W Series  
Cold Chain Transport Cooler  
Insulated Container  
Intelligent Control Cold Chain Transport Cooler  
Logistics Cold Chain Transport Cooler  
Mini ULT Freezer  
Liquid Nitrogen Storage System  
Energy Storage Power Supply

## Pharmacy Refrigerator

**New Generation Pharmacy Refrigerator** 171

**RFID Refrigerator** 181

**Advanced Pharmacy Refrigerator with LCD Touchscreen** 183

**Advanced Pharmacy Refrigerator with LED Display** 184

**Standard Pharmacy Refrigerator** 185

**Under-counter Pharmacy Refrigerator** 191

**Pharmacy Refrigerator** 199

**Combined Refrigerator and Freezer** 203

## Blood Bank Solutions

**Automated Blood Management Refrigerator** 203

**Unattended Self-Service Blood Distribution Refrigerator** 216

**Advanced Blood Bank Refrigerator with LCD Touchscreen** 221

**Advanced Blood Bank Refrigerator with LED Display** 222

**4°C Blood Bank Refrigerator** 225

**Blood Bank Refrigerators** 225

**Plasma Freezer** 231

**Plasma Apheresis System** 233

**Plasma Blast Freezer** 235

**Platelet Incubator with Agitator** 241

## Vaccine Storage

**Smart Vaccine Refrigerator** 245

**Solar Direct Drive Series** 245

Solar Direct Drive Combined Refrigerator/Freezer  
Solar Direct Drive Vaccine Refrigerator  
Solar Direct Drive Vaccine Freezer  
Solar Direct Drive Blood Refrigerator

**Ice-Lined Refrigerator** 261

**Vaccine & Icepack Freezer** 267

**Walk-in Cold/Freezer Room** 269

**Remote Temperature Monitoring Device** 274

**30-Day Electronic Temperature Logger** 283

## Clean Air Solution

**NSF Series Biological Safety Cabinet** 281

**Smart IoT Series Biological Safety Cabinet** 284

**Biological Safety Cabinet** 289

**Mini Biological Safety Cabinet** 299

**Classic Series Biological Safety Cabinet (Type A2)** 301

**Classic Series Biological Safety Cabinet (Type B2)** 304

**Animal Containment Workstation** 305

**Laminar Flow Cabinet** 308

**Ductless Fume Hood** 311

## Incubators

**CO<sub>2</sub> Incubator** 317

**Standard Incubator** 325

**Climate Chamber** 332

**Cooled Incubator** 339

**Cell Culture Scene Consumables Management** 342

**Pipette Series** 346

**Centrifuge Tube Series** 348

## Sterilization

**Drying Oven** 351

**Vertical Autoclave** 357

**Horizontal Bench-top Autoclaves** 361

**Hydrogen Peroxide Disinfectant** 363

## Centrifuges

**Floor-Standing Low-Speed Refrigerated Centrifuge** 369

**Benchtop High-Speed Centrifuge** 381

**Benchtop Low-speed Centrifuge** 383

**Mini-Centrifuge** 385

**Centrifuge Consumables** 388

**Centrifuge Consumables-PCR** 393

## LN<sub>2</sub> Storage

**Biobank Series for Large Scale Storage** 397

**CryoBio Biobank Series Liquid Nitrogen Container** 407

**CryoStation Mobile Vapour Storage Trolley** 411

**Bio-2T Cryovial Transfer Flask** 413

**BioT Air Cryovial Transfer Flask** 415

**Intelligent Liquid Nitrogen Biological Container** 417

**CryoBio 6S Liquid Nitrogen Container with Autorefill** 419

**Smart Series (Square Racks)** 421

**Medium Sized Storage Series (Square Racks)** 424

**Small Sized Storage Series (Square Racks)** 434

**High Capacity Series for Storage or Transport (Round Canisters)** 436

**Dryshipper Series for Transportation (Round Canisters)** 445

**Self-pressurized Series for LN<sub>2</sub> Storage and Supply** 446

## Product Portfolio

**Product Portfolio** 450



**Haier Biomedical**  
Intelligent Protection of Life Science



**-150°C  
Cryo Freezer**



A mechanical cryogenic freezer is used for the long-term cryopreservation of samples such as cell cultures, tissue samples, bacteria, viruses and non-biological products such as electronics. Applications include cord blood preservation, biobanks, reproductive procedures, blood banks, life science research, biomedical engineering and fisheries. Mechanical cryopreservation is a safe alternative to LN2 and can reduce or eliminate the reliance on LN2, reducing safety concerns.

Specifications

Model		DW-150W209	DW-150W209A	
Technical Data	Cabinet Type	Chest	Chest	
	Climate Class	N	N	
	Cooling Type	Direct cooling	Direct cooling	
	Defrost Mode	Manual	Manual	
	Refrigerant	HC	HC	
Performance	Sound Level (dB(A))	55	55	
	Cooling Performance (°C)	-150	-150	
Control	Temperature Range (°C)	-140--150	-140--150	
	Controller	Microprocessor	Microprocessor	
Electrical Data	Display	LCD	LCD	
	Power Supply (V/Hz)	220-240/50	208-230/60	
Dimensions	Electrical Current (A)	10	12	
	Capacity (L/Cu.Ft)	209/7.4	209/7.4	
	Net/Gross Weight	kg	260/295	260/295
		lbs	573.2/650.4	573.2/650.4
	Interior Dimension (W*D*H)	mm	667*462*677	667*462*677
		in	26.3*18.2*26.7	26.3*18.2*26.7
	Exterior Dimension (W*D*H)	mm	1650*860*1010	1650*860*1010
		in	65.0*33.9*39.8	65.0*33.9*39.8
	Packing Dimension (W*D*H)	mm	1810*960*1170	1810*960*1170
		in	71.3*37.8*46.1	71.3*37.8*46.1
Container load (20'/40'/40'H)		12/24/24	12/24/24	
Functions	High/Low Temperature	Y	Y	
	Hot Condenser	Y	Y	
	Power Failure	Y	Y	
	High/Low Voltage	Y	Y	
	Sensor Error	Y	Y	
	Low Battery	Y	Y	
	High Ambient Temperature	Y	Y	
	Door Ajar	Y	Y	
	Start-up Delay	Y	Y	
	Caster	Y	Y	
	Foot	Y	Y	
	Porthole	Y/1	Y/1	
Accessories	Shelves/Inner Doors	-/2	-/2	
	USB Interface	Y	Y	
	Remote Alarm	Y	Y	
	5V Power Supply Port	Y	Y	
	Temperature Chart Recorder	Optional	Optional	
	RS232/485 Port	NA/Standard	NA/Standard	
	CO <sub>2</sub> Backup System	N/A	N/A	
	LN <sub>2</sub> Backup System (Built-in/External)	Optional/Optional	Optional/Optional	
	Freezing Rack	433026, Quantity: 12 433028, Quantity: 12	433026, Quantity: 12 433028, Quantity: 12	
	Other	Certification	CE	UL

**Energy Efficient Hydrocarbon Refrigeration**

- Includes specialist industrial compressor, hydrocarbon refrigerant, dual-compressors 4-stage cascade refrigeration system, which delivers excellent energy-efficiencies
- Energy-efficient fan design with intelligent start/stop

**Environmentally Friendly**

- 100% HC refrigerant truly environmental-friendly refrigeration system with zero global warming potential (GWP)
- LBA polyurethane foam has low GWP and is significantly lower than most HFCs commonly used, offering better environmental protection

**Superior Uniformity**

The temperature **uniformity** is ±5°C with the setting temperature of -150°C

**Low Noise**

Noise-reduction features and noise reduction design lowers to noise to 55 dB (A)

**Safe, Secure and Reliable**

Multiple alarms, including high and low temperature, power failure, door ajar, hot condenser, low battery, sensor error, and high ambient temperature. The standard ambient temperature ranges from 10°C to 32°C. The pressure state of the system can be automatically adjusted by the pressure controller to prevent the pressure from being too high to effect the freezer operation.



Product appearance and specifications are subject to change without notice





**TwinCool  
Frequency  
Conversion  
ULT Freezer**

**TwinCool**

**Salvum  
Ultimate**

**TwinCool**

**Haier**

## Product Advantages

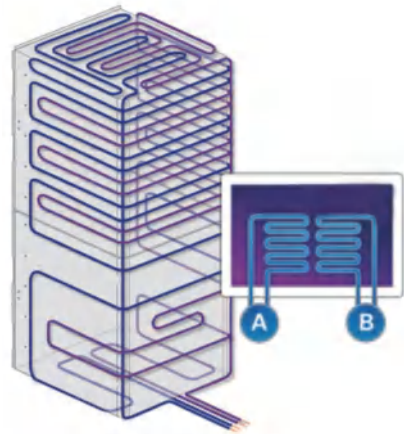

**Dual refrigeration system for optimal reliability and security**  
Two independent hydrocarbon (HC) refrigeration systems, each can maintain -80°C ensuring the safety of stored samples

**World-leading Energy Saving Refrigeration Technology**  
Intelligent frequency conversion technology and HC refrigeration system delivers a 50% reduction in energy usage when compared to traditional HFC refrigeration systems

**Environmental Protection**  
Environmentally friendly hydrocarbon refrigerant and LBA foam material

**Optional IoT System**  
The optional IoT monitors the operating status of the equipment in real time. Equipped with multiple alarm functions and a self-diagnostics system to identify and warn users to ensure sample safety

## Ergonomic Design

**Low Noise Design**  
Optimised systems and noise-reducing cabinet design lower noise out to 42dB for a quieter working experience

**Adjustable Sample Loading Tray (Optional)**  
The adjustable height sample load tray provides users with a convenient place to hold samples while opening and accessing storage compartments

**Large loading capacity**  
Maximum Capacity: 600 boxes (2 inch boxes with 10\*10 configuration) 60,000 samples can be stored

**Intelligent Control**  
10.1-inch high-performance touch screen, sensitive touch operation. Using the optional IoT module, users can check the real-time operating status from an App

**Ergonomic design**  
Document holder for easy storage of documents



**High quality door opening experience**  
The ergonomic chamfer design of the handle ensures smooth operation and maximum durability



**Adjustable feet**  
For easy positioning and levelling



**Magnetic filter screen**  
Filter screen is easy to clean



DW-86L828BPST

**Microcomputer control**  
Microcontroller with 10.1 inch LCD touch screen displays temperature and other important data. Temperature display precision is 0.1°C

**Multiple alarms**  
Including high/low temperature alarm, sensor error alarm, hot condensor alarm, power failure alarm, low battery alarm, door ajar alarm, high ambient temperature alarm, etc



**Multiple safety lock**  
Standard mechanical lock, optional electromagnetic lock. Optional fingerprint lock and NFC for optimal security and access



**Networking function**  
Equipped with RS485 interface to connect multiple freezers



## Temperature Curve

Temperature Cool Down Curve

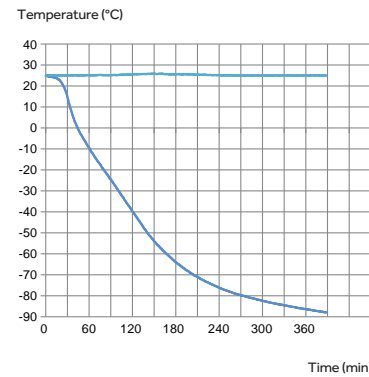

Stability Curve

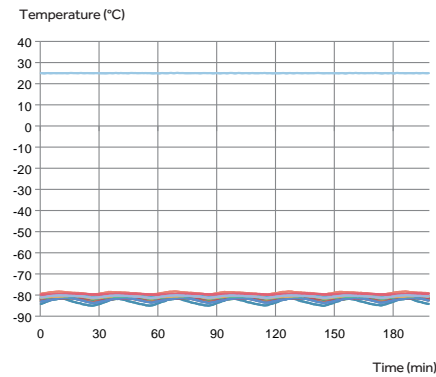

Temperature Recovery Curve

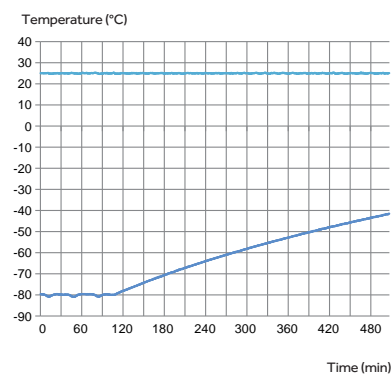

— 3<sup>rd</sup> centre  
 — amb temp  
 — ave temp  
 — 1<sup>st</sup> center temp  
 — 2<sup>nd</sup> left outer temp  
 — 2<sup>nd</sup> right inner temp  
 — 3<sup>rd</sup> center temp  
 — 1<sup>st</sup> left inner temp  
 — 1<sup>st</sup> right outer temp  
 — 2<sup>nd</sup> center temp  
 — 3<sup>rd</sup> left inner temp  
 — 3<sup>rd</sup> right outer temp

## Product Dimensions

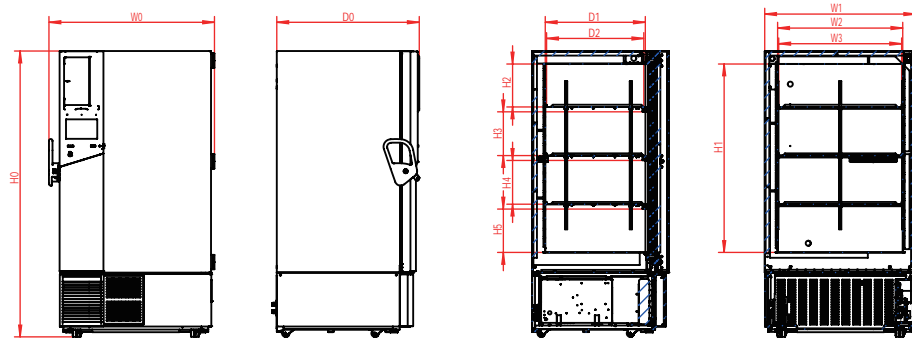

W0	W1	W2	W3	H0	H1	H2	H3	H4	H5	D0	D1	D2
1145mm	1050mm	870mm	854mm	1980mm	1310mm	298mm	303mm	303mm	301mm	998mm	695mm	676mm

## Specifications

Model	DW-86L578BPST	DW-86L728BPST	DW-86L828BPST
<b>Technical Data</b>			
Cabinet Type	Upright	Upright	Upright
Climate Class	N	N	N
Cooling Type	Direct cooling	Direct cooling	Direct cooling
Defrost Mode	Manual	Manual	Manual
Refrigerant	HC	HC	HC
Sound Level (dB(A))	42	42	42
<b>Performance</b>			
Cooling Performance (°C)	-86	-86	-86
Temperature Range (°C)	-40--86	-40--86	-40--86
<b>Control</b>			
Controller	Microprocessor	Microprocessor	Microprocessor
Display	LCD	LCD	LCD
<b>Electrical Data</b>			
Power Supply (V/Hz)	100-230/50/60Hz	100-230/50/60Hz	100-230/50/60Hz
Electrical Current (A)	10.4	10.4	13
<b>Dimensions</b>			
Capacity (L/Cu.Ft)	578/20.4	728/25.7	828/29.2
Net/Gross Weight (approx)	kg	325/355	350/385
	lbs	716.5/782.6	771.6/848.8
Interior Dimension (W*D*H)	mm	620*716*1310	766*716*1310
	in	24.4*28.2*51.6	30.2*28.2*51.6
Exterior Dimension (W*D*H)	mm	895*998*1980	1046*998*1980
	in	35.2*39.3*78.0	41.2*39.3*78.0
Packing Dimension (W*D*H)	mm	975*1095*2130	1120*1090*2130
	in	38.4*43.1*83.9	44.1*42.9*83.9
Cabinet Width (without handle and hinge)	mm	800	946
Container Load (20'/40'/40'H)		12/24/24	10/22/22
<b>Functions</b>			
High/Low Temperature	Y	Y	Y
Hot Condenser	Y	Y	Y
Power Failure	Y	Y	Y
High/Low Voltage	Y	Y	Y
Sensor Error	Y	Y	Y
Low Battery	Y	Y	Y
High Ambient Temperature	Y	Y	Y
Door Ajar	Y	Y	Y
Start-up Delay	Y	Y	Y
<b>Accessories</b>			
Caster	Y	Y	Y
Foot	Y	Y	Y
Porthole	Y/2	Y/2	Y/2
Shelves/ Inner Doors	3/4	3/4	3/4
USB Interface	Y	Y	Y
Remote Alarm	Y	Y	Y
5V Power Supply Port	Y	Y	Y
Temperature Chart Recorder	Optional	Optional	Optional
RS232/485 Port	NA/Standard	NA/Standard	NA/Standard
CO <sub>2</sub> Backup System	Optional	Optional	Optional
LN <sub>2</sub> Backup System	Optional	Optional	Optional
<b>Certifications</b>			
CE	Y	Y	Y
UL	Y	Y	Y



TwinCool  
ULT Freezer



## Scope of Application

The TwinCool ULT freezer can be used for the storage and protection of valuable samples which require strict and continuous storage conditions, designed to operate even in the event of a compressor failure. Suitable for viruses, pathogens, blood cells and other biological sample cold storage applications found within hospitals, disease control, research institutions and biomedical engineering. Also used to store special materials and other products within electronics and chemicals industries.

## Advanced Hardware System



### Smart Full-size Touch Screen

10-inch touch screen with state-of-art user interface design, coupled with sample management system provides optimal user experience.

## Optional IOT & Sample Management System (Professional Edition)



### Simplified Sample Management Experience

Barcode scanner for simple, effortless and precise identification. Input and retrieve your samples with higher precision and efficiency



### Wireless Monitoring Connectivity

Check the real-time operating status via mobile phones or palmtop, simple and reliable

## Friendly Design



### Safe and secure

Equipped with key lock, padlock and optional electromagnetic lock, with optional fingerprint lock, providing multiple safeguards for sample safety



### Cloud data storage available

Store hundreds of millions of scientific research and sample information in the cloud server

### A Dual independent refrigeration systems for maximum sample safety

The dual refrigeration systems run independently and alternately, both reaching -80°C, such that if one system fails the other will maintain temperature to ensure sample storage safety.

### B High speed refrigeration system for faster pull down and temperature recovery after door opening

Utilizing auto-cascade hydrocarbon (HC) refrigeration technology to deliver fast temperature pull down. From an ambient of 25°C it takes just 180 minutes to reach -80°C. It provides a quick temperature recovery after door opening, with the internal temperatures returning to -75°C within 1 minute, guaranteeing safety of samples.

### C World-leading energy saving refrigeration technology

The HC refrigeration technology coupled with superinsulation, which increases the insulation efficiency by 30%, and a cabinet designed to reduce heat loss ensures an energy efficient freezer. The 578L model has a power consumption of 11 kWh/day and is certified by The National Quality Certification Center for Energy Saving and Environmental Protection.



### Low noise design, reducing the noise down to 53dB

Special noise-reduction design plus super silent compressor technology and energy-saving fan, considerably lowers noise level



### Optimized insulation

Double foaming for both inner and outer doors and five-layer sealing design and optimized super-thick VIP thermal insulation technology, extends temperature holdover time during power failure and increases insulation efficiency by 30%

## Specifications

Model	DW-86L578ST	DW-86L578SAT	DW-86L728ST	DW-86L728SAT		
Technical Data	Cabinet Type	Upright	Upright	Upright	Upright	
	Climate Class	N	N	N	N	
	Cooling Type	Direct cooling	Direct cooling	Direct cooling	Direct cooling	
	Defrost Mode	Manual	Manual	Manual	Manual	
	Refrigerant	HC	HC	HC	HC	
	Sound Level (dB(A))	53   52	53	50   53	53	
Performance	Cooling Performance (°C)	-86	-86	-86	-86	
	Temperature Range (°C)	-40--86	-40--86	-40--86	-40--86	
Control	Controller	Microprocessor	Microprocessor	Microprocessor	Microprocessor	
	Display	LCD Touchscreen	LCD Touchscreen	LCD Touchscreen	LCD Touchscreen	
Electrical Data	Power Supply (V/Hz)	220-240/50   120/60	208~230/60	208-230/50   120/60	208~230/60	
	Electrical Current (A)	10   18	10	10   18	10	
Construction	Capacity (L/Cu.Ft)	578/20.4	578/20.4	728/25.7	728/25.7	
	Net/Gross Weight (approx)	kg	325/355	325/355	350/385	350/385
		lbs	716.5/782.6	716.5/782.6	771.6/848.8	771.6/848.8
	Interior Dimension (W*D*H)	mm	620*716*1310	620*716*1310	766*716*1310	766*716*1310
		in	24.4*28.2*51.6	24.4*28.2*51.6	30.2*28.2*51.6	30.2*28.2*51.6
	Exterior Dimension (W*D*H)	mm	895*998*1980	895*998*1980	1046*998*1980	1046*998*1980
in		35.4*39.3*78.0	35.4*39.3*78.0	41.2*39.3*78.0	41.2*39.3*78.0	
Packing Dimension (W*D*H)	mm	975*1095*2130	975*1095*2130	1120*1090*2130	1120*1090*2130	
	in	38.4*43.1*83.9	38.4*43.1*83.9	44.1*42.9*83.9	44.1*42.9*83.9	
Loading Quantities	Container Load (20'/40'/40'H)	12/24/24	12/24/24	10/22/22	10/22/22	
	High/Low Temperature	Y	Y	Y	Y	
Alarms	Hot Condenser	Y	Y	Y	Y	
	Power Failure	Y	Y	Y	Y	
	High/Low Voltage	Y	Y	Y	Y	
	Sensor Error	Y	Y	Y	Y	
	Low Battery	Y	Y	Y	Y	
	High Ambient Temperature	Y	Y	Y	Y	
	Door Ajar	Y	Y	Y	Y	
	Caster	Y	Y	Y	Y	
Accessories	Foot	Y	Y	Y	Y	
	Porthole	Y/2	Y/2	Y/2	Y/2	
	Shelves/Inner Doors	3/4	3/4	3/4	3/4	
	USB Interface	Y	Y	Y	Y	
	Remote Alarm (Dry contacts)	Y	Y	Y	Y	
	5V Power Supply Port	Y	Y	Y	Y	
	Temperature Recorder	Optional	Optional	Optional	Optional	
	RS485 Port	Y	Y	Y	Y	
	CO <sub>2</sub> Backup System	Optional	Optional	Optional	Optional	
	LN <sub>2</sub> Backup System	Optional	Optional	Optional	Optional	
Certifications	CE	Y   /	/	Y   /	/	
	UL	/   Y	Y	/   Y	Y	
	ENERGY STAR	Y   Y	Y	Y   Y	Y	

Product appearance and specifications are subject to change without notice

The TwinCool ultra-low temperature freezer of Haier Biomedical provides the highest level of protection for your valuable samples.



DW-86L578S

## Safer by Design

Haier Biomedical's ultra low temperature freezers with intelligent TwinCool technology are designed to provide optimal cabinet reliability, longevity, efficiency and sample protection. This super efficient technology also improves the energy efficiency of our third generation ULT freezers and leads the way in terms of product innovation.

### Intelligent TwinCool Refrigeration System

Two independent refrigeration systems are designed to ensure optimal reliability, longevity and efficiency. Depending on the load demands and ambient conditions, one or both refrigeration systems will operate on demand, ensuring the samples are fully protected under the worst possible condition.



#### Maximum Sample Security

TwinCool system means extra insurance for temperature. Each independent refrigeration system can maintain -80°C separately.

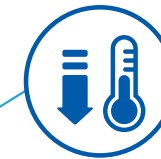

#### Fast Cabinet Pull Down

Fast and efficient cabinet pulldown, it usually takes an average of three hours to reach -80°C at 25°C ambient. This means the temperature recovery after door opening is excellent ensuring the stored samples are not exposed to undesirable temperatures.

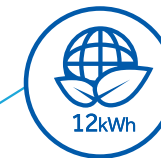

#### Maximum Energy Efficiency

The TwinCool ultra-low temperature system operates with 12 kWh/day.



#### World-leading Energy Saving Refrigeration Technology

The Haier hydrocarbon refrigeration technology uses less than 50% energy compared to traditional CFC refrigerants to reduce the operating cost. The refrigerants do not contain fluorine or chlorine giving it a GWP value of just three, which is better for the environment.



#### Reduced Running Costs

VIP thermal insulation system is designed to significantly reduce heat gain and operating cost.





**Energy Saving Refrigeration**  
High efficiency cooling fans and compressors, combined with hydrocarbon refrigerants, ensure energy savings and long-term sample security



**Multilayered Sealing Structure**  
Multilayered gaskets decrease heat loss and guarantee excellent warm up times in the event of a power failure



**Pressure Equalisation Port**  
Heated Pressure Equalization Port allows users to re-open the main door quickly when entering. Adopts chromium plating, rust-proof



**Improved Handle Design**  
Lockable handle safeguards your precious samples. A padlock can also be added for extra sample safety



**USB Interface**  
Enables users to download historical temperature data for compliance/auditing purposes



**Multi-level Alarms**  
Alarm functions include high, low temperature, sensor error, power failure, high ambient, clean filter and door ajar



DW-86L578S

DW-86L578S | TYPICAL PERFORMANCE CHARACTERISTICS AT 25°C AMBIENT

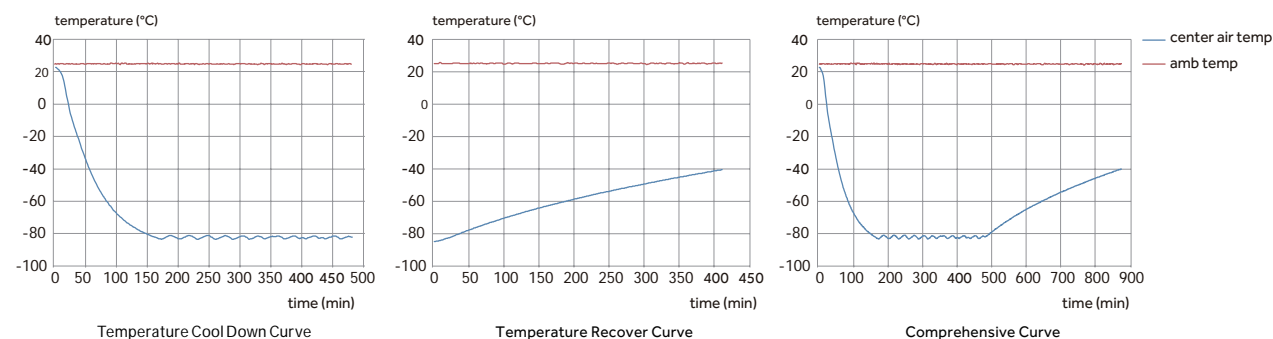

Specifications

	Model	DW-86L578S	DW-86L728S	
Technical Data	Cabinet Type	Upright	Upright	
	Climate Class	N	N	
	Cooling Type	Direct Cooling	Direct Cooling	
	Defrost Mode	Manual	Manual	
	Refrigerant	HC	HC	
	Sound Level (dB(A))	53	50	
Performance	Cooling Performance (°C)	-86	-86	
	Temperature Range (°C)	-40~-86	-40~-86	
Control	Controller	Microprocessor	Microprocessor	
	Display	LED	LED	
Electrical Data	Power Supply (V/Hz)	220~240/50	220~240/50	
	Electrical Current (A)	10	10	
Construction	Capacity (L/Cu.Ft)	578/20.4	728/25.7	
	Net/Gross Weight (approx)	kg	325/355	350/385
		lbs	716.5/782.6	771.6/848.8
	Interior Dimension (W*D*H)	mm	620*716*1310	766*716*1310
		in	24.4*28.2*51.6	30.2*28.2*51.6
	Exterior Dimension (W*D*H)	mm	895*998*1980	1046*998*1980
		in	35.4*39.3*78.0	41.2*39.3*78.0
	Packing Dimension (W*D*H)	mm	975*1095*2130	1120*1090*2130
		in	38.4*43.1*83.9	44.1*42.9*83.9
	Loading Quantities	Container load (20'/40'/40'H)	12/24/24	10/22/22
Alarms	High/Low Temperature	Y	Y	
	Hot Condenser	Y	Y	
	Power Failure	Y	Y	
	Sensor Error	Y	Y	
	Low Battery	Y	Y	
	High Ambient Temperature	Y	Y	
	Door Ajar	Y	Y	
Accessories	Caster	Y	Y	
	Foot	Y	Y	
	Porthole	Y/2	Y/2	
	Shelves/Inner doors	3/4	3/4	
	USB Interface	Y	Y	
	Remote Alarm (Dry contacts)	Y	Y	
	5V Power Supply Port	Y	Y	
	Temperature Recorder	Optional	Optional	
	RS485	Y	Y	
	CO <sub>2</sub> Backup System	Optional	Optional	
	LN <sub>2</sub> Backup System	Optional	Optional	
Certifications	CE	Y	Y	
	ENERGY STAR	Y	Y	

S suffix - Dual independent refrigeration systems  
Product appearance and specifications are subject to change without notice





Frequency  
Conversion ULT  
Freezer



## Scope of Application

Applicable for products and samples which require strict storage conditions such as viruses, pathogens, red blood cells, white blood cells, skin, bones, bacteria, semen, biological products, electronics and special materials. Suitable for long term storage applications and compliant with typical storage requirements found in hospitals, disease control and prevention centers, scientific research institutions, biomedical engineering institutes, agriculture/ fishery companies as well as the electronics and chemical industry.

## Advanced Hardware System



### Smart Full-size Touch Screen

10-inch capacitive touch screen, state-of-art UI design coupled with sample management system to provide the optimal user experience.



### HC & Variable Frequency Drive Refrigeration System for Additional Energy Saving

Advanced innovative design delivers excellent energy savings. The energy consumption is down to a single digit.

## Optional IoT Software System



### Simplified Sample Management Experience

Optional barcode scanner for simple, effortless and precise identification. Input and retrieve your samples with higher precision and efficiency



### Wireless Monitoring Connectivity

Check the real-time operating status via mobile phones or palmtop, simple and reliable

### A Quicker product access, identification and retrieval

Instead of a manual system, the one-gun, one-code and one-key operation plus touch screen synchronization means you can access and retrieve your samples within seconds

### B 24-hour sample protection

Using Haier's app and IoT technology the unit can be monitored and can self-diagnose faults, ensuring you are always aware of your unit's status and able to make real-time and informed choices to protect your samples

### C Cloud data storage available

Store hundreds of millions of scientific research and sample information in the cloud server

## Friendly Design



### Safe and secure

Standard equipped with key lock, padlock and electromagnetic lock with optional fingerprint lock, providing multiple safeguards for sample safety



### Low noise design, reducing the noise down to 43.5dB

Special noise-reduction design plus super silent compressor technology and energy-saving fan, considerably lowers noise level



### Super energy efficient with three environmentally friendly innovations

Ultra-low power consumption, down to less than 10kWh/day, ensuring a world leading energy saving performance



### Optimized insulation

Double foaming for both inner and outer doors and five-layer sealing design and optimized super-thick VIP thermal insulation technology, extends temperature holdover time during power failure and increases insulation efficiency by 20%

## Specifications

Model	DW-86L579BPT	DW-86L729BPT	DW-86L829BPT	DW-86L959BPT		
Technical Data	Cabinet Type	Upright	Upright	Upright	Upright	
	Climate Class	N	N	N	N	
	Cooling Type	Direct Cooling	Direct Cooling	Direct Cooling	Direct Cooling	
	Defrost Mode	Manual	Manual	Manual	Manual	
	Refrigerant	HC	HC	HC	HC	
	Sound Level (dB(A))	43.5	43.5	43.5	47	
Performance	Cooling Performance (°C)	-86	-86	-86	-86	
	Temperature Range (°C)	-40~-86	-40~-86	-40~-86	-40~-86	
Control	Controller	Microprocessor	Microprocessor	Microprocessor	Microprocessor	
	Display	Touch Screen LCD	Touch Screen LCD	Touch Screen LCD	Touch Screen LCD	
Electrical Data	Power Supply (V/Hz)	100-230/50/60	100-230/50/60	100-230/50/60 208-230/50/60	100-230/50/60 208-230/50/60	
	Electrical Current (A)	14	14	15 6	20 7	
Dimensions	Capacity (L/Cu.Ft)	579/20.4	729/25.7	829/29.2	959/33.9	
	Net/Gross Weight (approx)	kg	325/355	350/385	380/415	450/485
		lbs	716.5/782.6	771.6/848.8	837.7/914.9	992.1/1069.2
	Interior Dimension (W*D*H)	mm	620*716*1310	766*716*1310	870*716*1310	1016*716*1310
		in	24.4*28.2*51.6	30.2*28.2*51.6	34.3*28.2*51.6	40.0*28.2*51.6
	Exterior Dimension (W*D*H)	mm	895*998*1980	1046*998*1980	1145*998*1980	1296*998*1980
		in	35.2*39.3*78.0	41.2*39.3*78.0	45.1*39.3*78.0	51.0*39.3*78.0
	Packing Dimension (W*D*H)	mm	975*1095*2130	1120*1090*2130	1240*1080*2130	1410*1160*2185
		in	38.4*43.1*83.9	44.1*42.9*83.9	48.8*42.5*83.9	55.5*45.7*86.0
	Container load (20'/40'/40'H)		12/24/24	10/22/22	5/11/11	5/10/10
Functions	High/Low Temperature	Y	Y	Y	Y	
	Hot Condenser	Y	Y	Y	Y	
	Power Failure	Y	Y	Y	Y	
	High/Low Voltage	Y	Y	Y	Y	
	Sensor Error	Y	Y	Y	Y	
	Low Battery	Y	Y	Y	Y	
	High Ambient Temperature	Y	Y	Y	Y	
	Door Ajar	Y	Y	Y	Y	
	Start-up Delay	Y	Y	Y	Y	
	Accessories	Caster	Y	Y	Y	Y
Foot		Y	Y	Y	Y	
Porthole		Y/2	Y/2	Y/2	Y/2	
Shelves/Inner Doors		3/4	3/4	3/4	3/4	
USB Interface		Y	Y	Y	Y	
Remote Alarm		Y	Y	Y	Y	
5V Power Supply Port		Y	Y	Y	Y	
Temperature Chart Recorder		Optional	Optional	Optional	Optional	
RS485 Port		Y	Y	Y	Y	
CO <sub>2</sub> Backup System		Optional	Optional	Optional	Optional	
LN <sub>2</sub> Backup System	Optional	Optional	Optional	Optional		
Certifications	CE	Y	Y	/ Y	/ Y	
	UL	Y	Y	Y /	Y /	
	ENERGY STAR	Y	Y	Y Y	Y Y	

Haier Biomedical reserves the right to change products and specifications without prior notice.

Haier Biomedical's SmartFrequency technology manages the compressor speeds on demand. The ultra-low temperature freezers can thus achieve the world-leading energy efficiency in ultra-low temperature.

### Smarter by Design

The SmartFrequency Conversion range of ultra low temperature freezers have been designed and developed at the Haier Biomedical R&D Institute. They are certified by one of the world's leading energy conservation and environmental protection organisations.



DW-86L829BP



#### Intelligent frequency Conversion technology

Two variable speed compressors are controlled for optimal freezer performance. Low energy consumption is achieved.



#### Maximum energy efficiency

Our SmartFrequency Technology, coupled with our environmentally safe and friendly hydrocarbon refrigeration system, allows the Haier freezers to operate at a low level of energy of 8.2 kWh/day.

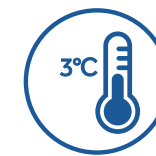

#### Precise temperature control

The innovative control algorithm balances the effects of temperature loss with the unique frequency conversion refrigeration system, ensuring the cabinet temperature stability of  $\pm 3^{\circ}\text{C}$ .



#### Frequency conversion Adaptive technology

Variable speed compressors in Haier Biomedical freezers are operated to produce the capacity that matches the demand of the load. The control system automatically tunes the speed of the compressors to optimize the operation.



#### World-leading energy saving Refrigeration technology

Our hydrocarbon refrigeration technology can save energy by 50%, significantly reducing operator's cost. The refrigerants do not contain fluoride and chloride. The global warming potential is extremely low at 3. Thus they are very friendly to the environment.



#### Minimal sound level output

Adaptive control technology controls the fans and compressors to reduce the sound level to 43.5 dB(A).



**Energy Saving Refrigeration**  
High efficiency cooling fans and compressors, combined with hydrocarbon refrigerants, ensure energy savings and long-term sample security

**Multilayered Sealing Structure**  
Four layer of gaskets split between main and inner doors decreases heat loss and guarantee excellent warm up times in the event of a power failure

**Pressure Equalisation Port**  
Heated port with spring assisted mechanism to prevent icing on the vent allows users to reopen the main door soon after entering. Adopts chromium plating, rust-proof

**Improved Handle Design**  
Lockable handle with unique key prevents other Haier freezer owner's access to your precious samples, also comes with space for a padlock for that extra security

**USB Interface**  
Enables users to download historical temperature data for compliance/auditing purposes

**Multilevel Alarms**  
Alarming functions that include high and low temperature, sensor error, power failure, high ambient, clean filter and door ajar

DW-86L829BP

DW-86L829BP | TYPICAL PERFORMANCE CHARACTERISTICS AT 25°C AMBIENT

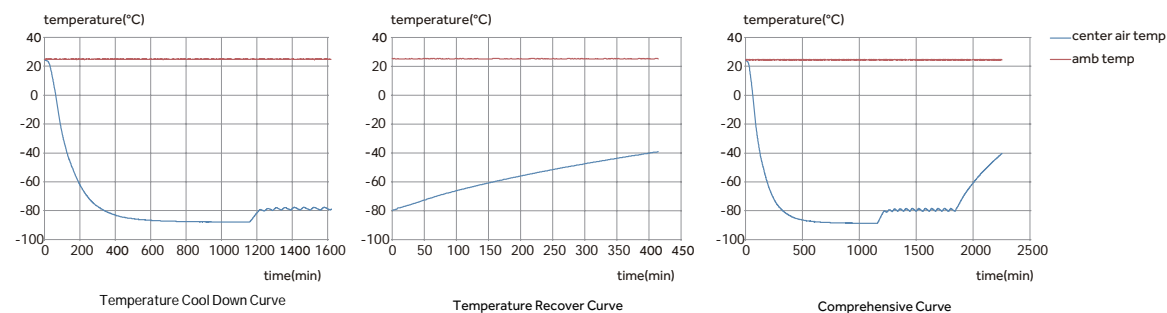

Specifications

	Model	DW-86L579BP	DW-86L729BP	DW-86L829BP	DW-86L959BP		
Technical Data	Cabinet Type	Upright	Upright	Upright	Upright		
	Climate Class	N	N	N	N		
	Cooling Type	Direct Cooling	Direct Cooling	Direct Cooling	Direct Cooling		
	Defrost Mode	Manual	Manual	Manual	Manual		
	Refrigerant	HC	HC	HC	HC		
Performance	Sound Level (dB(A))	43.5	43.5	43.5	47		
	Cooling Performance (°C)	-86	-86	-86	-86		
Control	Temp Range (°C)	-40~-86	-40~-86	-40~-86	-40~-86		
	Controller	Microprocessor	Microprocessor	Microprocessor	Microprocessor		
Electrical Data	Display	LED	LED	LED	LED		
	Power Supply (V/Hz)	100~230/50/60	100~230/50/60	100-230/50/60 208-230/50/60	100-230/50/60 208-230/50/60		
Construction	Electrical Current (A)	14	14	15	6	20	7
	Capacity (L/Cu.Ft)	579/20.4	729/25.7	829/29.2	959/33.9		
	Net/Gross Weight (approx)	kg	325/355	350/385	380/415	450/485	
		lbs	716.5/782.6	771.6/848.8	837.7/914.9	992.1/1069.2	
	Interior Dimensions (W*D*H)	mm	620*716*1310	766*716*1310	870*716*1310	1016*716*1310	
		in	24.4*28.2*51.6	30.2*28.2*51.6	34.3*28.2*51.6	40.0*28.2*51.6	
Exterior Dimensions (W*D*H)	mm	895*998*1980	1046*998*1980	1145*998*1980	1296*998*1980		
	in	35.2*39.3*78.0	41.2*39.3*78.0	45.1*39.3*78.0	51.0*39.3*78.0		
Packing Dimension (W*D*H)	mm	975*1095*2130	1120*1090*2130	1240*1080*2130	1410*1160*2185		
	in	38.4*43.1*83.9	44.1*42.9*83.9	48.8*42.5*83.9	55.5*45.7*86.0		
Loading Quantities	Container Load (20'/40'/40'H)	12/24/24	10/22/22	5/11/11	5/10/10		
	Remote Alarm (Dry contacts)	Y	Y	Y	Y		
	High/Low Temp	Y	Y	Y	Y		
	Hot Condenser	Y	Y	Y	Y		
Alarms	Power Failure	Y	Y	Y	Y		
	Sensor Error	Y	Y	Y	Y		
	Low Battery	Y	Y	Y	Y		
	High Ambient Temp	Y	Y	Y	Y		
	Door Ajar	Y	Y	Y	Y		
	Caster	Y	Y	Y	Y		
	Foot	Y	Y	Y	Y		
	Porthole	Y/2	Y/2	Y/2	Y/2		
Accessories	Shelves/ Inner Doors	3/4	3/4	3/4	3/4		
	USB Interface	Y	Y	Y	Y		
	5V Power Supply Port	Y	Y	Y	Y		
	Temp Recorder	Optional	Optional	Optional	Optional		
	RS485 Port	Y	Y	Y	Y		
	CO <sub>2</sub> Backup System	Optional	Optional	Optional	Optional		
	LN <sub>2</sub> Backup System	Optional	Optional	Optional	Optional		
	CE	Y	Y	/	Y	/	Y
Certifications	UL	Y	Y	Y	/	Y	/
	ENERGYSTAR	Y	Y	Y	Y	Y	Y

BP suffix - Variable frequency inverter compressor  
Product appearance and specifications are subject to change without notice

Haier Biomedical water-cooled ULT freezers are designed to meet strict requirements for storage of plasma, biological materials, vaccines, reagents, specimens, and other valuable samples. They are ideal for installations in hospitals, clinics, blood banks and medical research facilities where freezer heat must be removed by cooling water.



### Advantages

- Intelligent frequency conversion technology
- Advanced control Touchscreen
- Higher efficiency to yield more energy savings of up to 20%
- Approximately 90% of the compressor heat generated during operation is removed by the cooling water, thus posting little impact to a laboratory's ambient
- Use less air-conditioning power for a comfortable laboratory condition
- Advanced control
- Low sound level
- Smart coolant control
- High quality industry grade hermetically sealed compressors
- Pressure protection system due to lack of water flow



### Specifications

Model		DW-86L828W	DW-86L959W	
Technical Data	Cabinet Type	Upright	Upright	
	Climate Class	N	N	
	Cooling Type	Direct cooling	Direct cooling	
	Defrost Mode	Manual	Manual	
	Refrigerant	HC	HC	
	Sound Level (dB(A))	43.5	47	
Performance	Cooling Performance (°C)	-86	-86	
	Temperature Range (°C)	-40~-86	-40~-86	
Control	Controller	Microprocessor	Microprocessor	
	Display	LCD Touch Screen	LCD Touch Screen	
Electrical Data	Power Supply (V/Hz)	208-230/50/60	208-230/50/60	
	Electrical Current (A)	6	7	
	Capacity (L/Cu.Ft)	828/29.2	959/33.9	
Dimensions	Net/Gross Weight (approx)	kg	380/415	450/485
		lbs	837.7/914.9	992.1/1069.2
	Interior Dimension (W*D*H)	mm	870*716*1310	1016*716*1310
		in	34.3*28.2*51.6	40.0*28.2*51.6
	Exterior Dimension(W*D*H)	mm	1145*998*1980	1296*998*1980
		in	45.1*39.3*78.0	51.0*39.3*78.0
	Packing Dimension (W*D*H)	mm	1240*1080*2130	1410*1160*2185
		in	48.8*42.5*83.9	55.5*45.7*86.0
	Container Load (20'/40'/40'H)		5/11/11	5/10/10
	Alarms	High/Low Temperature	Y	Y
Hot Condenser		Y	Y	
Power Failure		Y	Y	
High/Low Voltage		Y	Y	
Sensor Error		Y	Y	
Low Battery		Y	Y	
High Ambient Temperature		Y	Y	
Door Ajar		Y	Y	
Caster		Y	Y	
Foot		Y	Y	
Accessories	Porthole	Y/2	Y/2	
	Shelves/Inner doors	3/4	3/4	
	USB Interface	Y	Y	
	Remote Alarm (Dry contacts)	Y	Y	
	5V Power Supply Port	Y	Y	
	Temperature Recorder	Optional	Optional	
	Rs485 Port	Y	Y	
	CO <sub>2</sub> Backup System	Optional	Optional	
	LN <sub>2</sub> Backup System	Optional	Optional	
	Others	Certification	CE	CE



Haier Biomedical Salvum brand of ULT freezers has been designed to deliver energy savings and reduced carbon footprint. This range uses environmentally safe hydrocarbon refrigerants and high efficiency fan motors to maximize the cooling ability of the system and reduce energy consumption. While providing sample safety, the freezer design makes energy savings possible for laboratories.



DW-86L829



DW-86L579



### Large Intelligent LCD Screen Visual Management

10-inch high-performance LCD capacitive screen, sensitive touch operation; intuitive display of inside temperature, ambient temperature, input voltage and other data and temperature curves.

### Inventory Management System

The single version of the inventory management allows users who do not have a racking system within the freezer to easily record item locations, entry and exit records.

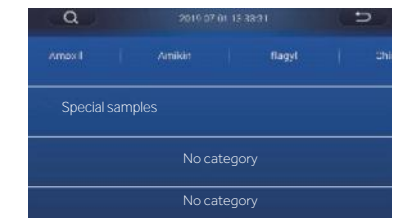

Single version (standard)



Professional version(optional)

In instances where customers use racking systems, the optional professional version of the inventory management is available. Freezer racks, boxes, and vials can easily record item locations and entry and exit records, facilitate item inventory and statistics, realize multi-screen interaction and reduce errors through secondary verification.

The freezer comes with the single version as standard.

### Equipped with Multiple Interfaces

- Standard USB interface, capable of storing data for 10 years
- Standard remote alarm terminal RS485 port

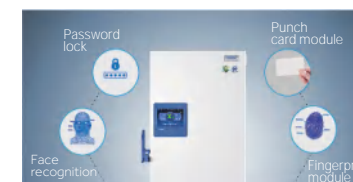

### Multiple Options for Safe Management and Control Systems

Standard password lock, optional fingerprint module, punch card module, face recognition, realizing safe and secure multi-user management.

### Optional IoT System Realizes Real-time Monitoring

The IoT APP can monitor the operating status of the equipment anytime and anywhere. Equipped with multiple alarm functions and able to self-diagnose system faults to ensure sample safety. (Contact your local area representative to check local availability.)



### Safe and Secure with Multiple Alarms

Multiple alarm functions include high temperature alarm, low temperature alarm, sensor failure alarm, power failure alarm, low battery alarm, door ajar alarm and high ambient temperature alarm.

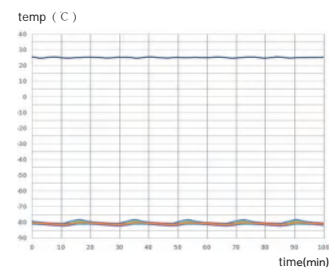

### Precise Temperature Control Ensures Safe Storage

Adjustable temperature set-point between -40°C ~ -86°C and the ability to monitor temperature curves in real time, equipped with sophisticated temperature safety alarm system to ensure product safety.

### Ergonomic Design



#### Narrow Door Design

The freezer can pass through an 750mm wide door when the door is open



#### New Handle Design

Adopting exclusive slide design, easy to open and close the door



#### Pressure Equalization Port

Equipped with pressure equalization port, realize easy opening  
Adopts chromium plating, rust-proof



#### Porthole

Two portholes as standard, allows for independent testing of cabinet temperature



#### Filter Design

Tool-free removable filter design, easy and quick to clean the filter



#### Detachable Inner Door Design

Tool-free detachable inner door, realizing easy and quick defrost

### Specifications

Model	DW-86L419	DW-86L579	DW-86L729	DW-86L829		
Technical Data	Cabinet Type	Upright	Upright	Upright	Upright	
	Climate Class	N	N	N	N	
	Cooling Type	Direct cooling	Direct cooling	Direct cooling	Direct cooling	
	Defrost Mode	Manual	Manual	Manual	Manual	
	Refrigerant	HC	HC	HC	HC	
	Sound Level (dB(A))	47	47	52	52	
Performance	Cooling Performance (°C)	-86	-86	-86	-86	
	Temp Range (°C)	-40~-86	-40~-86	-40~-86	-40~-86	
Control	Controller	Microprocessor	Microprocessor	Microprocessor	Microprocessor	
	Display	LCD Touchscreen	LCD Touchscreen	LCD Touchscreen	LCD Touchscreen	
Electrical Data	Power Supply (V/Hz)	220-240/50	220-240/50	220-240/50	220-240/50	
	Electrical Current (A)	5	5.5	9	10	
Construction	Capacity (L/Cu.Ft)	419/14.8	579/20.45	729/25.75	829/29.3	
	Net/Gross Weight (approx)	kg	255/286	300/330	350/385	380/410
		lbs	562.2/630.5	661.4/727.5	771.6/848.8	837.7/903.9
	Interior Dimensions (W*D*H)	mm	465*716*1310	620*716*1310	766*716*1310	870*716*1310
		in	18.3*28.2*51.6	24.4*28.2*51.6	30.2*28.2*51.6	34.3*28.2*51.6
	Exterior Dimensions (W*D*H)	mm	830*980*1980	903*980*1960	1049*980*1980	1153*980*1980
in		32.7*38.6*78.0	35.6*38.6*77.2	41.3*38.6*78.0	45.4*38.6*78.0	
Packing Dimension (W*D*H)	mm	890*1090*2130	975*1095*2130	1120*1090*2130	1240*1080*2130	
	in	35.0*42.9*83.9	38.4*43.1*83.9	44.1*42.9*83.9	48.8*42.5*83.9	
Loading Quantities	Container Load (20'/40'/40'H)	12/26/26	12/24/24	10/22/22	5/11/11	
Alarms	High/Low Temp	Y	Y	Y	Y	
	Hot Condenser	Y	Y	Y	Y	
	Power Failure	Y	Y	Y	Y	
	High/Low Voltage	Y	Y	Y	Y	
	Sensor Error	Y	Y	Y	Y	
	Low Battery	Y	Y	Y	Y	
	High Ambient Temp	Y	Y	Y	Y	
	Door Ajar	Y	Y	Y	Y	
Accessories	Caster	Y	Y	Y	Y	
	Foot	Y	Y	Y	Y	
	Porthole	Y/2	Y/2	Y/2	Y/2	
	Shelves/ Inner Doors	3/2	3/4	3/4	3/4	
	USB Interface	Y	Y	Y	Y	
	Remote Alarm (Dry contacts)	Y	Y	Y	Y	
	5V Power Supply Port	Y	Y	Y	Y	
	Temp Recorder	Optional	Optional	Optional	Optional	
	RS485 Port	Y	Y	Y	Y	
	CO <sub>2</sub> Backup System	Optional	Optional	Optional	Optional	
	LN <sub>2</sub> Backup System	Optional	Optional	Optional	Optional	
	Certification	CE	Y	Y	Y	Y
Energy star		/	Y	Y	Y	

Product appearance and specifications are subject to change without notice



This product line is designed and manufactured for long term storage of various biological products, including viruses, germs, erythrocytes and leucocytes. Applications can be found in blood banks, hospitals, epidemic prevention services, research institutes, biological engineering institutes, laboratories in electronic and chemical plants.



### Advantages

- World leading energy-efficient
- Hydrocarbon refrigeration system
- Slim cabinet design
- Reliable sample protection
- Malfunction alarms
- Excellent insulation performance

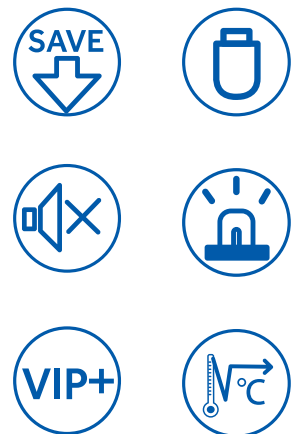

### Insulation and System Design

- Special V-I-P (Vacuum Insulation Panel) insulation system reduces the heat gain by 25%
- High efficiency HC refrigeration system improves the overall efficiency by 45%
- Four individual insulated inner doors reduce the cold air loss to the minimum
- Heated Pressure Equalization Port makes re-accessing the unit fast
- About 50 dba sound level

### Safe and Reliable Storage

- Superior temperature uniformity
- Dependable fans, compressors and other system related components

### Alarms (Visual and Audible)

- Adjustable High/Low temperature alarm
- Sensor error
- Low battery
- Door ajar
- Power failure
- Hot condenser
- High ambient
- Remote alarm contact

### Extended Warm up Time During Power Failure

- Warm up time measures the time taken for temperature to rise up (from -80°C to -50°C) at 25°C ambient when the power is interrupted.
- Haier has the longest warm up time when compared with other major brands in the market.

TYPICAL PERFORMANCE CHARACTERISTICS AT 25°C AMBIENT

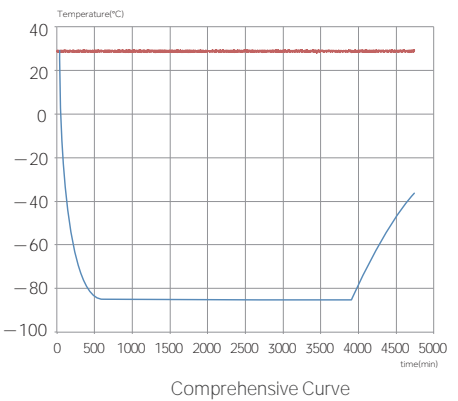
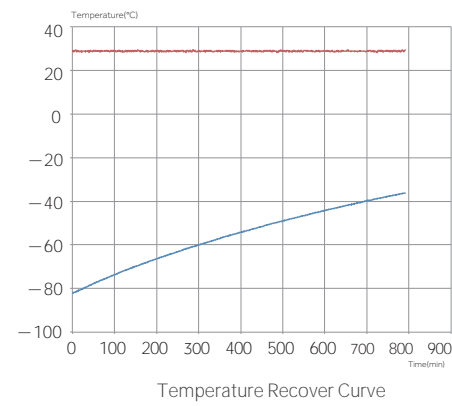
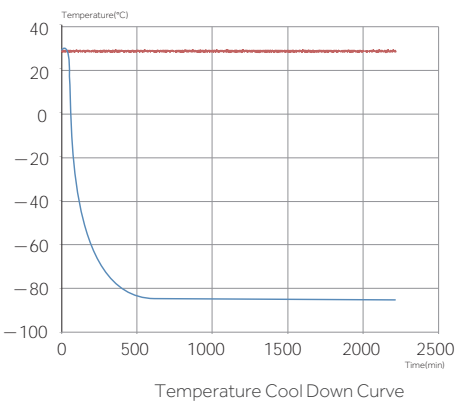

#### 4 Individual Removable Foam Inner Doors

- 4 individual inner doors can be opened independently to minimize frost buildup inside the chamber.
- Unique door seal design for the minimum loss of cold temperature during a door opening.
- Compatibility with existing racking system from competitors.
- Stainless steel handle to ensure proper strength for door latching.
- Some interior door handles have been upgraded to stainless steel for more comfortable door opening experience



#### Excellent Doors Seals

- Total of five gaskets to safeguard the freezer temperature, including four seals for the exterior door, one for each inner door



- Optimized slideway design, easier to open and close the door



#### Pressure Equalization Port

- Heated port with spring-assisted mechanism to prevent icing on the vent.
- Allows re-accessing the freezer after initial door opening.
- Adopts chromium plating, rust-proof

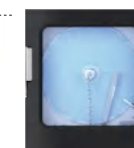

#### Circular- chart Recorder (Optional)

- Front-mounted.
- For independent temperature monitoring.



#### High Efficiency Refrigeration Components



Two port holes for ease of temperature monitoring



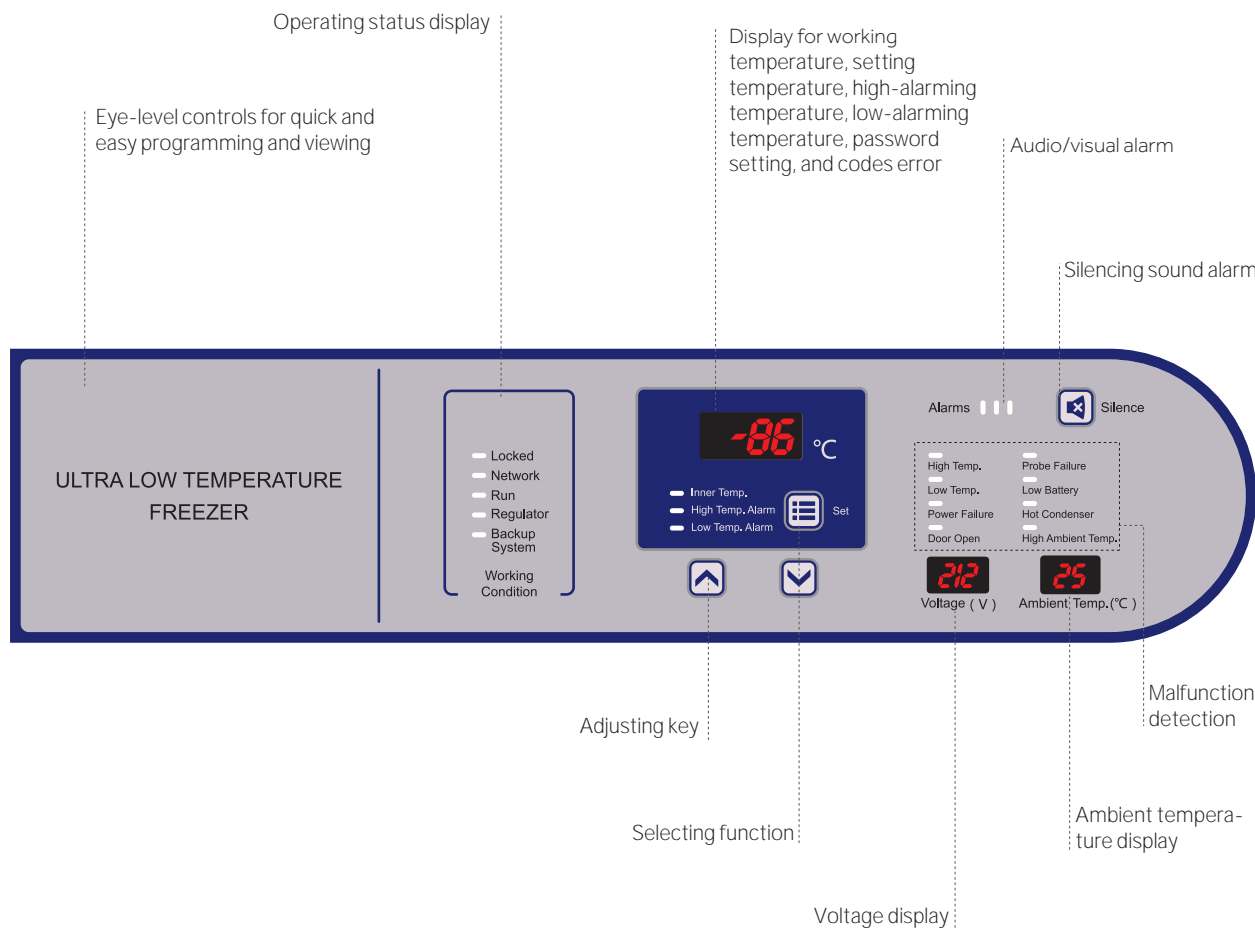

Specifications

Alarm	Alarm Triggering Condition
High Temperature	Temperature reaches the warm alarm limit
Low Temperature	Temperature reaches the low alarm limit
Power Failure	Equipment loses power
Door Ajar	Door opening time exceeds set time, settable between 0 and 20 minutes
Sensor Error	E0.Ambient sensor fails E1.Condenser sensor fails E2.Main cabinet temperature control sensor fails E3.Heat exchanger sensor fails E4.Heat exchanger temperature fails
Low Battery	Battery capacity runs low or battery switch is not turned on
Hot Condenser	1. Condensers filter element is clogged 2. Ambient temperature is too high
High Ambient Temperature	Ambient temperature exceeds 32°C



- Unique insulated inner door design for four separate storage compartments to minimize frost buildup inside the chamber
- Specialized control system design for a well-balanced operation of cascade refrigeration system
- Positive field proven reliability record



- Malfunction alarms including high and low temperature, power failure, sensor error, clean -filter, and extremely high ambient
- Capable of producing two types of alarm outputs: audible buzzer and visible flashing light
- Multiple built-in system protection features including user-settable protection code for controls, user settable delay to start, voltage compensation system, and protection against extreme high voltages
- Door open feature standard and USB port for temperature data downloading standard on upright models
- Remote alarm contacts



- Wide range operating voltage system from 185V to 260 V designed to allow units installed in areas with poor voltage condition
- Suitable for 10°C to 32°C ambient temperature
- Input voltage and ambient temperature shown simultaneously for ease of monitoring environmental conditions
- Robust door latch designed for secure door closing
- Compact casters for ease of maneuvering



- Specialized refrigeration system design using whisper quiet fan and compressors
- Freezer chassis designed to absorb vibration and sound









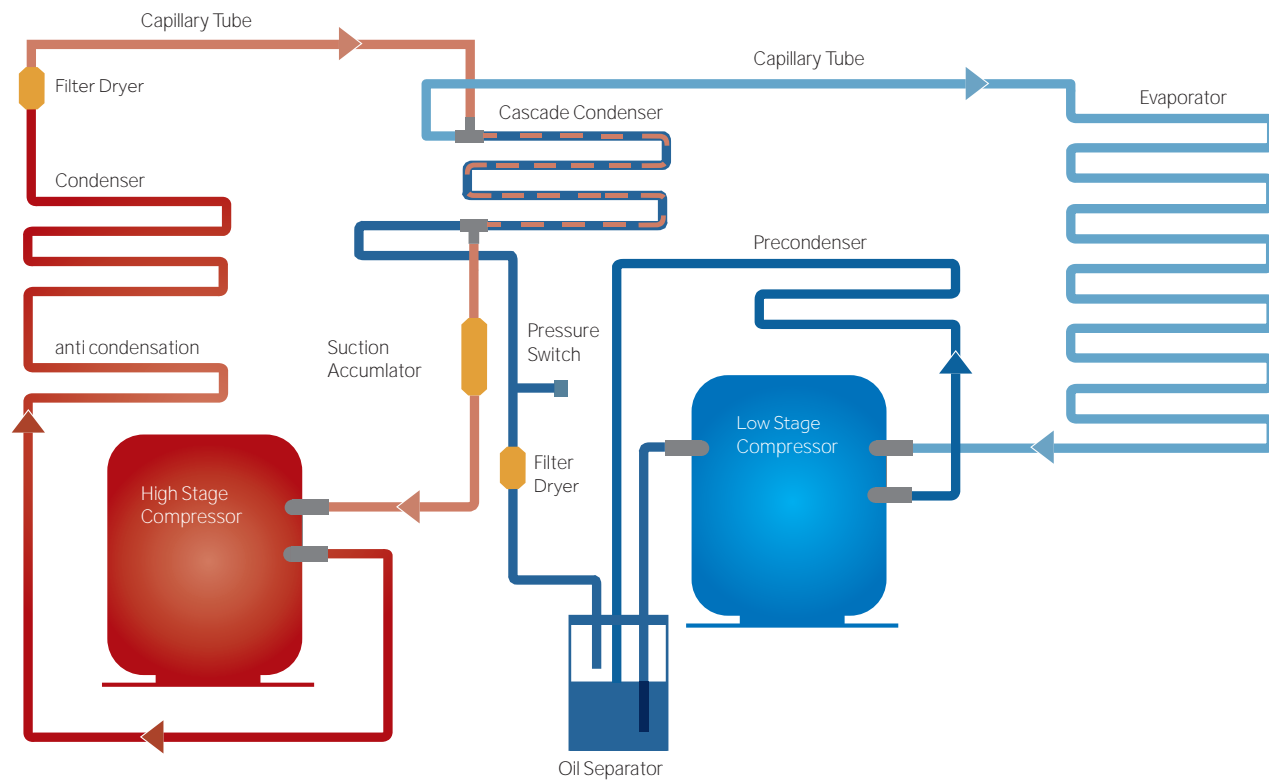

- Unique door seal design for the minimum loss of cold temperature during a door opening
- High performance VIP insulation panels to minimize cabinet heat gain and to improve temperature stability
- Patented cabinet insulation system designed for optimal performance of cold storage temperature and minimal frost buildup
- Unique design of independent insulated inner door systems for independent access of storage space to provide the maximum protection of stored samples



- Microprocessor-controlled system designed for controllable range of -40°C to -86°C for cabinet space with 1°C increment
- Large LED display for cabinet temperature, set temperature, ambient temperature, and input voltage
- Settable high temperature and low temperature alarms
- Automatic clean-filter alarm and sensor error alert
- Adjustable storage shelf height
- Optional temperature recorder, storage racks and storage boxes



	<b>Filter dryer</b> • Filtration and drying device for water and debris
	<b>Capillary tube for high stage</b> • Expansion device for high stage liquid refrigerant
	<b>Capillary tube for low stage</b> • Expansion device for low stage refrigerant
	<b>High stage condenser</b> • Extra-large air cooled condenser dissipates product heat content efficiently.
	<b>Low stage evaporator</b> • Heat exchanger for expanded low stage refrigerant
	<b>Ultra low noise compressor</b> • Compressor provides reliable performance with ultra low noise • Specially designed low stage evaporator yields excellent temperature uniformity and recovery after loading and door opening. • Both high and low stage compressors are industrial grade hermetically sealed compressor designed for low temperature application. Sound level is extremely low.
	<b>Cascade condenser</b> • Heat exchanger between the high and low temperature stage in the system
	<b>Temprite oil separator</b> • Temprite oil separator can effectively separate oil and water to improve the refrigeration performance

Suitable for clinical, medical, scientific research, quarantine and other departments to store items under low temperature conditions. Applicable for universities, hospitals, disease prevention and control centers, blood stations, scientific research institutes, electronics and chemical enterprise laboratories and biomedical engineering research institutes. For storage of biological products and biological samples such as red and white blood cells, viruses, bone and bacteria. Also used for electronic devices and other materials used for cryogenic tests.



DW-86L100J



**Energy Efficient, Safe and Reliable**

High efficiency HC refrigeration system, optimised for energy efficiency delivering a power consumption figure of just 5.5kW/24hrs.



**Personal ULT Storage**

810mm cabinet height makes it easy to place on or under counter, saving storage space. Stackable design.



**Ergonomic design**

Ergonomic handle design ensures easy one-hand door opening.



**Low noise**

Optimized noise reduction cabinet and system design, emits sound level of only 46.8dB.



**VIP insulation and multilayered sealing design**

70mm insulating layer with 25mm VIP and 4 layers of gasket improves energy efficiency and reduces heat loss to deliver excellent warm up times in event of power failure.



**Optional IoT Module**

Real time monitoring of cabinet temperature, temperature setting, high and low temperature alarm value, temperature curve, alarm log and event log.

- User-settable parameters such as set point and alarms.
- Real-time cabinet temperature display, alarm information, power supply and compressor start/stop state.
- Standard USB port capable of storing >15 years of operating data for compliance.



Filter is easy to remove and clean without the need for tools.

4 casters + 2-foot locks, easy to move, lock and level.



Ergonomic design for easy door opening and closing. Lockable and equipped with 4 keys as standard with the ability to add a padlock for extra security when required.



Double stainless-steel inner doors to prevent cooling loss when opening the outer door, easy to clean.



**Microprocessor control system**

- Microcomputer electronic thermostat, LED temperature display, display precision 1°C, adjustable cabinet temperature set point -40°C--86°C.
- Cabinet temperature/voltage/ambient temperature checking are available.
- Multiple alarm functions: high temperature alarm, low temperature alarm, sensor fault alarm, power failure alarm, low battery power alarm, open door alarm and high ambient temperature alert.
- Sound and light alarm mode, attachable to remote alarm interface.
- Battery backup alarm function operates continuously for >24hrs in the event of a power outage.
- Standard configuration: RS485 port and USB interface.
- Standard 5V power supply available for test equipment.
- Optional IoT module.



**Superior thermal insulation performance**

70mm super thick insulation layer design, aviation vacuum insulation material VIP, thickness of 25 mm or more, 4 layers of silicone seal, superior thermal insulation and energy saving effect.



**Porthole**

Portholes as standard, allows for independent testing of cabinet temperature.



**Security lock**

Standard door lock and padlock to ensure sample security and prevent unauthorised access.



**USB data storage**

Capable of storing more than 15 years of data.

Specifications



	Model	DW-86L338J			DW-86L338JA			DW-86L388J			DW-86L486E			DW-86L490J			DW-86L490JA			DW-86L578J			DW-86L578JA			DW-86L628E												
Technical Data	Cabinet Type	Upright						Upright						Upright						Upright																		
	Climate Class	N						N						N						N																		
	Cooling Type	Direct cooling						Direct cooling						Direct cooling						Direct cooling																		
	Defrost Mode	Manual						Manual						Manual						Manual																		
	Refrigerant	HC						HC						HC						HC																		
	Sound level (dB(A))	50						50						49						50																		
Performance	Cooling Performance (°C)	-86						-86						-86						-86																		
	Temperature Range (°C)	-40~-86						-40~-86						-40~-86						-40~-86																		
Control	Controller	Microprocessor						Microprocessor						Microprocessor						Microprocessor																		
	Display	LED						LED						LED						LED																		
Electrical Data	Power Supply (V/Hz)	220~240/50		120/60		208~230/60		220~240/50			220~240/50			220~240/50		208~230/60		220~240/50		120/60		208~230/60		220~240/50														
	Electrical Current (A)	7.5		12		7.5		7.5			10			8		8		7.5		12		9		11														
Construction	Capacity (L/Cu.Ft)	338/11.9						388/13.7						486/17.1						490/17.3						578/20.4						626/22.1						
	Net/Gross Weight (approx)	kg	238/278						255/286						290/310						295/335						300/330						301/323					
		lbs	524.7/612.9						562.2/630.5						639.3/683.4						650.4/738.5						661.4/727.5						664.0/712.0					
	Interior Dimension (W*D*H)	mm	465*630*1165						465*716*1310						590*630*1310						590*630*1310						620*716*1310						760*630*1310					
		in	18.3*24.8*45.9						18.3*28.2*51.6						23.3*24.8*51.6						23.2*24.8*51.6						24.4*28.2*51.6						29.9*24.8*51.6					
	Exterior Dimension (W*D*H)	mm	823*900*1871						830*980*1980						953*900*1980						873*900*1980						903*980*1960						1035*900*1980					
in		32.4*35.4*73.6						32.7*38.6*78.0						37.5*35.4*78.0						34.4*35.4*78.0						35.6*38.6*77.2						40.7*35.4*78.0						
Packing Dimension (W*D*H)	mm	887*995*2040						890*1090*2130						1020*1020*2130						920*990*2130						970*1085*2130						1110*1005*2130						
	in	34.9*39.2*80.3						35.0*42.9*83.9						40.2*40.2*83.9						35.2*39.0*83.9						38.2*42.7*83.9						43.7*39.6*83.9						
Loading Quantities	Container load (20'/40'/40'H)	12/26/26						12/26/26						10/22/22						12/26/26						12/24/24						12/24/24						
Alarms	High/Low Temperature	Y						Y						Y						Y						Y												
	Hot Condenser	Y						Y						Y						Y						Y												
	Power Failure	Y						Y						Y						Y						Y												
	Sensor Error	Y						Y						Y						Y						Y												
	Low Battery	Y						Y						Y						Y						Y												
	High Ambient Temperature	Y						Y						Y						Y						Y												
	Door Ajar	Y						Y						Y						Y						Y												
Accessories	Caster	Y						Y						Y						Y						Y												
	Foot	Y						Y						Y						Y						Y												
	Porthole	Y/2						Y/2						Y/2						Y/2						Y/2												
	Shelves/Inner doors	3/2						3/2						3/4						3/4						3/4												
	USB Interface	Y						Y						Y						Y						Y												
	Remote Alarm (Dry contacts)	Y						Y						Y						Y						Y												
	5V Power Supply Port	Y						Y						Y						Y						Y												
	Temperature Recorder	Optional						Optional						Optional						Optional						Optional												
	RS232/485 Port	Optional						Optional						Optional						Optional						Optional												
CO2 Backup System	Optional						Optional						Optional						Optional						Optional													
LN2 Backup System	Optional						Optional						Optional						Optional						Optional													
Certifications	CE	Y	/	/	Y	Y	Y	Y	Y	Y	Y	Y	Y	Y	Y	Y	Y	Y	Y	Y	Y	Y	Y	Y	Y	Y												
	UL	/	Y	Y	/	/	/	/	/	/	/	/	/	/	Y	Y	/	/	Y	Y	Y	Y	Y	Y	Y	/												
	ENERGYSTAR	/	/	/	/	/	/	/	/	/	/	/	/	/	/	/	/	Y	Y	/	/	/	/	/	/	/												

· Product appearance and specifications are subject to change without notice  
 · DW-86L338J/490J/578/628/959 stainless steel interior optional



Specifications



	Model	DW-86L728J			DW-86L728JA		DW-86L828J		DW-86L828JA		DW-86L100J		DW-86W100J		DW-86W420J		DW-86W420JA		
Technical Data	Cabinet Type	Upright			Upright		Upright		Upright		Chest		Chest		Chest		Chest		
	Climate Class	N			N		N		N		N		N		N		N		
	Cooling Type	Direct cooling			Direct cooling		Direct cooling		Direct cooling		Direct cooling		Direct cooling		Direct cooling		Direct cooling		
	Defrost Mode	Manual			Manual		Manual		Manual		Manual		Manual		Manual		Manual		
	Refrigerant	HC			HC		HC		HC		HC		HC		HC		HC		
	Sound level (dB(A))	50			50		51.5		46.8		49		50		49		50		
Performance	Cooling Performance (°C)	-86			-86		-86		-86		-86		-86		-86		-86		
	Temperature Range (°C)	-40~-86			-40~-86		-40~-86		-40~-86		-40~-86		-40~-86		-40~-86		-40~-86		
Control	Controller	Microprocessor			Microprocessor		Microprocessor		Microprocessor		Microprocessor		Microprocessor		Microprocessor		Microprocessor		
	Display	LED			LED		LED		LED		LED		LED		LED		LED		
Electrical Data	Power Supply (V/Hz)	220~240/50	120/60	208~230/60	220~240/50	208~230/60	220~240/50	120/60	220~240/50	120/60	220~240/50	220~240/50	208~230/60	220~240/50	208~230/60	220~240/50	208~230/60		
	Electrical Current (A)	10	18	10	10	10	3	6.5	4	7.5	4	7.5	4	7.5	4	7.5	4		
Construction	Capacity (L/Cu.Ft)	728/25.7			828/29.2		100/3.5		100/3.5		100/3.5		100/3.5		420/14.8		420/14.8		
	Net/Gross Weight (approx)	kg	345/385			380/410		108/132		108/132		138/160		138/160		310/357		310/357	
		lbs	760.6/848.8			837.7/903.9		238/291		238/291		304.2/352.7		304.2/352.7		683.4/787.0		683.4/787.0	
	Interior Dimension (W*D*H)	mm	766*716*1310			870*716*1310		330*481*630		330*481*630		470*450*480		470*450*480		1367*462*652		1367*462*652	
		in	30.2*28.2*51.6			34.3*28.2*51.6		13*19*25		13*19*25		18.5*17.7*18.9		18.5*17.7*18.9		53.8*18.2*25.7		53.8*18.2*25.7	
	Exterior Dimension (W*D*H)	mm	1049*980*1980			1145*980*1980		770*660*810		770*660*810		769*825*1120		769*825*1120		2130*870*1020		2130*870*1020	
in		41.3*38.6*78.0			45.1*38.6*78.0		30*26*32		30*26*32		30.3*32.5*44.1		30.3*32.5*44.1		83.9*34.3*40.2		83.9*34.3*40.2		
Packing Dimension (W*D*H)	mm	1120*1090*2130			1240*1080*2130		865*755*1020		865*755*1020		860*880*1310		860*880*1310		2230*930*1180		2230*930*1180		
	in	44.1*42.9*83.9			48.8*42.5*83.9		34.1*29.7*40.2		34.1*29.7*40.2		33.9*34.6*51.6		33.9*34.6*51.6		87.8*36.6*46.5		87.8*36.6*46.5		
Loading Quantities	Container load (20'/40'/40'H)	10/22/22			5/11/11		32/64/64		32/64/64		14/28/56		14/28/56		12/26/26		12/26/26		
Alarms	High/Low Temperature	Y			Y		Y		Y		Y		Y		Y		Y		
	Hot Condenser	Y			Y		Y		Y		Y		Y		Y		Y		
	Power Failure	Y			Y		Y		Y		Y		Y		Y		Y		
	High/Low Voltage	/			/		/		/		/		/		/		/		
	Sensor Error	Y			Y		Y		Y		Y		Y		Y		Y		
	Low Battery	Y			Y		Y		Y		Y		Y		Y		Y		
	High Ambient Temperature	Y			Y		Y		Y		Y		Y		Y		Y		
	Door Ajar	Y			Y		Y		Y		Y		Y		Y		Y		
Accessories	Caster	Y			Y		Y		Y		Y		Y		Y		Y		
	Foot	Y			Y		Y		Y		Y		Y		Y		Y		
	Porthole	Y/2			Y/2		Y/1		Y/1		Y/1		Y/1		Y/1		Y/1		
	Shelves/Inner doors	3/4			3/4		1/2		1/2		-/1		-/1		-/3		-/3		
	USB Interface	Y			Y		Y		Y		Y		Y		Y		Y		
	Remote Alarm	Y			Y		Y		Y		Y		Y		Y		Y		
	5V Power Supply Port	Y			Y		Y		Y		N/A		N/A		N/A		N/A		
	Temperature Recorder	Optional			Optional		/		/		Optional		Optional		Optional		Optional		
	Rs232/485 Interface	Optional			Optional		NA/Y		NA/Y		Optional		Optional		Optional		Optional		
	CO <sub>2</sub> Backup System	Optional			Optional		Optional		Optional		Optional		Optional		Optional		Optional		
LN <sub>2</sub> Backup System	Optional			Optional		Optional		Optional		Optional		Optional		Optional		Optional			
Certifications	CE	Y	/	/	Y	/	Y	/	Y	/	Y	/	Y	/	Y	/	Y	/	
	UL	/	Y	Y	/	Y	/	Y	/	Y	/	Y	/	Y	/	Y	/	Y	
	ENERGY STAR	/	Y	/	/	Y	/	Y	/	Y	/	Y	/	Y	/	Y	/	Y	

Suitable for pharmaceutical, clinical and medical research use, for the long-term storage of samples and products under ultra-low temperature conditions.

Advantage



Microprocessor Control System

Microprocessor control, with temperature display precision at 0.1°C. Internal temperature is adjustable from of -40°C ~ -86°C

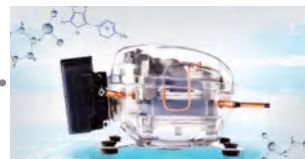

Auto-cascade Hydrocarbon (HC) Refrigeration Technology

Utilizing auto-cascade hydrocarbon compressor, with superior refrigeration and energy saving effect



Excellent Doors Seals

Total six gaskets to safeguard the freezer temperature, including a 70mm insulation layer, a 25mm vacuum VIP and 4 layers of silicone seal



Stainless Steel Inner Door

Prevents loss of internal air to keep samples safe



Ergonomic Design

Unique hook slide handle design, allows users to open and close the door with one hand



Porthole

One porthole as standard, allows for independent testing of cabinet temperature

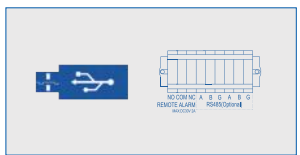

Multiple Ports

Enables users to download historical temperature data (up to 15 years) Equipped with remote alarm function and RS485 port



Quick Access Filter Design

Tool-free removable filter design, easy and quick to clean the filter



DW86L51J

Advantage



DW-80WZ15



HC Energy Saving

High quality HC high-efficiency compressor with optimized refrigeration system, which can save 50% on power consumption.



One Unit for Multiple Applications

\*Vehicle-mounted transportation with 24V(DC) power supply  
\*Long-term storage with 110V power supply.



Superior Uniformity

Built-in evaporator, fast cool down refrigeration, the temperature is safe, secure and reliable with the uniformity of ±3°C at key characteristic points.

Flexible, Portable Mini-ULT Freezer

Ergonomic Design



Light Weight

The whole unit weighs 27kg, easy to carry.



Superior Insulation Performance

25mm VIP + 70mm thick LBA foam insulation layer design, dual seal strips for better insulation.



Safety Lock Catch

Simple adjustable mechanical lock with lock catch, and it can be equipped with an external lock to guarantee the safety of sample transportation and storage.



Metal Handle

Hidden metal handle, stylish and comfortable, safe and durable, easy to carry.

Specifications

Model	DW-80WZ15		DW-86L51J	
Cabinet Type	Chest		Upright	
Climate Class	N		N	
Cooling Type	Direct Cooling		Direct Cooling	
Defrost Mode	Manual		Manual	
Refrigerant	HC		HC	
Sound Level (dB(A))	60		46.8	
Cooling Performance (°C)	-80		-86	
Temperature Range (°C)	-60~-80		-40~-86	
Controller	Temperature Controller		Microprocessor	
Display	LED		LED	
Power Supply (V/Hz)	220/50, DC 24	110/60, DC 24	120/60	220~240/50
Electrical Current (A)	2.5, 12	4.5, 12	7.5	3
Capacity (L/Cu.Ft)	15/0.53		51/1.8	
Net/Gross Weight (approx)	(kg)	27/33	77/90	73/86
	(lbs)	59.52	169.8/198.4	160.9/189.6
Exterior Dimension (W*D*H)	(mm)	690*320*500	532*640*806	
	(in)	27.2*12.6*19.7	20.9*25.2*31.7	
Interior Dimension (W*D*H)	(mm)	260*180*330	330*481*316	
	(in)	10.2*7.1*13.0	13*16.5*12.4	
Packing Dimension (W*D*H)	(mm)	805*430*725	570*735*1100	
	(in)	31.7*17.0*28.5	22.4*28.9*43.3	
Cabinet Width (Without Handle and Hinge)	/		470	
Container Load (20'/40'/40'H)	105/210/210		60/126/126	
High/Low Temperature	Y		Y	
Hot Condenser	N		Y	
Power Failure	Y		Y	
High/Low Voltage	N		Y	
Sensor Error	Y		Y	
Low Battery	N		Y	
High Ambient Temperature	N		Y	
Door Ajar	N		Y	
Start-up Delay	/		Y	
Caster	N		Y	
Foot	Y		Y	
Porthole	N		Y/1	
Shelves/Basket	N/N		1/1	
USB Interface	N		Y	
Remote Alarm	N		Y	
RS232/485 Port	N		NA/Standard	
Certification	CE	UL	UL	CE

\*Haier Biomedical reserves the right to change products and specifications without prior notice.



Suitable for primary cells and cooling cells that are highly sensitive to temperature changes.

## Product Functions

**USB Interface**  
Easier to connect external modules such as printer and barcode reader

**Adjustable Feet**  
Convenient to adjust the height of machine

**Temperature Record**  
Information traceability: the frozen temperature curve and data can be transmitted to the computer for display, and PDF files can be generated synchronously for printing and archiving

**Handle**  
Easy to open and close the door, the user process is safer

**Lock**  
Ergonomic design, easy to operate

**Side-opening Door**  
Convenient access of frozen samples, suitable height

**Double Layer Sealing Structure**  
Good sealing performance

**Superior Insulation Performance**  
Environmental friendly polyurethane foam material has good thermal insulation performance

**Power Switch**  
Easy to operate, safe and reliable

**RS 232 Interface**

**Liquid nitrogen level monitoring port**

**Gas inlet**  
Pipe thread connection, safe and stable

**Pressure Relief Hole**  
When the inner pressure is too large, the pressure relief valve releases the pressure by itself to achieve the equilibrium state of internal and external pressure

**Power Connector**  
Plug and play

**Drain**

## Product Advantages

- Precise Temperature Control**
  - Fine temperature control, the temperature rises and fall rate can be controlled in a wide range, can achieve the cooling rate of 0.1-99°C/min
  - The double solenoid and jet ring valve design ensure stable temperature control to effectively reduce cell damage
  - Precise temperature control, ADCR control algorithm, temperature fluctuation range is  $\pm 0.5^{\circ}\text{C}$
- Ergonomic Design**
  - 7-inch touch LCD screen, easy to operate
  - Liquid nitrogen allowance warning: Real-time display of liquid nitrogen allowance, timely warning when it is lower than 20%
  - Single handle press lock, simple and labor-saving, locking function, and the safety of the test process is guaranteed
  - Equipped with a real-time temperature curve printer and electronically archived temperature records

## Standard System Consists of

- Controlled Rate Freezer
- LN<sub>2</sub> Container
- LN<sub>2</sub> Transfer Hose
- Sample Probe
- Printer



## Specifications

Model	Power Supply (V/Hz)	Rated Power (W)	Effective Volume (L)	Temperature Range (°C)
CJ-L37	230-50/60	1300	37	-180-50
Display Screen	Serial Port Form	Exterior Dimensions (W*D*H)(mm)	Interior Dimensions (W*D*H)(mm)	Net Weight (Kg)
7" colorful LCD touch screen	USB Interface/RS232 serial port	941*571*527	330/340/330	73

\*Haier Biomedical reserves the right to change products and specifications without prior notice.

## Advantage

- Small footprint, light and easy for installation
- User adjustable temperature setting
- Simple to program and operate
- Flexible – Can be installed on any ULT freezer, which has a port hole
- The CO<sub>2</sub> injection pipe is designed in combination of filter, to prevent the blockage of CO<sub>2</sub> back-up system

## Safety

- Liquid CO<sub>2</sub> test button to ensure the backup system is working
- Low CO<sub>2</sub> alarm system alerts the user when liquid CO<sub>2</sub> bottle is low in liquid level
- Ultra-low sound level compressors

## Reliability

- Stainless steel covering, more elegant
- Stainless steel input pipe design, allows for flexibility and ease of cylinder positioning
- Durable battery lasts up to 48 hours



## Specifications

	Model	HBX-IC
Technical Data	Climate Class	N
	Cooling Type	Direct cooling
	Refrigerant	CO <sub>2</sub>
Performance	Cooling Performance (°C)	-70
	Temperature Range (°C)	-40~-70
Control	Controller	Thermostat
	Display	LED
Electrical Data	Power Supply (V/Hz)	220-240/50
		208-230/60
	Power (W)	115/60
	Electrical Current (A)	20
Dimensions	Net/Gross Weight (approx)	11.2/14
		24.7/30.86
	Exterior Dimensions (W*D*H)	200*400*160
		7.8*15.7*6.3
	Packing Dimensions (W*D*H)	550*390*330
Alarms	CO <sub>2</sub> Margin Insufficient Alarm	21.7*15.4*13.0
		Y
		Y
		Y
		Y
		Y
Accessories	CO <sub>2</sub> Injection Test Button	Y
	Foot	4
Others	Certification	CE/UL

Product appearance and specifications are subject to change without notice



LN<sub>2</sub> backup cooling system is an independent refrigeration system generally used for a -150°C mechanical cryo freezer. When there is a loss of power or the temperature of the freezer rises to the high alarm set point, the LN<sub>2</sub> backup system can be automatically activated to inject LN<sub>2</sub> into the chamber to maintain the freezer temperature. The backup system operates on a rechargeable battery when there is a loss of mains power.

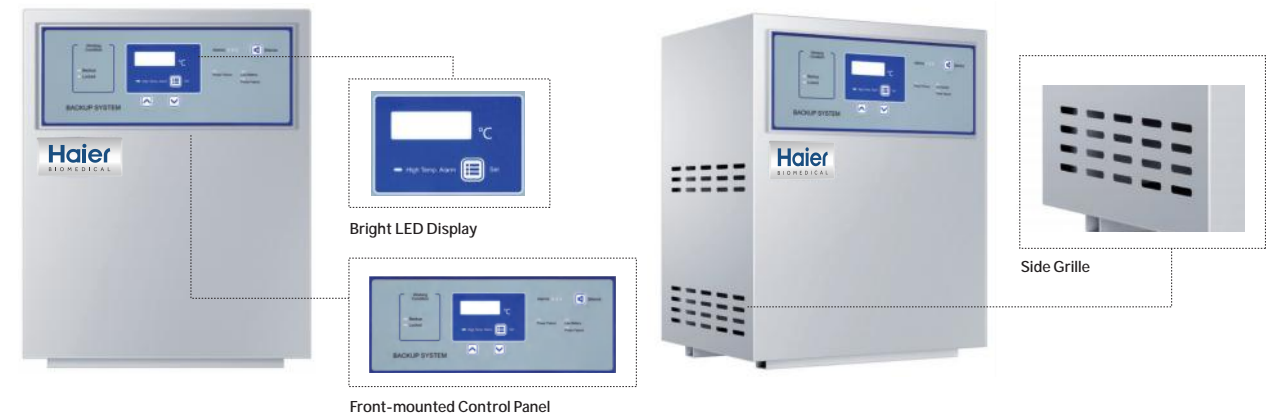

## Features

- Interlocked design to turn off the LN<sub>2</sub> injection when the door is opened
- Protection circuit to prevent over-charging battery
- Light weight and portable design, suitable for installation on top of a freezer
- Alarm functions to include low battery and sensor error

## Specifications

	Model	HBX-IIA
Technical Data	Cabinet Type	Horizontal
	Cooling Type	Direct cooling
	Refrigerant	LN <sub>2</sub>
Performance	Cooling performance (°C)	-135
	Temperature Range (°C)	-90~-135
Control	Controller	Thermostat
	Display	LED
Electrical Data	Power Supply (V/Hz)	220-240/50
		208-230/60
	Power (W)	115/60
Dimensions	Net/Gross Weight (approx)	20
		0.05
	Exterior Dimensions (W*D*H)	15/17
		33.1/37.5
	Packing Dimensions (W*D*H)	360*305*445
Alarms	Low Battery Alarm	14.2*12.0*17.5
		Y
	Sensor Error Alarm	450*375*720
		Y
Main Power Off Alarm	17.7*14.8*28.3	
	Y	
Charge Indicator	Y	
	CO <sub>2</sub> Injection Test Button	Y
Others	Certification	CE/UL

Product appearance and specifications are subject to change without notice



Applicable to biological research, medical laboratories for drying of biotechnological and pharmaceutical products, e.g. tissues and tissue extracts, bacteria, vaccines, and sera, also suitable to food research, chemical industry and other related scenarios for efficient lyophilization of samples.



DG-65Z04-10A

## Product Advantages



**Automatic parameter storage**  
Intelligent storage of the freeze-drying parameters, without setting them separately each time



**The refrigeration efficiency is greatly improved**  
The evaporator is located in the freezing chamber, which directly cools the sample and improves the refrigeration efficiency, it can reach -60°C within 25 minutes



**Integrated design and pollution-free, enclosed environment**  
The whole working cabin is closed, the freeze-drying process is isolated from the outside environment



**IoT real-time management**  
Separate account, authority management, configuration record function, data traceability, real-time monitoring of equipment status



**Multiple alarm functions**  
Multiple alarms including cold trap cooling overtime, vacuum pump oil replacement reminder, temperature sensor fault/cold trap temperature sensor fault, vacuum sensor fault, condenser sensor fault, ambient temperature sensor fault, abnormal refrigeration, motor overcurrent, condenser dirty blockage, vacuum alarm, heating lamp life less than 10% alarm



**High sublimation speed and high drying efficiency**  
Excellent temperature uniformity, free from external influences, more energy-saving and environment-friendly

## Friendly Design

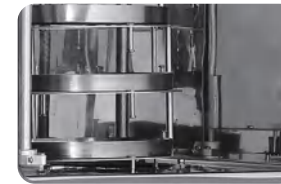

Automatic lifting shelves without manual operation



Vacuum pump port, convenient for oil change



The filter can be easily replaced

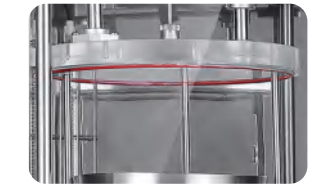

The design of glass door ensures the working situation in the drying chamber visible at a glance

## Product Parts

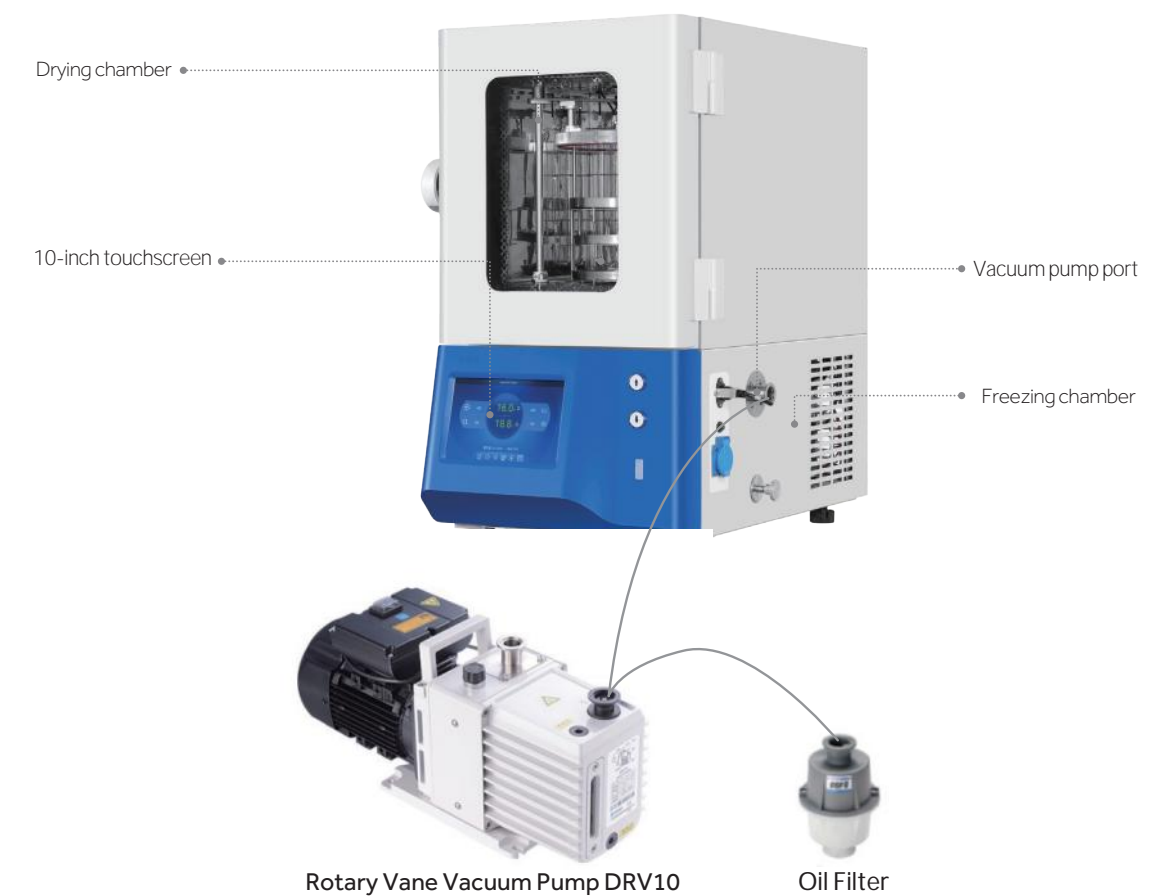

## Product Advantages

- Built in oil check valve to ensure no oil return in the pump
- No spring rotating disc, low noise, low vibration, and long service life
- Superior product structure, easy disassembly and assembly, fast and convenient maintenance
- Built in oil pump for forced oil supply, achieving long-term continuous and stable operation of the pump below atmospheric pressure
- The combination of various cooling methods such as air cooling, oil cooling, and water cooling ensures good cooling effect, achieving long-term stable operation of the product and stable evacuation performance

## Specifications

Model		DRV10
Power Supply (V/Hz)		220/50
Pumping Speed (m <sup>3</sup> /h)		9.9
Ultimate Pressure	Gas Ballast Off (Pa)	5*10 <sup>-1</sup>
	Gas Ballast On (Pa)	5
Motor Power (kw)		0.4
Required Oil (L)		1.1
Air Inlet		DN25KF
Air Outlet		DN25KF
Sound Level (db)		65
Weight (kg)		25

Model		DG-65Z04-10A
Ice Condenser Temperature (°C)		-65
Condensation Efficiency		4.5kg/24h
Sound Level (dB(A))		≤45
Weight (kg)		145 (equipment)+30 (pump)
Ultimate vacuum (Pa/mbar)		1/1*10 <sup>-2</sup>
Maximum Condensation (kg)		4
Power (w)		1000
Power Supply (V/Hz)		220/50
Dry Chamber Interior Dimension (W*D*H)(mm)		404*374*398
Dry Chamber Capacity (L)		60
Freeze Cabinet Capacity (L)		13
Area (m <sup>2</sup> )		0.1
Shelves		3 layers (extensive)
Material Tray Diameter (mm)		Φ200
Maximum Spacing Between Material Trays (mm)		70
Exterior Dimension (W*D*H)(mm)		480*793*883 (without pump)
Packing Dimension (W*D*H)(mm)		665*900*1400 (include pump)
Temperature Curve Display		Yes
Vacuum Pump Maintenance Reminder		Yes
Screen		10.1 inch touch screen
Notepad		Yes
Account Management		Yes
USB		Yes
IoT		Yes
Flask		/
Penicillin Bottle		/
Certification		CE

\*Haier Biomedical reserves the right to change products and specifications without prior notice.

Applicable to biological research, medical laboratories for drying of biotechnological and pharmaceutical products, e.g. tissues and tissue extracts, bacteria, vaccines, and sera. The product is also suitable to food research, chemical industry and other related scenarios for efficient lyophilization of samples.



DG-65Z04-10AR

## Product Advantages

**Automatic parameter storage**

Intelligent storage of the freeze-drying parameters, without setting them separately each time

**The refrigeration efficiency is greatly improved**

The evaporator is located in the freezing chamber, which directly cools the sample and improves the refrigeration efficiency, it can reach -60°C within 25 minutes

**IoT real-time management**

Separate account, authority management, configuration record function, data traceability, real-time monitoring of equipment status

**Multiple alarm functions**

Multiple alarms, including cold trap cooling overtime, vacuum pump oil replacement reminder, temperature sensor fault/cold trap temperature sensor fault, vacuum sensor fault, condenser sensor fault, ambient temperature sensor fault, abnormal refrigeration, motor overcurrent, condenser dirty blockage, vacuum alarm, heating lamp life less than 10% alarm

**Real time monitoring of freeze-drying status**

Check the sample freeze-drying curve at any time, and it can be adjusted immediately and in time if there are any risks



## Friendly Design



**Standard**

Able to pre-freeze, suitable for both plate and bottle samples



**Multi Manifold**

Able to pre-freeze, suitable for both plate and bottle samples, it's convenient for adding or taking samples during the freeze-drying process



**Pressure Plug**

Able to pre-freeze, suitable for bottled samples. After freeze-drying, it can be vacuum plugged manually



**Gland Multi Manifold**

Able to pre-freeze and vacuum plug, it's convenient for adding or taking samples during the freeze-drying process

## Product Parts

The glass design cover ensures the working situation in the drying chamber is visible at a glance

Large cold trap to meet a variety of sample pre-freezing requirements

The filter can be easily replaced

10-inch touch screen, users can view operating status, and historical temperature data and alarm events

Vacuum pump port, convenient for oil change

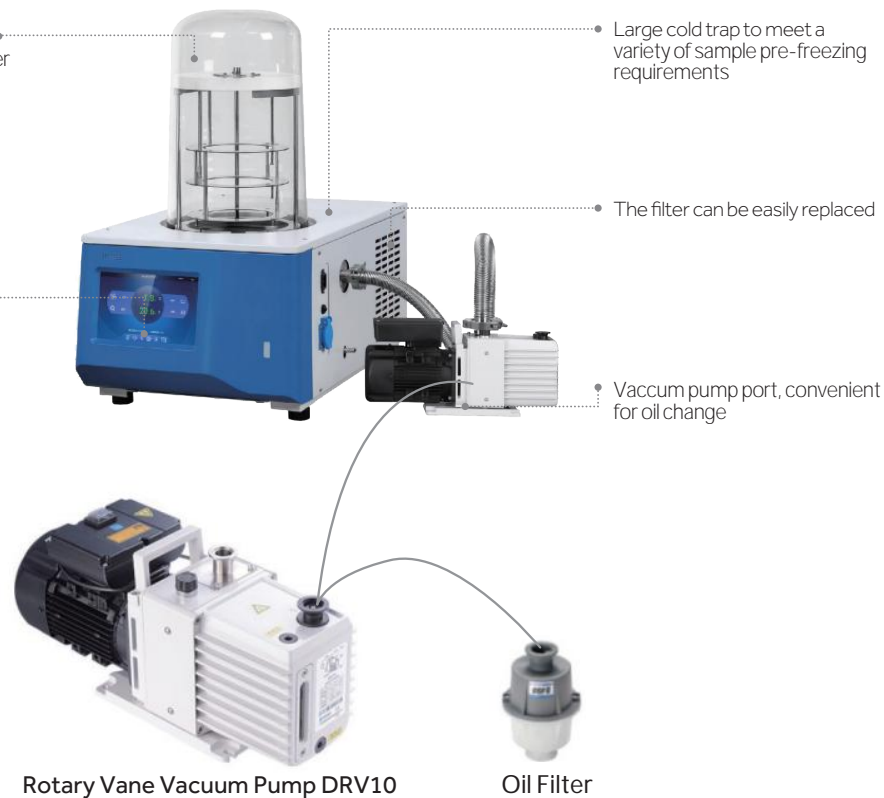

Rotary Vane Vacuum Pump DRV10

Oil Filter

## Specifications

Model		DRV10
Power Supply (V/Hz)		220/50
Pumping Speed (m <sup>3</sup> /h)		9.9
Ultimate Pressure	Gas Ballast Off (Pa)	5*10 <sup>-1</sup>
	Gas Ballast On (Pa)	5
Motor Power (kw)		0.4
Required Oil (L)		1.1
Air Inlet		DN25KF
Air Outlet		DN25KF
Sound Level (db)		65
Weight (kg)		25

Model		DG-65Z04-10AR
Ice Condenser Temperature (°C)		-65°C/-85°C (optional)
Condensation Efficiency		4.5kg/24h
Sound Level (dB(A))		≤60
Weight (kg)		65 (equipment)+30 (pump)
Ultimate vacuum (Pa/mbar)		1/1*10 <sup>-2</sup>
Maximum Condensation (kg)		4
Power (w)		1000
Power Supply (V/Hz)		220/50
Freeze Cabinet Capacity (L)		13
Area (m <sup>2</sup> )		0.1
Shelves		3 layers (extensive)
Material Tray Diameter (mm)		200
Maximum Spacing Between Material Trays (mm)		70
Exterior Dimension (W*D*H)(mm)		480*793*730 (without pump)
Packing Dimension (W*D*H)(mm)		685*920*940 (include pump)
Temperature Curve Display		Yes
Vacuum Pump Maintenance Reminder		Yes
Screen		10.1 inch touch screen
Notepad		Yes
Account Management		Yes
USB		Yes
IoT		Yes
Flask		Optional
Penicillin Bottle		Optional
Certification		CE

\*Haier Biomedical reserves the right to change products and specifications without prior notice.





## Lab Consumables Storage Solutions



# Freezer Storage Racks

Haier Biomedical offers a full line of freezer storage racks to help make efficient use of space in chest and upright freezers, deep freezers, and ultra-low temperature freezers.

Normally, freezer racks may have horizontal access (for upright freezers) or vertical openings (for chest freezers). For optimal storage, client can choose racks designed to fit the particular freezer model or product.



## Product Features

- Manufactured using advanced capacitor energy storage resistance welding to product solid weld with smooth finish
- Various specifications for different storage requirements-frozen storage tube (box), SBS frozen storage tube (box), centrifugal tube, etc
- Handle is designed to reduce frost and ice build-up around handle
- Customised racking is available for different types of storage containers or models of freezer, contact us for more information

Rack Type	CAT.NO.	Material	Rack Layout (Rows*Columns)	Box Type	Maximum Box Dimensions (mm)	Rack Dimensions (D*W*H)(mm)	Packing Dimensions (D*W*H)(mm)
Sliding-drawer freezer rack	433001	SUS201	5*5	2 inch	133*133*53	686*141*291	730*160*310
	433002	SUS304	5*5	2 inch	133*133*53	686*141*291	730*160*310
	433003	SUS201	5*4	2 inch	133*133*53	552*141*291	590*160*310
	433004	SUS304	5*4	2 inch	133*133*53	552*141*291	590*160*310
	433005	SUS201	5*3	2 inch	133*133*53	417*141*291	460*160*310
	433006	SUS304	5*3	2 inch	133*133*53	417*141*291	460*160*310
	433007	SUS201	4*4	2 inch	133*133*53	552*141*240	590*160*250
	433008	SUS304	4*4	2 inch	133*133*53	552*141*240	590*160*250
	434040	SUS304	4*5	2 inch	133*133*53	686*141*233	720*160*320
	434041	SUS304	3*3	2 inch	133*133*53	421*141*175	455*160*190
	433009	SUS304	3*5	3 inch	133*133*94	686*141*291	730*160*310
433010	SUS304	3*4	3 inch	133*133*94	552*141*291	590*160*310	
433011	SUS304	7*5	For 0.5ml tube	133*133*37	686*141*291	730*160*310	
Side-access freezer rack	434036	SUS304	6*4	2 inch	133*133*53	558*140*320	610*160*335
	433012	SUS304	5*5	2 inch	133*133*53	686*141*291	730*160*310
	433013	SUS304	5*4	2 inch	133*133*53	552*141*291	590*160*310
	433037	SUS304	5*3	2 inch	133*133*53	417*141*291	460*160*310
	433014	SUS304	3*5	3 inch	133*133*94	686*141*291	730*160*310
	433015	SUS304	3*4	3 inch	133*133*94	552*141*291	590*160*310
433016	SUS304	4*4	2 inch	133*133*53	552*141*240	590*160*250	

Rack Type	CAT.NO.	Material	Rack Layout (Rows*Columns)	Box Type	Maximum Box Dimensions (mm)	Rack Dimensions (D*W*H)(mm)	Packing Dimensions (D*W*H)(mm)
SBS freezer rack	433017	SUS304	5*7	For 1.0ml/2ml sbs tube	86*128*50.8	686*141*291	730*160*310
	433018	SUS304	7*7	For 0.5ml sbs tube	86*128*38.5	686*141*291	730*160*310
	433019	SUS304	5*6	For 1.0ml/2ml sbs tube	86*128*50.8	552*141*291	590*160*250
	433020	SUS201	5*7	For 1.0ml/2ml sbs tube	86*128*50.8	686*141*291	730*160*310
	433021	SUS201	7*7	For 0.5ml sbs tube	86*128*38.5	686*141*291	730*160*310
	433022	SUS201	5*6	For 1.0ml/2ml sbs tube	86*128*50.8	552*141*291	590*160*250
Chest-type freezer rack	433023	SUS304	6 layer	2 inch	133*133*53	141*141*332	160*160*350
	433025	SUS304	8 layer	2 inch	133*133*53	141*141*442	160*160*480
	433026	SUS304	10 layer	2 inch	133*133*53	141*141*552	160*160*560
	433028	SUS304	12 layer	2 inch	133*133*53	141*141*662	160*160*680
Centrifugal tube freezer rack	433029	SUS304	5*22*2 layer	15ml centrifuge tube	/	686*141*291	730*160*310
	433030	SUS304	3*16*2 layer	50ml centrifuge tube	/	686*141*291	730*160*310

Haier Biomedical ULT Freezer Model	CAT.NO.	Rack Type	Box Type	Rack Layout (Rows*Columns)	Freezer Rack Quantity	Freezer Box Quantity	Cryo Tube Quantity (2ml)
DW-86L338J/ DW-86L338JA	433013 (middle, 2 layers)	Side-access freezer rack	2 inch	5*4	6	120	12000
	433003/433004 (middle, 2 layers)	Sliding-drawer freezer rack	2 inch	5*4	6	120	12000
	433016 (top and bottom layers)	Side-access freezer rack	2 inch	4*4	6	96	9600
	433007/433008 (top and bottom layers)	Sliding-drawer freezer rack	2 inch	4*4	6	96	9600
DW-86L388J/ 418S/418ST/419	433012	Side-access freezer rack	2 inch	5*5	12	300	30000
	433001/433002	Sliding-drawer freezer rack	2 inch	5*5	12	300	30000
DW-86L486E	433013	Side-access freezer rack	2 inch	5*4	16	320	32000
	433003/433004	Sliding-drawer freezer rack	2 inch	5*4	16	320	32000
DW-86L490J/490JA	433013 (top 2 layers)	Side-access freezer rack	2 inch	5*4	8	160	16000
	433003/433004 (top 2 layers)	Sliding-drawer freezer rack	2 inch	5*4	8	160	16000
	433016 (bottom 2 layers)	Side-access freezer rack	2 inch	4*4	8	128	12800
	433007/433008 (bottom 2 layers)	Sliding-drawer freezer rack	2 inch	4*4	8	128	12800
DW-86L628E	433013	Side-access freezer rack	2 inch	5*4	20	400	40000
	433003/433004	Sliding-drawer freezer rack	2 inch	5*4	20	400	40000
DW-86L578J/578JA/ 578S/578ST/579/579BP/ 579BPT/578BPST	433012	Side-access freezer rack	2 inch	5*5	16	400	40000
	433001/433002	Sliding-drawer freezer rack	2 inch	5*5	16	400	40000
DW-86L728J/728JA/ 728S/728ST/728SAT/729/ 729BP/729BPT/728BPST	433012	Side-access freezer rack	2 inch	5*5	20	500	50000
	433001/433002	Sliding-drawer freezer rack	2 inch	5*5	20	500	50000
DW-86L828J/828JA/ 828S/828ST/829/829BP/ 829BPT/828W/828BPST	433012	Side-access freezer rack	2 inch	5*5	24	600	60000
	433001/433002	Sliding-drawer freezer rack	2 inch	5*5	24	600	60000
DW-86L959BP/ 959BPT/959W	433012	Side-access freezer rack	2 inch	5*5	28	700	70000
	433001/433002	Sliding-drawer freezer rack	2 inch	5*5	28	700	70000
DW-86L100J	433005/433006	Sliding-drawer freezer rack	2 inch	5*3	4	60	6000
DW-86W420J/420JA	433026	Chest-type freezer rack	2 inch	10 layer	27	270	27000
DW-86W100J	433025	Chest-type freezer rack	2 inch	8 layer	9	72	7200
DW-150W200	433026	Chest-type freezer rack	2 inch	10 layer	12	120	12000
DW-150W209/ 150W209A	433026	Chest-type freezer rack	2 inch	10 layer	12	120	12000
	433028	Chest-type freezer rack	2 inch	12 layer	12	144	14400
DW-86L51J	433005/433006	Sliding-drawer freezer rack	2 inch	5*3	2	30	3000

## Barcode Cryogenic Tubes and Storage Boxes

Haier Biomedical can provide a range of high quality cryogenic storage tubes, which can withstand the extremes of cryogenic conditions while protecting the valuable samples. Meanwhile the Haier Biomedical cryogenic storage tubes have high compatibility with above freezer storage racks and ULT freezers, meeting the client's one-stop demands.



## Product Features

- Rigorous cytotoxicology-testing ensures pyrogen, RNase, DNase and endotoxins levels are less than 0.005EU/mL
- Complying with ANSI/SLAS international standards, suitable for a variety of automated storage and processing equipment
- Laser etching process and three-code information integration technology are adopted to ensure the security and redundancy to provide an extra layer of protection
- The snap design of the base is easy to use and prevents scratches after freezing
- Designed and manufactured to prevent leakage at -98kpa to meet the IATA dangerous goods PI650 standard

CAT.NO.	Description	Unit Quantity	Packing Specification
413001	0.5ml (ultra-low temperature volume 0.5ml), slender, external spin tube, bottom prefabricated QR code, side wall prefabricated digital code and 1D barcode; box side prefabricated digital code and 1D barcode, box bottom prefabricated QR code, 8*12 standard SBS layout	7680	96pcs/box, 80boxes/case
413002	0.75ml (ultra-low temperature volume 0.75ml), slender, external spin tube, bottom prefabricated QR code, side wall prefabricated digital code and 1D barcode; box side prefabricated digital code and 1D barcode, box bottom prefabricated QR code, 8*12 standard SBS layout	6720	96pcs/box, 70boxes/case
413003	1.0ml (ultra-low temperature volume 1.0ml), slender, external spin tube, bottom prefabricated QR code, side wall prefabricated digital code and 1D barcode; box side prefabricated digital code and 1D barcode, box bottom prefabricated QR code, 8*12 standard SBS layout	4800	96pcs/box, 50boxes/case
413004	2.0ml (ultra-low temperature volume 1.9ml), slender, external spin tube, bottom prefabricated QR code, side wall prefabricated digital code and 1D barcode; box side prefabricated digital code and 1D barcode, box bottom prefabricated QR code, 6*8 standard SBS layout	2400	48pcs/box, 50boxes/case
413005	2.0ml (ultra-low temperature volume 1.9ml), slender, external spin tube, bottom prefabricated QR code, side wall prefabricated digital code and 1D barcode; box side prefabricated digital code and 1D barcode, box bottom prefabricated QR code, 10*10 square layout	3000	100pcs/box, 30boxes/case
413006	0.5ml (ultra-low temperature volume 0.5ml), slender, external spin tube, bottom prefabricated QR code, side wall prefabricated digital code and 1D barcode	13200	220pcs/bag, 60bags/box
413007	1.0ml (ultra-low temperature volume 1.0ml), slender, external spin tube, bottom prefabricated QR code, side wall prefabricated digital code and 1D barcode	6000	150pcs/bag, 40bags/case
413008	2.0ml (ultra-low temperature volume 1.9ml), slender, external spin tube, bottom prefabricated QR code, side wall prefabricated digital code and 1D barcode	3500	70ticks/bag, 50bags/box
413009	Cryopreservation box, matching 0.5ml slender external rotation cryopreservation tube, prefabricated digital code and 1D barcode on the side of the box, prefabricated QR code at the bottom of the box, 8*12 standard SBS layout	80	80boxes/case
413010	Cryopreservation box, matching 0.75ml slender external rotation cryopreservation tube, prefabricated digital code and 1D barcode on the side of the box, prefabricated QR code at the bottom of the box, 8*12 standard SBS layout	70	70boxes/case
413011	Cryopreservation box, matching 1.0ml slender external rotation cryopreservation tube, prefabricated digital code and 1D barcode on the side of the box, prefabricated QR code at the bottom of the box, 8*12 standard SBS layout	50	50boxes/case
413012	Cryopreservation box, matching 2.0ml slender external rotation cryopreservation tube, prefabricated digital code and 1D barcode on the side of the box, prefabricated QR code at the bottom of the box, 6*8 standard SBS layout	50	50boxes/case
413013	Cryopreservation box, matching 2.0ml slender external rotation cryopreservation tube, prefabricated digital code and 1D barcode on the side of the box, prefabricated QR code at the bottom of the box, 10*10 standard SBS layout	30	30boxes/case

## Universal Cryogenic Tubes and Storage Boxes

69/70

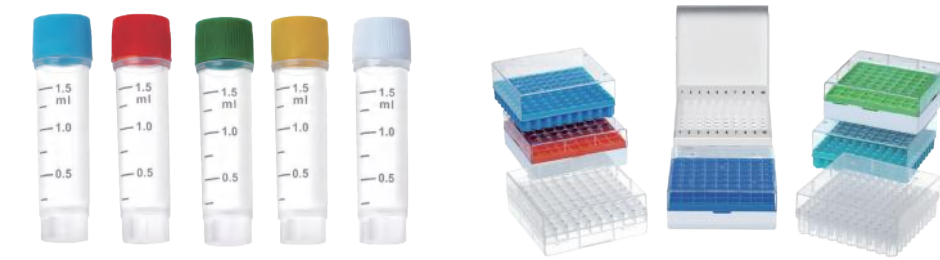

## Product Features

- Detachable color label design, color classification of samples according to requirements
- Clear scale and large writing area
- Internal rotation and external rotation are designed to meet different sample storage requirements
- Multi-color tube cap design, according to the needs of the sample color classification
- 2D tube bottom prefabricated two-dimensional code, laser etching technology, wear and corrosion resistant
- Pipe wall prefabricated bar code and digital code, three codes in one, to meet different scene identification

CAT.NO.	Description	Unit Quantity	Packing Specification
423001	Paper freezer box, 2 inches 81 compartments, white, flip lid	50	50boxes/case
423002	Paper freezer box, 2 inches 100 compartments, white, flip lid	50	50boxes/case
421003	81-well PP freezer box, -121-90°C, monochrome box, white, yellow, red, blue, green optional, flat lid	50	50boxes/case
421004	100-well PP freezer box, -121-90°C, monochrome box, white, yellow, red, blue, green optional, flat lid	50	50boxes/case
422005	25-well PC freezer box, -196-121°C, monochrome box, purple, red, blue, green optional, flat lid	50	50boxes/case
422006	81-well PC freezer box, -196-121°C, monochrome box, purple, red, blue, green optional, flat lid	50	50boxes/case
422007	100-well PC freezer box, -196-121°C, monochrome box, purple, red, blue, green optional, flat lid	50	50boxes/case
422010	3-inch 81-well PC freeze storage box, -196-121°C, single color one box, white, red, blue, green optional, flat lid	20	20boxes/case
422008	Supporting 0.5ml external rotation cryopreservation tube, 100-well PC cryopreservation box, -196-121°C, blue (supporting H-ES05B; H-ES05D-TS)	50	50boxes/case
422009	Supporting 1.5ml external rotation cryopreservation tube, 100-well PC cryopreservation box, -196-121°C, blue (supporting H-ES15B; H-ES15D-TS)	50	50boxes/case
423010	0.5ml cryopreservation tube, external rotation, self-standing bottom, with scale, with white writing area, -196°C - 121°C	1000	100pcs/bag, 10bags/case
423011	1.5ml cryopreservation tube, external rotation, self-supporting bottom, with scale, with white writing area, -196°C - 121°C	1000	100pcs/bag, 10bags/case
423012	2ml cryopreservation tube, external rotation, self-supporting bottom, with O-ring, with scale, with white writing area, -196°C - 121°C	1000	100pcs/bag, 10bags/case
423013	5ml cryopreservation tube, external rotation, self-supporting bottom, with O-ring, with scale, with white writing area, -196°C - 121°C	1000	100pcs/bag, 10bags/case
423014	1ml cryopreservation tube, internal rotation, self-supporting bottom, with O-ring, with scale, with white writing area, -196°C - 121°C	1000	100pcs/bag, 10bags/case
423015	2ml cryopreservation tube, internal rotation, self-supporting bottom, with O-ring, with scale, with white writing area, -196°C - 121°C	1000	100pcs/bag, 10bags/case
423016	0.5ml cryopreservation tube (boxed), external rotation, self-supporting bottom, with scale, with white writing area, -196°C - 121°C	1200	100pcs/box, 12boxes/case
423017	1.5ml cryopreservation tube (boxed), external rotation, self-supporting bottom, with scale, with white writing area, -196°C - 121°C	1200	100pcs/box, 12boxes/case
423018	0.5ml 2D cryopreservation tube (bagged), external rotation, self-supporting bottom, with scale, bottom QR code, side barcode + digital code, -196°C-121°C	1000	100pcs/bag, 10bags/case
423019	1.5ml 2D cryopreservation tube (bagged), external rotation, self-supporting bottom, with scale, bottom QR code, side barcode + digital code, -196°C-121°C	1000	100pcs/bag, 10bags/case
423020	0.5ml 2D cryopreservation tube (boxed), external rotation, self-supporting bottom, with scale, bottom QR code, side barcode + digital code, -196°C-121°C	1200	100pcs/box, 12boxes/case
423021	1.5ml 2D cryopreservation tube (boxed), external rotation, self-supporting bottom, with scale, bottom QR code, side barcode + digital code, -196°C-121°C	1200	100pcs/box, 12boxes/case

# High Speed Batch Scanner

The Haier high speed batch scanner can be used to scan various coded, boxed prefabricated code cryogenic tubes to achieve high-speed identification and efficient management of samples.



Detachable module design, compatible with SBS, square and other cryogenic boxes

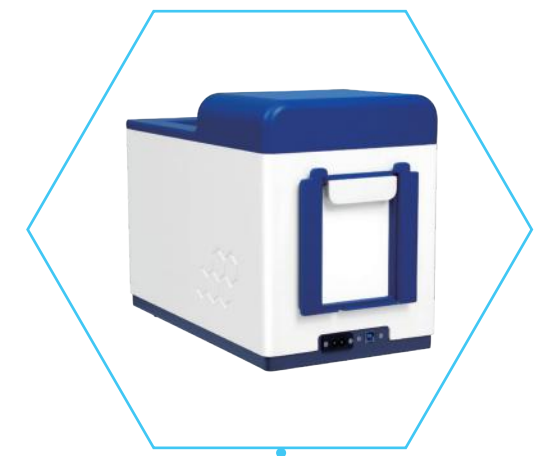

Ergonomic design: The scanner can be wall-mounted and stored safely using the attachment included

Intelligent induction of tube boxes and automatic light filling function, adaptable to multiple applications

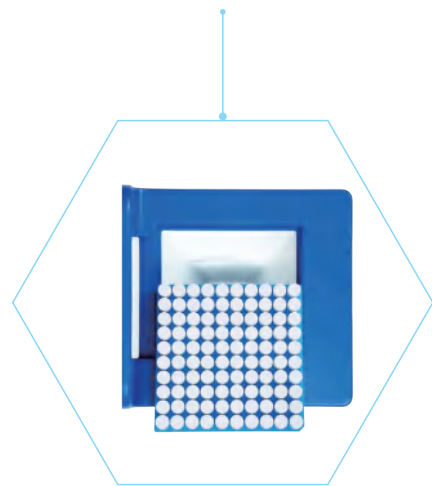

Reading synchronously the bottom code of freezing tubes and of boxes

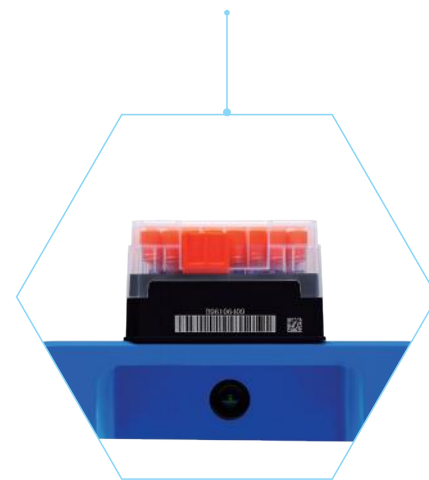

Classification	Model	Parameter	Sets/Case	Package
High speed batch scanner	HS-SBS-001	Batch scanning, high-speed scanning, side code scanning, suitable for 10*10 /SBS and other specifications of prefabricated coded standard cryogenic tube/box of various brands	1	1 set/case
	HS-SBS-002	Batch scanning, high-speed scanning, side code scanning, suitable for 10*10 /SBS and other specifications of prefabricated coded standard cryogenic tube/box of various brands	1	1 set/case
Top batch scanner	HS-100-002	Batch scanning, high-speed scanning, top scanning, suitable for scanning of 10*10/9*9 cryogenic tube, centrifuge tube, etc. (two-dimensional code label is pasted on the top)	1	1 set/case



The Hoierh single tube scanner is flexible and quick to scan information



Wireless communication distance up to 30 meters



Support battery charging and replacement, can work for 20 hours or standby for 50 hours when fully charged



Excellent DPM code reading ability, suitable for all kinds of precision code recognition, fast and accurate

Classification	Model	Parameter	Sets/case	package
Single tube scanner	HS-H-001	Handheld scanner, provide single cryogenic tube or cryogenic box, scanner recognition one-dimensional code/two-dimensional code function, plug and play	1	1 set/case
	HS-W-001	Wireless handheld scanner, provide single cryogenic tube or cryogenic box, scanner recognition one-dimensional code/two-dimensional code function, plug and play	1	1 set/case
	HS-T-001	Desktop scanner, provide single cryogenic tube or cryogenic box, scanner recognition one-dimensional code/two-dimensional code function, plug and play	1	1 set/case

The Hoierh batch cover opener opens or closes the multi-channel cap which provides increased efficiency compared to manual operation and reduces the risk of contact with biochemical reagents and other safety risks



Simultaneously open up to 8 channels at one time



Convenient and fast removal of cover



Support design, convenient storage opened batch tube cover

Classification	Model	Parameter	Sets/case	package
Batch cover opener	BQ-OP8	The 8-channel hand-held electric cover opener can open the prefabricated QR code cryogenic tube (8x12) with 8 cryogenic tube covers in a row, or (diamond layout 8x6) with 4 cryogenic tube covers in a row	1	1 set/case
	BQ-OP4	The 4-channel hand-held electric cover opener can open the prefabricated QR code cryogenic tube (4x12) with 4 cryogenic tube covers in a row, or (4x6) with 4 cryogenic tube covers in a row	1	1 set/case

# Low Temperature Label Printer

The low-temperature printer allows users to print different labels that are durable, stable, and resistant to wear, ensuring the long-term safety of sample information.



Suitable for all kinds of experimental instruments, resistant to solvent and chemical corrosion, repeated freezing and thawing without falling off

Touch operation for quick adjustment of printer Settings



High performance printing, meet the high requirements of biobank processing

Classification	Product Number	Model	Supporting Printer	Parameter	Loading Capacity
Printer	i5100 300dpi	Printer i5100 300dpi	\	Thermal transfer printer, printing accuracy 300dpi, maximum printing speed 300mm/s	1 set/case
	BBP12	Brady BBP12 printer	\	Printing accuracy 300dpi, low-end printing	1 set/case
	i5100 600dpi	Printer i5100 600dpi	\	Thermal transfer printer, printing accuracy 600dpi, maximum printing speed 150mm/s	1 set/case
Ribbon	IP-R4302	Ribbon IP R4302	i5100 300dpi	60mm*300m/roll, used together with IP 300; Print about 4-5 rolls of labels (B490A or B490B)	1 roll/bag
	IP-R4902	Ribbon IP-R4902	i5100 300dpi	60mm*300m/roll, used together with IP 300; Print about 4-5 rolls of labels (B6422)	1 roll/bag
	R4313	Ribbon R4313	BBP11/BBP12	110mm*74m/roll, used with BBP11/BBP12 printer	1 roll/bag
Label	THT-152-053-3-2A	B053 material (25.4*9.53mm)*2 two rows of labels	i5100 300dpi	Label for room temperature use. The label material is synthetic paper, and the use temperature range is -20°C-+80°C; Two labels in a row, 3000 pcs/roll, and the matching ribbon is IP-R4302	3000 pcs/roll
	THT-152-053-3-RP	B053 material 25.4*9.53mm one in a row	i5100 300dpi	Label for normal temperature use. The label material is synthetic paper, and the use temperature range is -20°C-+80°C; Two labels in a row, 4000 pcs/roll, and the matching ribbon is IP-R4302; Customized, pre printed coding	4000 pcs/roll
	THT-163-6422-3	B6422 lable 25.4mm*9.53mm + D=9.53mm	i5100 300dpi	Apply to cryogenic tube below 2ml; Environment temperature above 40 °C	3000 pcs/roll
	THT-163-490-3	B490 material 25.4mm*9.53mm + D=9.53mm	i5100 300dpi	Apply to cryogenic tube below 2ml and pasted on the wall and round cover of the cryogenic tube; Can withstand can be directly pasted after taking out the cryogenic tube in liquid nitrogen at room temperature	3000 pcs/roll
	THT-152-490-3	B490 material 25.4mm*9.53mm	i5100 300dpi	Apply to cryogenic tube below 2ml, only pasted on the wall of cryogenic tube; Can withstand can be directly pasted after taking out the cryogenic tube in liquid nitrogen at room temperature	3000 pcs/roll
	THT-151-490-3	B490 material 15.24mm*10.16mm+D=8.26mm	i5100 300dpi	Apply to cryogenic tube below 2ml and pasted on the wall and round cover of the cryogenic tube; Can withstand can be directly pasted after taking out the cryogenic tube in liquid nitrogen at room temperature	3000 pcs/roll

# Biomedical Freezer





# -60°C Biomedical Freezer

A versatile low-temperature freezer installed in hospitals, blood stations, diseases control & prevention centers, research institutions, bioscience laboratories and medical laboratories. It is suitable for storing a wide variety of biological products including viruses, bacteria, red blood cells, white blood cells, skin, bone and semen as well as ocean-going supplies and electronic devices. It can also provide a low-temperature environment for testing of special materials.

The secondary application is for the storage of fishery products such as tuna, Australian lobster, salmon, South American shrimps, Argentina red shrimp, top-quality beef, kanpachi, octopus, yellowtail, bonito fish, grouper, and fugu rubripes. This is a requirement for fishery products for human consumption and hence these freezers are popular among professional oceanic fisherman, seafood distributors, speciality seafood stores and sushi restaurants and commercial food manufacturers.



DW-60W258



German Made Energy Efficient Compressor



Digital Temperature Control display



Dual-seal Design



Efficient and Reliable Fan

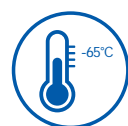

Quickly freeze sea food products to retain their original taste, structure and freshness.



Low noise output, noise cancelling technology yields a smoother operation and a sound level of less than 43dB(A).



Multiple alarm system includes temperature alarm, and sensor error alarm.



HC refrigerant system is optimized to improve refrigeration efficiency by 30%, and save energy by about 50%.

Single compressor auto cascade refrigeration system provides high efficient cooling power. 100m Insulation ensure optimal thermal protection and energy efficiency.



Dual seal design retains cold and reduces condensation.



304 stainless steel is suitable for both laboratory and is certified food safe for commercial kitchen environments.



Key lock product protection and lockable casters for ease of moving and safe installation.



An easy to use, waterproof digital controller

## Temperature Curve

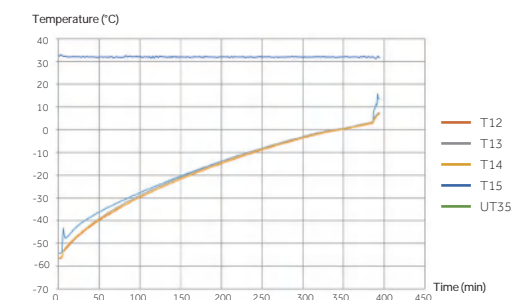
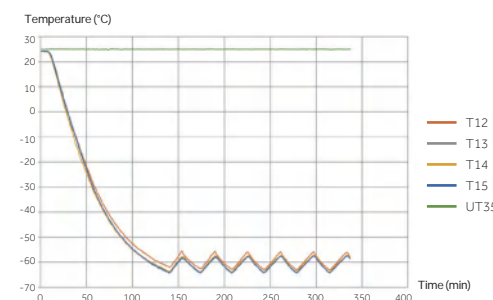

## Specifications

Model		DW-60W138	DW-60W258	DW-60W388	
Technical Data	Cabinet Type	Chest	Chest	Chest	
	Climate Class	N	N	N	
	Cooling Type	Direct Cooling	Direct Cooling	Direct Cooling	
	Refrigerant	HC	HC	HC	
	Sound Level ((dB(A))	43	43	43	
Performance	Cooling Performance (°C)	-60	-60	-60	
	Temperature Range (°C)	-30--60	-30--60	-30--60	
Control	Controller	Microprocessor	Microprocessor	Microprocessor	
	Display	LED	LED	LED	
Electrical Data	Power Supply (V/Hz)	220-240/50	220-240/50	220-240/50	
	Power (W)	370	410	420	
	Electrical Current (A)	3	3	3.5	
	Power Consumption (kWh/24h)	4.5	5.5	6.5	
Construction	Capacity (L/Cu.Ft)	138/4.9	258/9.1	388/13.7	
	Net/Gross Weight (approx)	kg	62/75	88/108	105/130
		lbs	137/165	194/238	232/287
	Interior Dimensions (W*D*H)	mm	580*445*620	1000*445*620	1450*445*620
		in	22.8*17.5*24.4	39.4*17.5*24.4	57.1*17.5*24.4
	Exterior Dimensions (W*D*H)	mm	790*770*950	1210*770*950	1655*770*950
		in	31.1*30.3*37.4	47.6*30.3*37.4	65.2*30.3*37.4
Packing Dimensions (W*D*H)	mm	815*800*990	1255*800*990	1695*800*990	
	in	32.1*31.5*39	49.4*31.5*39	66.7*31.5*39	
Loading Quantities	Container Load (20'/40'/40'H)	28/56/56	22/46/46	14/28/28	
Alarms	High/Low Temp	Y	Y	Y	
	Sensor Error	Y	Y	Y	
Accessories	Caster	Y	Y	Y	
	Porthole	Y	Y	Y	
Certification	CE	Y	Y	Y	

Product appearance and specifications are subject to change without notice

## -40°C Biomedical Freezer (Chest)

This product is designed to store vaccines, blood plasma and many other biological materials. Suitable for scientific research institutes, blood stations, hospitals, centers for disease control and prevention, and material science, electronics and chemical laboratories.



DW-40W138J/255J/380J

### Scope of Application:



#### Temperature Control

- Microcomputer control, digital temperature display, display precision is 0.1°C. Adjustable temperature set point -20°C--40°C
- User settable temperature alarms



#### Safety System

- Multiple alarms: high/low temperature alarm/sensor error alarm/power failure alarm. Optional high ambient warning and remote alarm contacts
- Battery backed-up alarm will alert for more than 24 hours in case of power failure
- Equipped with overcurrent protector for safety



#### Refrigeration System

- Durable, market-leading brand compressors and EBM condensing fan ensure a high refrigeration efficiency and maximizes temperature performance
- High density insulation layer delivers superior insulation performance
- Evaporator and condenser design delivers excellent refrigeration efficiencies
- Non-toxic, environmentally-friendly hydrocarbon refrigerants

### Temperature Curve

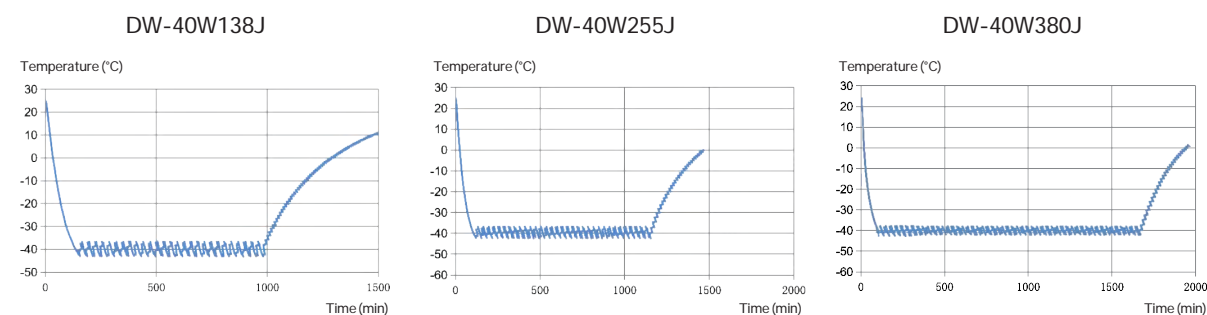

### Specifications

Model	DW-40W138J	DW-40W255J	DW-40W380J		
Technical Data	Cabinet Type	Chest	Chest	Chest	
	Climate Class	SN N	SN N	SN N	
	Cooling Type	Direct Cooling	Direct Cooling	Direct Cooling	
	Defrost Mode	Manual	Manual	Manual	
	Refrigerant	HC	HC	HC	
	Sound Level (dB(A))	42	42	42	
Performance	Cooling Performance (°C)	-40	-40	-40	
	Temperature Range (°C)	-20--40	-20--40	-20--40	
Control	Controller	Microprocessor	Microprocessor	Microprocessor	
	Display	LCD	LCD	LCD	
Electrical Data	Power Supply (V/Hz)	220~240/50	220~240/50	220~240/50	
	Power (W)	260	370	450	
	Electrical Current (A)	2.3	3.1	2.9	
Dimensions	Capacity (L/Cu.Ft)	138/3.9	255/9.0	380/13.4	
	Net/Gross Weight (approx)	kg	52/65	76/96	90/115
		lbs	114.6/143.3	167.5/211.6	198.4/253.5
	Interior Dimensions (W*D*H)	mm	580*445*620	1000*445*620	1450*445*620
		in	22.8*17.5*24.4	39.4*17.5*24.4	57.1*17.5*24.4
	Exterior Dimensions (W*D*H)	mm	790*770*950	1210*770*950	1655*770*950
		in	31.1*30.3*37.4	47.6*30.3*37.4	65.2*30.3*37.4
Packing Dimensions (W*D*H)	mm	840*810*1000	1260*810*1000	1710*815*990	
	in	33.1*31.9*39.4	49.6*31.9*39.4	67.3*32.1*39.0	
Container Load (20/40/40'H)	28/56/56	16/36/54	12/28/28		
Alarms	High/Low Temperature	Y	Y	Y	
	Remote Alarm	Optional	Optional	Optional	
	Power Failure	Y	Y	Y	
	Sensor Error	Y	Y	Y	
	High Ambient Temperature	Optional	Optional	Optional	
Accessories	Caster	Y	Y	Y	
	Porthole	Y	Y	Y	
	USB Interface/RS485	Optional (USB or RS485, either-or)	Optional (USB or RS485, either-or)	Optional (USB or RS485, either-or)	
Others	Certificate	CE	CE	CE	

\*Haier Biomedical reserves the right to change products and specifications without prior notice.

# -40°C Biomedical Freezer (Upright)

## Key Features

- Microprocessor control, adjustable temperature range :-20°C to -40°C
- LED digital display and increment at 0.1°C
- Permanently lubricated cooling fan for safety and longevity
- Rapid cooling with shelf evaporator
- Removable double outer door seal design

## Ergonomic Design

- USB data logging and temperature recorder (optional)
- Padlock for safe storage
- Drawers are designed with label holders for item identification

## Safety

- Multiple alarms include high/low temperature, sensor error, power failure, high ambient temperature, low battery, door ajar
- Alarm Types: buzzer, flashing light, remote alarm



Reliable Performance



USB



Alarms



Double Outer Door Seal



DW-40L278



Padlock



Caster and Feet



Removable Double Outer Door Seal

## Temperature Curve

DW-40L278

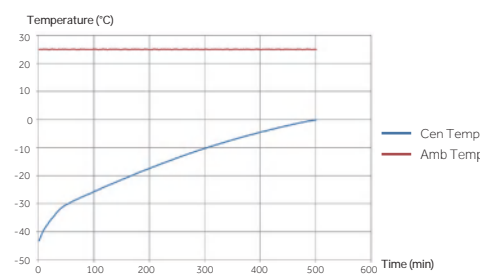
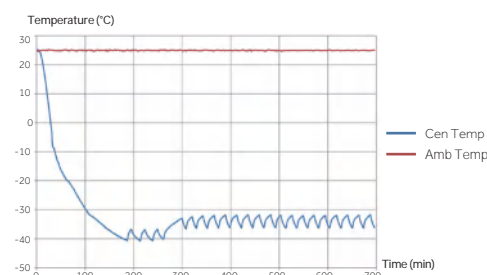
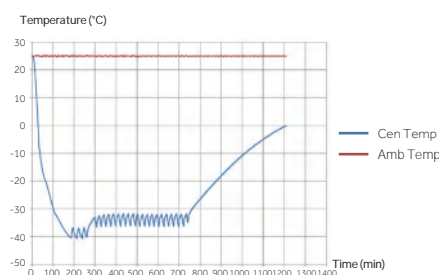

Suitable for the storage of plasma, biological material, reagents and other essential items. Used within hospitals, disease prevention, academia and commercial laboratories.



DW-40L298J

## Scope of Application:



### HC Energy-saving

High efficiency hydrocarbon compressor and refrigeration technology for a lower energy consumption



### Superior Uniformity

With the optimized system design, the temperature uniformity of the characteristic point is  $\pm 3^{\circ}\text{C}$ , and the uniformity of the whole temperature zone is controlled within  $\pm 5^{\circ}\text{C}$



### Environmental Protection

Hydrocarbon refrigerant, LBA foam polyurethane insulation layer



### Adjustable Shelves

Built-in evaporator and adjustable shelves provides large available interior space. Users can store items of different sizes as needed

## Temperature Curve

DW-40L298J Typical Performance Characteristics at 25°C Ambient

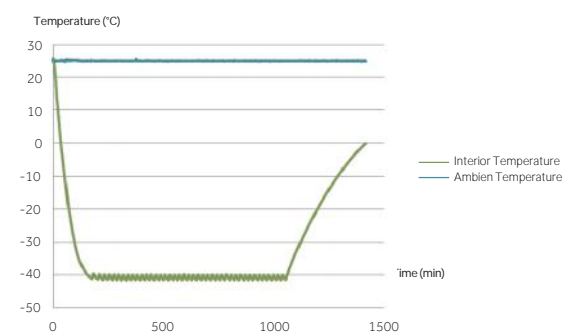



**-40°C Biomedical Freezer (Upright)****Specifications**

Model	DW-40L92		DW-40L262		DW-40L278		DW-40L298J	DW-40L568J	
Technical Data	Cabinet Type	Upright		Upright		Upright		Upright	
	Climate Class	SN N		SN N		SN N		SN N	
	Cooling Type	Direct Cooling		Direct Cooling		Direct Cooling		Direct Cooling	
	Defrost Mode	Manual		Manual		Manual		Manual	
	Refrigerant	HC		HC	CFC-Free	HC	CFC-Free	HC	
	Sound Level (dB(A))	29		41	44	40	44	39.2	45
Performance	Cooling Performance (°C)	-40		-40		-40		-40	
	Temperature Range (°C)	-20~-40		-20~-40		-20~-40		-20~-40	
Control	Controller	Microprocessor		Microprocessor		Microprocessor		Microprocessor	
	Display	LCD		LCD		LCD		LED	
Electrical Data	Power Supply (V/Hz)	220-240/50/60		220-240/50/60	115/60	220-240/50	220-240/50/60	220-240/50	
	Power (W)	340		310	600	275	370	570	
	Electrical Current (A)	2.2		2	7.5	2.9	5.1	4.1	
	Power Consumption (kWh/24h)	1.4		2.6	4.3	3.1	5.3	/	
Construction	Capacity (L/Cu.Ft)	92/3.2		262/9.3		278/98		298/10.5	
	Net/Gross Weight (approx)	kg	46/51		88/93		115/135		125/140
		lbs	101.4/112.4		194.0/205.0		253.5/297.6		275.6/308.6
	Interior Dimensions (W*D*H)	mm	435*410*635		480*465*1430		520*435*1230		541*443*1218
		in	17.1*16.1*25.0		18.9*18.3*56.3		20.5*17.1*48.4		21.3*17.4*48.0
	Exterior Dimensions (W*D*H)	mm	640*610*810		700*705*1665		770*710*1810		770*710*1828
		in	25.2*24.0*31.9		27.6*27.8*65.6		30.3*28.0*71.3		30.3*28.0*72.0
	Packing Dimensions (W*D*H)	mm	660*700*910		775*760*1880		840*770*2000		840*770*2000
in		26.0*27.6*35.8		30.5*29.9*74.0		33.0*30.3*78.7		33.0*30.3*78.7	
Loading Quantities	Container Load (20'/40'/40'H)	48/108/108		21/45/45		21/42/42		21/42/42	
Alarms	High/Low Temperature	Y		Y		Y		Y	
	Remote Alarm	Y		Y		Y		Y	
	Power Failure	Y		Y		Y		Y	
	Sensor Error	Y		Y		Y		Y	
	Low Battery	/		/		Y		Y	
	High Ambient Temperature	Y		Y		Y		Y	
	Door Ajar	Y		Y		Y		Y	
Accessories	Caster	Y		Y		Y		Y	
	Foot	Y		Y		Y		Y	
	Porthole	Y		Y		Y		Y	
	Drawers/Inner Doors	3/-		7/-		6/-		Optional/2	
	USB Interface	Optional		Optional	/	Optional		Optional	
	RS485	Optional		Optional		Optional		Optional	
Temperature Recorder	/		/		Optional		Optional		
Certification	CE	Y		Y	/	Y		Y	

\*Haier Biomedical reserves the right to change products and specifications without prior notice.

## -40°C Biomedical Freezer (Double Doors Type)

The double door -40°C biomedical freezer models offer a large capacity storage space with rapid cooling. Integrated design of cold shelf and evaporator provides additional refrigeration efficiency. Designed to store vaccines, blood plasma and many other biological materials. Installations can be found in research institutions and clinical sites in the life science, pharma, biotech, medical and electronics sectors.



DW-40L508

DW-40L348



Control Panel



Drawer



Shelf

## -40°C Biomedical Freezer (Double Doors Type)

The DW-40L348 is based on the original workhorse platform of DW-40L508. The new freezer model operates with two capillary tubes and is equipped with dual gaskets to improve the temperature uniformity through the chamber drastically. It can be installed to satisfy tougher application requirements in universities, research institutions and blood banks.

### Reliability and Key Features

- Rated for -40°C at 32°C ambient
- Rapid cooling with shelf evaporator
- Improved temperature uniformity with dual capillary tube design at the range of -20°C to -40°C
- Improved door seal design with two gaskets maintains cabinet temperature more efficiently
- Reduced frost buildup
- 90mm insulation thickness for additional robustness, less power consumption and better temperature-retaining ability
- Drawer design maximizes storage space. One unit can hold 360 bags of 230 ml blood bags
- Optional USB interface

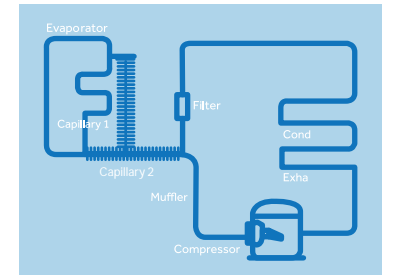

### Safety

- Multiple alarms include high/low temperature, power failure, sensor error, low battery, high ambient temperature
- Two types of alarms: buzzer and flashing light, remote alarm



### Ergonomic Design

- LED digital display
- Double door design with independent locks to ensure temperature stability and lower power consumption
- Label holders for product identification



### Temperature Curve

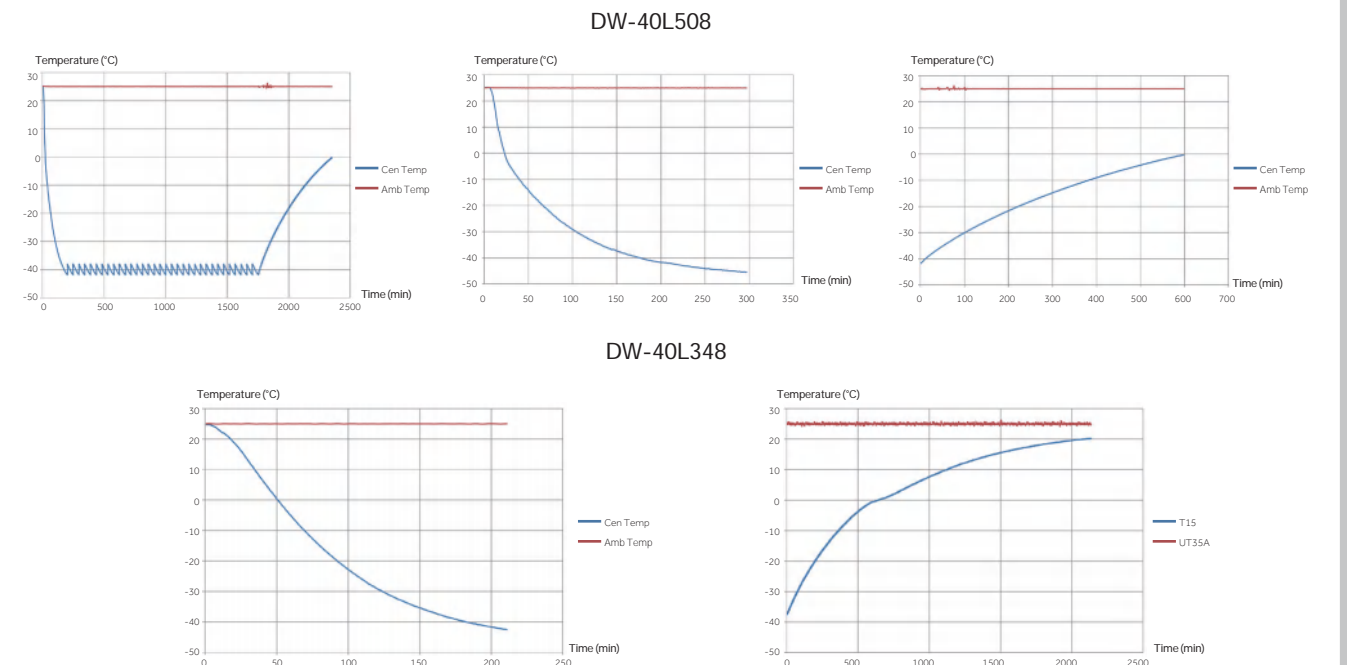

## -40°C Biomedical Freezer (Double Doors Type)

Suitable for the storage of plasma, biological material, reagents and other essential items. Used within hospitals, disease prevention, academia and commercial laboratories.



DW-40L418D/528D

### Scope of Application:



#### HC Energy-saving

High efficiency hydrocarbon compressor and refrigeration technology for a lower energy consumption



#### Superior Uniformity

With the optimized system design, the temperature uniformity of the characteristic point is  $\pm 3^{\circ}\text{C}$ , and the uniformity of the whole temperature zone is controlled within  $\pm 5^{\circ}\text{C}$



#### Environmental Protection

Hydrocarbon refrigerant, LBA foam polyurethane insulation layer



#### Adjustable Shelves

Built-in evaporator and adjustable shelves provides large available interior space. Users can store items of different sizes as needed

### Temperature Curve

DW-40L418D Typical Performance Characteristics at 25°C Ambient

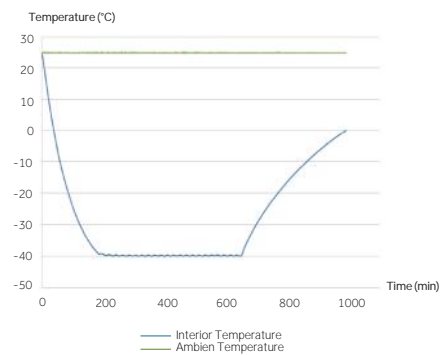

DW-40L528D Typical Performance Characteristics at 25°C Ambient

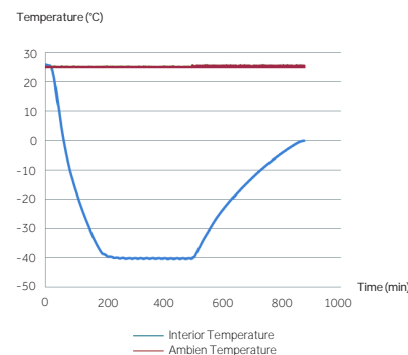

### Specifications

Model	DW-40L348	DW-40L508	DW-40L418D	DW-40L528D		
Technical Data	Cabinet Type	Upright, Double Door	Upright, Double Door	Upright	Upright	
	Climate Class	SN N	SN N	SN N	SN N	
	Cooling Type	Direct Cooling	Direct Cooling	Direct Cooling	Direct Cooling	
	Defrost Mode	Manual	Manual	Manual	Manual	
	Refrigerant	HC	HC	CFC-Free	HC	
	Sound Level (dB(A))	41	41	45	41.7	45
Performance	Cooling Performance (°C)	-40	-40	-40	-40	
	Temperature Range (°C)	-20--40	-20--40	-20--40	-20--40	
Control	Controller	Microprocessor	Microprocessor	Microprocessor	Microprocessor	
	Display	LED	LED	LED	LED	
Electrical Data	Power Supply (V/Hz)	220-240/50	220-240/50	208-230/60	220-240/50	220-240/50
	Power (W)	280	285	510	640	630
	Electrical Current (A)	2.9	2.9	5.6	4.2	5.7
	Power Consumption (kWh/24h)	3.3	3.8	6.6	/	/
Construction	Capacity (L/Cu.Ft)	348/12.3	490/17.3	418/14.8	531/18.8	
	Net/Gross Weight (approx)	kg	137/145	164/200	145/165	180/205
		lbs	302.0/320.0	361.6/440.9	319.7/363.8	396.8/451.9
	Interior Dimensions (W*D*H)	mm	535*610*1228	685*610*1228	554*620*1230	704*620*1230
		in	21.1*24.0*48.3	27.0*24.0*48.3	21.8*24.4*48.4	27.7*24.4*48.4
	Exterior Dimensions (W*D*H)	mm	790*845*1860	940*845*1860	790*845*1878	940*845*1878
		in	31.1*33.3*73.2	37.0*33.3*73.2	31.1*33.3*73.9	37.0*33.3*73.9
	Packing Dimensions (W*D*H)	mm	852*927*2044	997*927*2044	860*930*2040	1005*940*2040
in		33.5*36.5*80.5	39.3*36.5*80.5	33.9*36.6*80.3	39.6*37.0*80.3	
Loading Quantities	Container Load (20'/40'/40'H)	12/28/28	12/24/24	12/24/26	10/22/24	
Alarms	High/Low Temperature	Y	Y	Y	Y	
	Remote Alarm	Y	Y	Y	Y	
	Power Failure	Y	Y	Y	Y	
	Sensor Error	Y	Y	Y	Y	
	Low Battery	Y	Y	Y	Y	
	High Ambient Temperature	Y	Y	Y	Y	
	Door Ajar	/	/	Y	Y	
	Caster	Y	Y	Y	Y	
Accessories	Foot	Y	Y	Y	Y	
	Porthole	Y	Y	Y	Y	
	Drawers/Inner Doors	12/-	10/-	Optional/-	Optional/-	
	USB Interface	Optional	Optional	Optional	Optional	
	RS485	Optional	Optional	Optional	Optional	
	Temperature Recorder	Optional	Optional	Optional	Optional	
Certification	CE	Y	Y	Y	Y	

\*Haier Biomedical reserves the right to change products and specifications without prior notice.



# -40°C Smart Frequency Conversion Biomedical Freezer



DW-40L818BP

## Product Features

- High-efficiency and energy-saving compressor and system**  
 Optimized refrigeration system with a high efficiency inverter compressor to reduce energy consumption
- Green and environmentally friendly**  
 Hydrocarbon refrigerant, energy saving and environmental protection, built with Urethane foam insulation complies with European ROHS regulation
- Superior temperature uniformity in a large storage space**  
 Built-in evaporator design, and the shelf height can be adjusted according to the size of the stored articles, so as to realize the efficient use of large space in the cabinet.  
 The temperature uniformity is  $\pm 3^{\circ}\text{C}$  with the setting temperature of  $-40^{\circ}\text{C}$ .
- Low sound level**  
 Noise level less than 45 dB, providing a more comfortable environment

## Specifications

Model		DW-40L818BP	
Technical Data	Cabinet Type	Upright	
	Climate Class	SN N	
	Cooling Type	Direct Cooling	
	Defrost Mode	Manual	
	Refrigerant	HC	
	Sound Level (dB(A))	44 (220V/50Hz)	
Performance	Cooling Performance ( $^{\circ}\text{C}$ )	-40	
	Temperature Range ( $^{\circ}\text{C}$ )	-20--40	
Control	Controller	Microprocessor	
	Display	LED	
Electrical Data	Power Supply (V/Hz)	100-230/50/60	
	Power (W)	795	
	Electrical Current (A)	7.9	
Dimensions	Capacity (L/Cu.Ft)	818/28.9	
	Net/Gross Weight (approx)	(kg)	210/240
		(lbs)	463.0/529.1
	Interior Dimension (W*D*H)	(mm)	750*755*1460
		(in)	29.5/29.7/57.5
	Exterior Dimension (W*D*H)	(mm)	988*951*1980
		(in)	38.9/37.4/78.0
	Packing Dimension (W*D*H)	(mm)	1040*1035*2110
(in)		40.9*40.7*83.1	
Container Load (20'/40'/40'H)		10/22/22	
Alarms	High/Low Temperature	Y	
	Remote Alarm	Y	
	Power Failure	Y	
	Sensor Error	Y	
	Low Battery	Y	
	High Ambient Temperature	Y	
	Door Ajar	Y	
	Castor	Y	
Accessories	Foot	Y	
	Porthole	Y	
	Drawers/Inner Doors	-/3	
	USB Interface	Optional	
	RS485	Y	
Others	Temperature Recorder	Optional	
	Certificate	CE	

## Ergonomic Design

**Microprocessor-controlled system**  
 Microprocessor control, with temperature display precision at  $0.1^{\circ}\text{C}$ . Internal temperature is adjustable from  $-20^{\circ}\text{C}$  to  $-40^{\circ}\text{C}$ .

**Multiple alarm functions**  
 Including high/ low temperature, sensor error, power failure, low battery, high ambient, and door ajar alarms. Alarm mode is sound and flash. And the remote alarm interface is available

**Configuration**  
 Standard: RS485 interface  
 Optional: Temperature recorder, USB interface, 10-inch touch screen

**Safe and secure**  
 Equipped with key lock, padlock, optional electronic lock, providing multiple safeguards for sample safety

**Porthole**  
 Two portholes as standard, allows for independent testing of cabinet temperature

## Temperature Curve

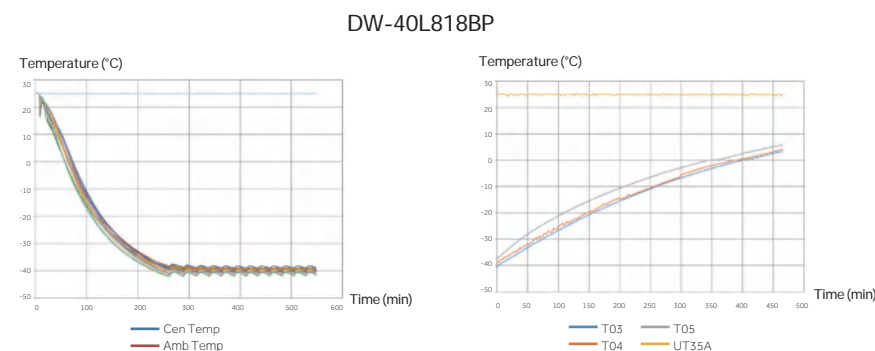

\*Haier Biomedical reserves the right to change products and specifications without prior notice.

## Specifications



Model	DW-40L92		DW-40L262		DW-40L278		DW-40L348		DW-40L508		DW-40L818BP		
Technical Data	Cabinet Type	Upright		Upright		Upright		Upright, Double Door		Upright, Double Door		Upright	
	Climate Class	SN N		SN N		SN N		SN N		SN N		SN N	
	Cooling Type	Direct Cooling		Direct Cooling		Direct Cooling		Direct Cooling		Direct Cooling		Direct Cooling	
	Defrost Mode	Manual		Manual		Manual		Manual		Manual		Manual	
	Refrigerant	HC		HC	CFC-Free	HC	CFC-Free	HC		HC	CFC-Free	HC	
	Sound Level (dB(A))	29		41	44	40	44	41		41	45	44 (220/50)	
Performance	Cooling Performance (°C)	-40		-40		-40		-40		-40		-40	
	Temperature Range (°C)	-20~-40		-20~-40		-20~-40		-20~-40		-20~-40		-20~-40	
Control	Controller	Microprocessor		Microprocessor		Microprocessor		Microprocessor		Microprocessor		Microprocessor	
	Display	LCD		LCD		LED		LED		LED		LED	
Electrical Data	Power Supply (V/Hz)	220-240/50/60		220-240/50/60	115/60	220-240/50	220-240/50/60	220-240/50		220-240/50	208-230/60	100-230/50/60	
	Power (W)	340		310	600	275	370	280		285	510	795	
	Electrical Current (A)	2.2		2	7.5	2.9	5.1	2.9		2.9	5.6	7.9	
	Power Consumption (kWh/24h)	1.4		2.6	4.3	3.1	5.3	3.3		3.8	6.6	/	
Construction	Capacity (L/Cu.Ft)	92/3.2		262/9.3		278/9.8		348/12.3		490/17.3		818/28.9	
	Net/Gross Weight (approx)	kg	46/51		88/93		115/135		137/145		164/200		210/240
		lbs	101.4/112.4		194.0/205.0		253.5/297.6		302.0/320.0		361.6/440.9		463.0/529.1
	Interior Dimensions (W*D*H)	mm	435*410*635		480*465*1430		520*435*1230		535*610*1228		685*610*1228		750*755*1460
		in	17.1*16.1*25.0		18.9*18.3*56.3		20.5*17.1*48.4		21.1*24.0*48.3		27.0*24.0*48.3		29.5/29.7/57.5
	Exterior Dimensions (W*D*H)	mm	640*610*810		700*705*1665		770*710*1810		790*845*1860		940*845*1860		988*951*1980
in		25.2*24.0*31.9		27.6*27.8*65.6		30.3*28.0*71.3		31.1*33.3*73.2		37.0*33.3*73.2		38.9/37.4/78.0	
Packing Dimensions (W*D*H)	mm	660*700*910		775*760*1880		840*770*2000		852*927*2044		1005*940*2040		1040*1035*2110	
	in	26.0*27.6*35.8		30.5*29.9*74.0		33.0*30.3*78.7		33.5*36.5*80.5		39.6*37.0*80.3		40.9*40.7*83.1	
Loading Quantities	Container Load (20'/40'/40'H)	48/108/108		21/45/45		21/42/42		12/28/28		12/24/24		10/22/22	
Alarms	High/Low Temperature	Y		Y		Y		Y		Y		Y	
	Remote Alarm	Y		Y		Y		Y		Y		Y	
	Power Failure	Y		Y		Y		Y		Y		Y	
	Sensor Error	Y		Y		Y		Y		Y		Y	
	Low Battery	/		/		Y		Y		Y		Y	
	High Ambient Temperature	Y		Y		Y		Y		Y		Y	
	Door Ajar	Y		Y		Y		/		/		Y	
Accessories	Caster	Y		Y		Y		Y		Y		Y	
	Foot	Y		Y		Y		Y		Y		Y	
	Porthole	Y		Y		Y		Y		Y		Y	
	Drawers/Inner Doors	3/-		7/-		6/-		12/-		10/-		-/3	
	USB Interface	Optional		Optional	/	Optional		Optional		Optional		Optional	
	RS485	Optional		Optional		Optional		Optional		Optional		Y	
Temperature Recorder	/		/		Optional		Optional		Optional		Optional		
Certification	CE	Y		Y	/	Y		Y		Y		CE	

## Specifications



Model	DW-40W138J	DW-40W255J	DW-40W380J	DW-40L298J	DW-40L568J	DW-40L418D	DW-40L528D	
Technical Data	Cabinet Type	Chest	Chest	Chest	Upright	Upright	Upright	
	Climate Class	SNN	SNN	SNN	SNN	SNN	SNN	
	Cooling Type	Direct Cooling	Direct Cooling	Direct Cooling	Direct Cooling	Direct Cooling	Direct Cooling	
	Defrost Mode	Manual	Manual	Manual	Manual	Manual	Manual	
	Refrigerant	HC	HC	HC	HC	HC	HC	
	Sound Level (dB(A))	42	42	42	39.2	45	41.7	45
Performance	Cooling Performance (°C)	-40	-40	-40	-40	-40	-40	
	Temperature Range (°C)	-20~-40	-20~-40	-20~-40	-20~-40	-20~-40	-20~-40	
Control	Controller	Microprocessor	Microprocessor	Microprocessor	Microprocessor	Microprocessor	Microprocessor	
	Display	LCD	LCD	LCD	LED	LCD	LED	
Electrical Data	Power Supply (V/Hz)	220-240/50	220-240/50	220-240/50	220-240/50	220-240/50	220-240/50	
	Power (W)	260	370	450	570	340	630	
	Electrical Current (A)	2.3	3.1	2.9	4.1	2.8	4.2	
	Power Consumption (kWh/24h)	/	/	/	/	4	/	
Construction	Capacity (L/Cu.Ft)	138/3.9	255/9.0	380/13.4	298/10.5	568/20.1	418/14.8	
	Net/Gross Weight (approx)	kg	52/65	76/96	90/115	125/140	190/215	145/165
		lbs	114.6/143.3	167.5/211.6	198.4/253.5	275.6/308.6	418.9/474	319.7/363.8
	Interior Dimensions (W*D*H)	mm	580*445*620	1000*445*620	1450*445*620	541*443*1218	610*755*1260	554*620*1230
		in	22.8*17.5*24.4	39.4*17.5*24.4	57.1*17.5*24.4	21.3*17.4*48.0	24/29.7/49.6	21.8*24.4*48.4
	Exterior Dimensions (W*D*H)	mm	790*770*950	1210*770*950	1655*770*950	770*710*1828	848*951*1780	790*845*1878
		in	31.1*30.3*37.4	47.6*30.3*37.4	65.2*30.3*37.4	30.3*28.0*72.0	33.4/37.4/70.1	31.1*33.3*73.9
	Packing Dimensions (W*D*H)	mm	840*810*1000	1260*810*1000	1710*815*990	840*770*2000	910*1040*1930	860*930*2040
in		33.1*31.9*39.4	49.6*31.9*39.4	67.3*32.1*39.0	33.0*30.3*78.7	35.8*40.9*76.0	33.9*36.6*80.3	
Loading Quantities	Container Load (20'/40'/40'H)	28/56/56	16/36/54	12/28/28	21/42/42	10/22/22	12/24/26	
Alarms	High/Low Temperature	Y	Y	Y	Y	Y	Y	
	Remote Alarm	Optional	Optional	Optional	Y	Y	Y	
	Power Failure	Y	Y	Y	Y	Y	Y	
	Sensor Error	Y	Y	Y	Y	Y	Y	
	Low Battery	/	/	/	Y	/	Y	
	High Ambient Temperature	Optional	Optional	Optional	Y	Y	Y	
	Door Ajar	/	/	/	Y	Y	Y	
Accessories	Caster	Y	Y	Y	Y	Y	Y	
	Foot	/	/	/	Y	Y	Y	
	Porthole	Y	Y	Y	Y	Y	Y	
	Drawers/Inner Doors	/	/	/	Optional/2	- / 2	Optional/2	
	USB Interface	Optional	Optional	Optional	Optional	Optional	Optional	
	RS485	(USB or RS485, either-or)	(USB or RS485, either-or)	(USB or RS485, either-or)	Optional	Optional	Optional	
	Temperature Recorder	/	/	/	Optional	Optional	Optional	
Certification	CE	Y	Y	Y	Y	Y	Y	



# -30°C Biomedical Freezer (Forced Air Cooling)

## Typical Installation and Application

Large capacity, double door biomedical freezer, designed and manufactured for the low temperature storage of plasma, biological products and other items.



DW-30L1280F

## Product Advantages

Microcomputer control, LED digital temperature display with inside temperature accuracy of 0.1°C

Supersized double outer doors, 70mm insulation layer

Safe lock  
Electronic mortise lock design, with NFC clocking-in function (fingerprint optional)



Low noise

Casters and feet  
4 omnidirectional casters + 2 level legs, easy to move, lock and level

Bottom strainer drawable design  
Easy to clean



Optimized system  
Ensures fast cool down, reaches -30°C within 3 hours

Standard USB port  
Capable of storing more than 15 years of data



# -30°C Biomedical Freezer (Forced Air Cooling)

## Key Features



### Intelligent Defrosting: Prolongs the Defrosting Cycle, Safeguarding the Stability of the Storage Temperature

Compared with traditional timed defrosting, the intelligent defrosting technology reduces the defrosting frequency by half, effectively draws down the temperature fluctuation caused by defrosting during the sample storage cycle by intelligently identifying the amount of frost on the evaporator.



### Advanced Defrosting Technology Optimised Safety

The automatic hot gas defrosting technology eliminates the risk of electrical leakage which can occur with heated wire defrosting techniques.



### Dual Independent Refrigeration Systems: Superior Safety

If one system fails, the other one would reach -25°C quickly, which doubles the safety of the sample; With air cooling technology, the inside uniformity can reach  $\pm 3^{\circ}\text{C}$  ( $\pm 5^{\circ}\text{C}$  during the defrosting period).



### Green Hydrocarbon Refrigeration

The DW-30L1280F utilises HC refrigeration technology which is energy-efficient and has a zero impact on the ozone layer. The energy consumption of this model is 8kW/24H.

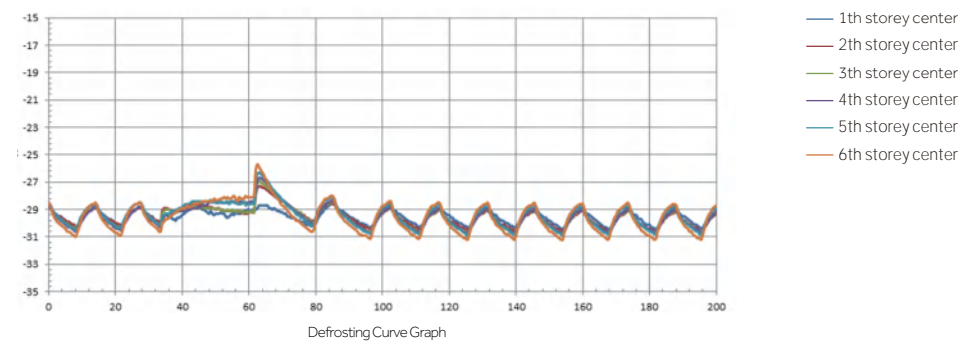
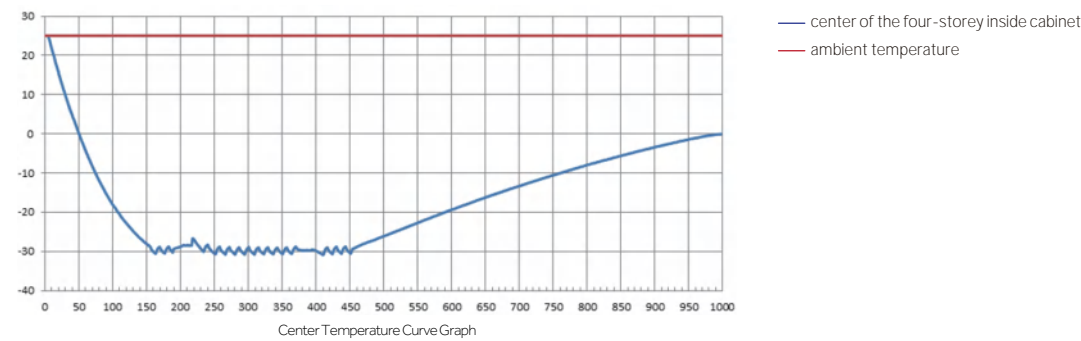

Applied for the storage of critical and temperature sensitive biological samples, laboratory products and medical products. Suitable for blood banks, hospitals, disease control centers, research laboratories.



DW-30L520F

## Product Features



### Forced Air and Auto Defrost Design

-30°C storage temperature with automatic defrost cycles guided by time and temperature, ensure maximum temperature stability and minimize energy consumption



### Superior Temperature Uniformity

The temperature uniformity is  $\pm 3^{\circ}\text{C}$  with the setting temperature of  $-30^{\circ}\text{C}$



### High-efficiency and Energy-saving Compressor and System

High-efficiency hydrocarbon compressor, optimized refrigeration system and low power consumption



### Green and Environmentally Friendly

Hydrocarbon refrigerant, energy saving and environmental protection, built with LBA foam insulation, the GWP is close to 0



### Microprocessor-controlled System

Microprocessor control, with temperature display precision at  $0.1^{\circ}\text{C}$ . Internal temperature is adjustable from  $-10^{\circ}\text{C}$  to  $-30^{\circ}\text{C}$



### Safe and Secure

Designed with key lock, padlock, optional electronic lock, providing multiple safeguards for sample safety



### Low Noise Design

Noise-reduction features and structure noise reduction design



### Configuration

- Standard: 4 layer adjustable shelves
- Optional: 10-inch touch screen, USB interface, NFC, chart recorder, stainless steel self, blood basket



### Multiple Alarm Functions

Including high/low temperature alarm, sensor error alarm, power failure alarm, low battery alarm, door ajar alarm, high ambient temperature alarm, condenser dirty alarm. Alarm mode is sound and flash

# -30°C Biomedical Freezer (Forced Air Cooling)

### Exceptional cooling

Air-forced cooling combined with automatic defrost technology for high-performance cooling

### Access port

Designed with two standard access ports on the left and right sides of the freezer, convenient for users to conduct independent testing

### Adjustable shelves

4 adjustable shelves, (optional: stainless steel shelf, blood basket)

### Safe and secure

Designed with key lock, padlock, optional electronic lock, providing multiple safeguards for sample safety



### Microprocessor temperature control, LED display panel (optional: 10-inch touch screen)

LED displays cabinet temperature with 0.1°C resolution, ambient temperature, and input voltage

### Feet and casters

4 back-and-forth casters and 2 adjustable feet for easy moving and leveling

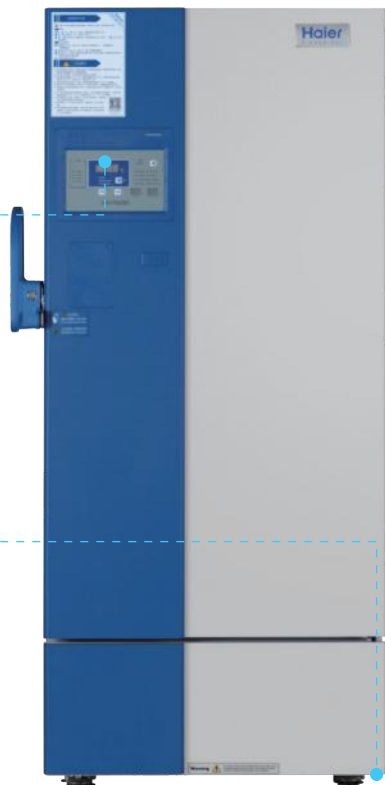

This freezer is designed for storage of critical and temperature sensitive biological samples, laboratory products and medical products in institutions such as blood banks, hospitals and research laboratories.

## Key Features

- Forced air and auto defrost design: -30°C storage temperature with automatic defrost cycles guided by time and temperature, ensure maximum temperature stability and minimize energy use
- High-performance refrigeration system: achieves excellent temperature uniformity with intelligent operation control at -30°C
- Microprocessor control with digital display: 0.1° C control increments, adjustable range of -10°C to -30°C



Door lock and padlock



Backup battery protection



USB



Malfunction Alarms

## DW-30L420F



Drawer (Optional)



Microprocessor control panel



Air distribution



# -30°C Biomedical Freezer (Forced Air Cooling)

## Safety

- The alarm system includes audible and visual alerts. Alarms include high and low temperature, sensor error, power failure, door ajar, low battery and high ambient temperature. Remote contacts are standard
- A backup battery ensures the display and display continue to operate in the event of a power failure for up to 48hrs
- The standard USB port on DW-30L420F allows users to download temperature data
- Lockable door with padlock facility for added sample security



## Ergonomic Design

- Self-closing door with 90° stay-open feature conserves energy and helps maintain temperature uniformity to protect your valuable samples
- Corrosion-free interior brushed stainless steel liner and exterior-coated steel plate
- 5 adjustable stainless steel shelves and optional drawer
- Casters and levelling legs, easy to move and lock

## Temperature Curve

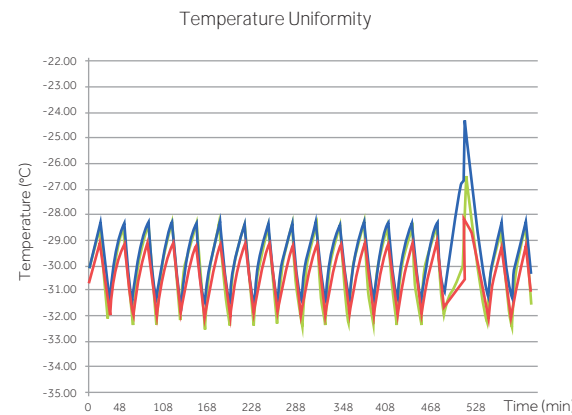
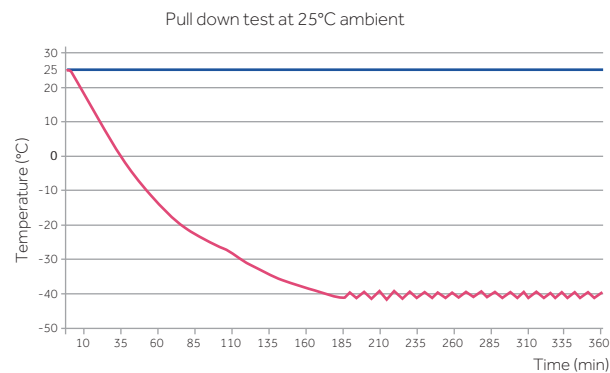

\*Freezer set-point -30 °C, ambient temperature 25 °C

## Specifications

	Model	DW-30L420F	DW-30L520F	DW-30L1280F	
Technical Data	Cabinet Type	Upright	Upright	Upright	
	Climate Class	SNN	SNN	N	
	Cooling Type	Forced Air Cooling	Forced Air Cooling	Forced Air Cooling	
	Defrost Mode	Automatic Defrost	Automatic Defrost	Automatic Defrost	
	Refrigerant	HC	HC	HC	
Performance	Sound Level (dB(A))	46	44   45	46	
	Cooling Performance (°C)	-30	-30	-30	
	Temperature Range (°C)	-10--30	-10--30	-10--30	
Control	Controller	Microprocessor	Microprocessor	Microprocessor	
	Display	LED	LED	LED	
Electrical Data	Power Supply (V/Hz)	220-240/50   208-230/60	220-240/50   208-230/60	220-240/50	
	Power (W)	460/1000 (Defrost)	650   495	900	
	Electrical Current (A)	4.0/5.8 (Defrost)	3.1   2.9	5	
Dimensions	Capacity (L/Cu.Ft)	420/14.8	520/18.4	1280/45.2	
	Net/Gross Weight (approx)	(kg)	195/225	210/252	420/480
		(lbs)	429.9/496.0	463.0/555.6	925/1057
	Interior Dimension (W*D*H)	(mm)	685*610*1028	610*755*1006	1320*752*1260
		(in)	27.0*24.0*40.5	24/29.7/39.6	52/29.6/49.6
	Exterior Dimension (W*D*H)	(mm)	950*920*1900	848*1011*1780	1520*1065*1996
		(in)	37.4*36.2*74.8	33.4/39.8/70.1	59.8/41.9/78.6
Packing Dimension (W*D*H)	(mm)	980*935*2040	900*1060*1920	1580*1100*2100	
	(in)	38.6*36.8*80.3	35.4*41.7*75.6	62.2*43.3*82.7	
Alarms	Container Load(20'/40'/40'H)	12/24/24	10/22/22	6/14/14	
	High/Low Temperature	Y	Y	Y	
	Remote Alarm	Y	Y	Y	
	Power Failure	Y	Y	Y	
	Sensor Error	Y	Y	Y	
	Low Battery	Y	Y	Y	
	High Ambient Temperature	Y	Y	Y	
	Door Ajar	Y	Y	Y	
Accessories	Castor	Y	Y	Y	
	Foot	Y	Y	Y	
	Porthole	Y	Y	Y	
	Drawers/Inner Doors	-/3   6/-	/	/	
	Shelves	5	4	12	
	USB Interface	Y   Optional	Optional	Y	
	RS485	Optional	Y	Y	
	NFC	N	Optional	Y	
Others	Temperature Recorder	Optional	Optional	/	
	Certification	CE   /	CE   /	CE	

F suffix - Forced air cooling  
Product appearance and specifications are subject to change without notice

## Typical Installation and Application

Suitable for sample storage within blood banks, hospitals, disease control centres, research institutes, electronic, chemical and other industries, cryopreservation of plasma, biologics and other products, also suitable for cold tests for components and materials.



DW-30L818BP

### Key Features



**Energy-efficient Variable Frequency Inverter Technology**

Optimized refrigeration system with a high-efficiency inverter compressor to reduce energy consumption.



**Large Capacity Storage with Excellent Temperature Uniformity**

The unit offers a large storage space with adjustable shelves, the built-evaporator ensures quick temperature pull down times and excellent temperature uniformity of  $\pm 3^{\circ}\text{C}$ .



**Low Noise**

Sound reduction design lowers the sound level to 37dB(A) at 220V/50Hz.



**Environment Friendly**

1) HC refrigeration system contains zero chlorine and fluorine, which is better for the environment.  
2) Urethane foam insulation complies with European ROHS regulation.

## Product Advantages

Ergonomic Design: document holding compartment for storing size A4 paper and pens.

Optional USB port allows users to download temperature data saved up to 10 years for compliance and auditing purposes.

Double door seals for better insulation performance.

Microprocessor temperature control: LED displays cabinet temperature with 0.1°C resolution, ambient temperature, and input voltage.



Pressure equalization port for easy door opening.

Ergonomic handle design: easy access to storage space, built in lock and padlock features.

Inner door design reduces loss of cold air to improve energy efficiency and stable temperature.

Casters and leveling legs for ease of maneuvering and positioning.

DW-30L818BP

Optional stainless steel shelves or coated steel are adjustable.



Power coating galvanized interior with large round corner design, corrosion resistance and easy to clean.



Plastic ABS drawer (optional): 25 blood bags (450ml/bag) can be loaded for one drawer, totally 750 blood bags for 30 drawers. (Note: The dimension of one blood bag is 125\*26\*190mm)

## -30°C Smart Frequency Conversion Biomedical Freezer

### Microprocessor Control System

- Microprocessor-based temperature control.
- Large LED displays cabinet temperature with 0.1 °C resolution with adjustable temperature setting from -10 °C to -30 °C.
- Cabinet temperature, ambient temperature and voltage are shown on the panel.
- Alarm conditions include high and low temperature, sensor error, power failure, low battery, door ajar and high ambient.
- Alarm modes are audible and flashing lights. Remote alarm terminals are available.
- Battery supports display and alarm system for forty-eight hours after power outage.
- Optional features are IoT module, USB port, temperature recorder and NFC swipe card functions.

### Insulation

- 70 mm thick insulation.
- Inner doors for better thermal efficiency.

### Porthole

Two standard portholes allow ease of temperature testing.

### Security Lock

Lock is standard. Magnetic lock is optional for added protection and security

### Temperature Recorder

Optional temperature recorder for temperature recording and compliance.



## -30°C Biomedical Freezer (Direct Cooling)

### Typical Installation and Application

For use in blood banks, hospitals, research institutions, electronics, chemical and other industries, for the preservation of plasma and biological products and cryogenic test of components and materials.



DW-30L818

### Key Features



**Energy Efficient Hydrocarbon (HC) Refrigeration System**  
Optimized refrigeration system, utilising high-efficiency HC compressor significantly reduces energy consumption.



**Greener By Design**  
HC refrigerants are natural non-toxic and more environmentally friendly than HFC refrigerants. This alongside the HC compressor technology and LBA foamed polyurethane insulation layer, make this unit greener and in-line with European ROHS directives and environmental protection guidelines.



**Large Capacity, Superior Uniformity**  
Built-in evaporator for faster cooling speed and uniform temperature throughout the cabinet,  $\pm 3^{\circ}\text{C}$ . Large internal space with adjustable shelves for flexible configuration.



**Low Noise**  
Optimized system and cabinet design ensures low noise emissions, less than 44dB.

### Typical Performance Characteristics at 25°C ambient

— Ambient Temp.  
— Center Temp.

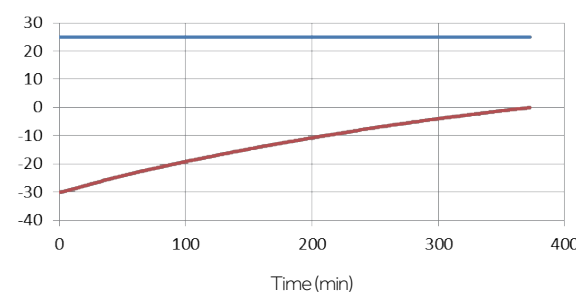
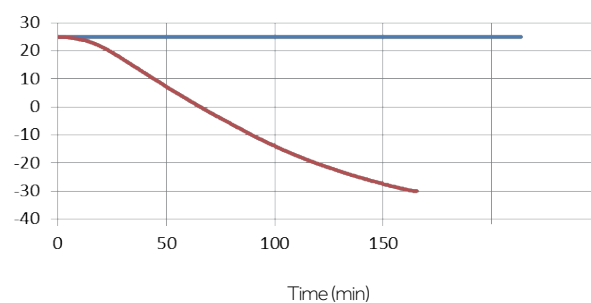

### Typical Performance Characteristics at 25°C ambient

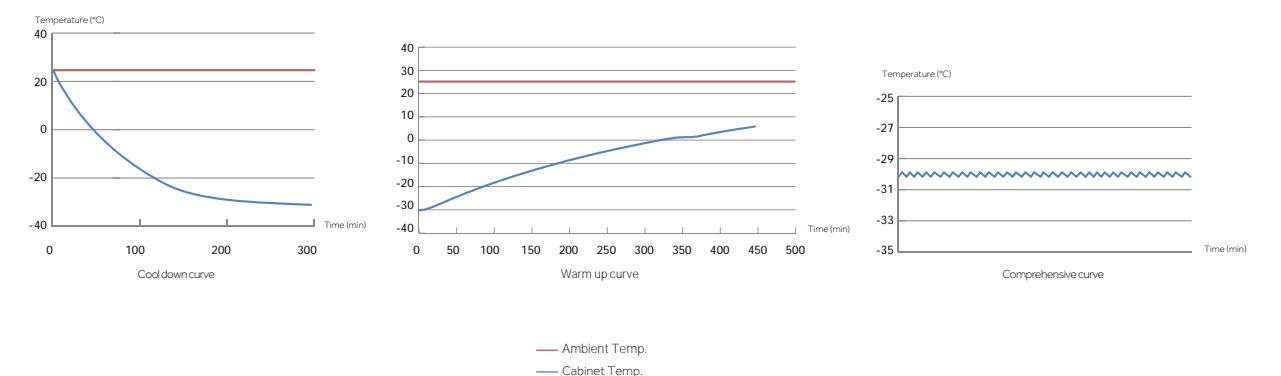



# -30°C Biomedical Freezer (Direct Cooling)

## Product Advantages

**Ergonomic Handle Design:** easy access to storage space, built in lock and padlock features.

**Easy to clean and Corrosion Resistant:** Electric zinc plate powder sprayed internal liner and large round corner design and coated steel plate exterior design ensure reliable corrosion prevention which is easy to clean.

**Double Seal Design:** Provides better insulation and saves energy.

**Inner doors:** prevent rapid loss of cold air, saving energy and reducing temperature fluctuations.

**4 multi-directional casters and 2 lockable feet:** make it easy to move, level and lock in place.

**DW-30L818**

**Microcomputer electronic thermostat:** LCD digital display of inside temperature, with 0.1°C display accuracy.

**Flexible Internal Storage:** Equipped with 5 plastic coated steel wire shelves with optional stainless steel shelves, which are adjustable to meet the different requirements of users.

**Plastic ABS drawer (optional):** 25 blood bags (450ml/bag) can be loaded for one drawer, a totally 750 blood bags for 30 drawers. (Note: The dimension of one blood bag is 125\*26\*190mm)

## Specifications

	Model	DW-30L818	DW-30L818BP	
Technical Data	Cabinet Type	Upright	Upright	
	Climate Class	SNN	SN N	
	Cooling Type	Direct cooling	Direct cooling	
	Defrost Mode	Manual	Manual	
	Refrigerant	HC	HC	
	Sound Level (dB(A))	44	37	
Performance	Cooling Performance (°C)	-30	-30	
	Temperature Range (°C)	-10--30	-10--30	
Control	Controller	Microprocessor	Microprocessor	
	Display	LCD	LED	
Electrical Data	Power Supply (V/Hz)	220~240/50	100-230/50/60	
	Power (W)	380	680	
	Electrical Current (A)	2.8	7.7	
Dimensions	Capacity (L/Cu.Ft)	818/28.9	818/28.9	
	Net/Gross Weight (approx)	(kg)	205/235	210/240
		(lbs)	451.9/518.1	463.0/529.1
	Interior Dimension (W*D*H)	(mm)	750*755*1460	750*755*1460
		(in)	29.5/29.7/57.5	29.5/29.7/57.5
	Exterior Dimension (W*D*H)	(mm)	988*951*1980	988*951*1980
		(in)	38.9*37.4*78.0	38.9*37.4*78.0
Packing Dimension (W*D*H)	(mm)	1040*1035*2110	1040*1035*2110	
	(in)	40.9*40.7*83.1	40.9*40.7*83.1	
Container Load(20'/40'/40'H)		10/22/22	10/22/22	
Alarms	High/Low Temperature	Y	Y	
	Remote Alarm	Y	Y	
	Power Failure	Y	Y	
	Sensor Error	Y	Y	
	Low Battery	N	Y	
	High Ambient Temperature	Y	Y	
	Door Ajar	Y	Y	
Accessories	Castor	Y	Y	
	Foot	Y	Y	
	Porthole	Y	Y	
	Drawers/Inner Doors	-/3	-/3	
	Shelves	5	5	
	USB Interface	Optional	Optional	
	RS485	Optional	Y	
	NFC	N	Optional	
Others	Temperature Recorder	Optional	Optional	
	Certification	CE	CE, UL, ENERGY STAR	

BP suffix - Variable frequency inverter compressor

Product appearance and specifications are subject to change without notice

# -30°C Biomedical Freezer (Direct Cooling)

111/112





## Typical Installation and Application

Suitable for blood banks, hospitals, disease control centers, research institutes, electronic, chemical and other industries. Used for the cryopreservation of plasma, biologics and other products, and cold tests for components and materials.









DW-30L298J

### Key Features

- 
**Adjustable storage shelf height**  
 Built-in evaporator design, and the shelf height can be adjusted according to the size of the stored articles, so as to ensure the efficiency and use of the large space in the cabinet
- 
**Multiple alarm functions**  
 High/Low temperature/door ajar/power failure/sensor error/high ambient temperature alarm and also equipped with remote alarm interface, alarm mode is sound and flash
- 
**High-efficiency and energy-saving compressor and system**  
 High-efficiency hydrocarbon compressor, optimized refrigeration system and low power consumption
- 
**Green and environmental friendly**  
 Hydrocarbon refrigerant, energy saving and environmental protection, built with LBA foam insulation, complies with European RoHS Directive
- 
**Superior temperature uniformity**

### Ergonomic Design

- 
**Multiple alarms**  
 Alarm functions include high, low temperature, sensor error, power failure, high ambient, and door ajar  
 Alarm mode is sound and flash
- 
**Microprocessor-controlled system**  
 Microprocessor control, with temperature display precision at 0.1°C. Internal temperature is adjustable from -10°C to -30°C
- 
**Configuration**  
 Standard: 3 coated steel wired shelves, remote alarm interface  
 Optional: stainless steel partition board, drawer, temperature recorder, RS485 or USB (one out of two)
- 
**Access ports**  
 Two access ports as standard, allows for independent testing of cabinet temperature
- 
**Low noise design**  
 Noise-reduction features and structure noise reduction design
- 
**Safe and secure**  
 Equipped with key lock, padlock, providing multiple safeguards for sample safety



**-30°C Biomedical Freezer (Direct Cooling)**

113/114

**Specifications**

Model		DW-30L298J	
Technical Data	Cabinet Type	Upright	
	Climate Class	SN N	
	Cooling Type	Direct Cooling	
	Defrost Mode	Manual	
	Refrigerant	HC	
	Sound Level (dB(A))	41	
Performance	Cooling Performance (°C)	-30	
	Temperature Range (°C)	-10--30	
Control	Controller	Microprocessor	
	Display	LCD	
Electrical Data	Power Supply (V/Hz)	220-240/50	
	Power (W)	330	
	Electrical Current (A)	2.5	
Dimensions	Capacity (L/Cu.Ft)	298/10.5	
	Net/Gross Weight (approx)	kg	125/140
		lbs	275.6/308.6
	Interior Dimension (W*D*H)	mm	541*455*1218
		in	21.3*17.9*48.0
	Exterior Dimension (W*D*H)	mm	760*695*1828
		in	30.3*28.0*72.0
	Packing Dimension (W*D*H)	mm	832*757*1992
in		32.8*29.8*78.4	
Container Load (20'/40'/40'H)	21/42/42		
Alarms	High/Low Temperature	Y	
	Remote Alarm	Y	
	Power Failure	Y	
	Sensor Error	Y	
	Low Battery	N	
	High Ambient Temperature	Y	
	Door Ajar	Y	
Accessories	Castor	Y	
	Foot	Y	
	Porthole	Y	
	Drawers/Inner Doors	N	
	USB Interface	Optional	
	RS485	Optional	
Others	Temperature Recorder	Optional	
	Certification	CE	

\*Haier Biomedical reserves the right to change products and specifications without prior notice.

**Typical Installation and Application**

Suitable for blood banks, hospitals, disease control centers, research institutes, electronic, chemical and other industries. Used for the cryopreservation of plasma, biologics and other products

**DW-30L528D****Key Features****High-efficiency and energy-saving compressor and system**

High-efficiency hydrocarbon compressor, optimized refrigeration system and low power consumption

**Adjustable storage shelf height**

Built-in evaporator design, and the shelf height can be adjusted according to the size of the stored articles, so as to realize the efficient use of large space in the cabinet

**Green and environmental friendly**

Hydrocarbon refrigerant, energy saving and environmental protection, built with LBA foam insulation, complies with European RoHS Directive

**Multiple alarm functions**

High/Low temperature/door ajar/power failure/sensor error/high ambient temperature alarm and also equipped with remote alarm interface, alarm mode is sound and flash

**Superior temperature uniformity**

The temperature uniformity is  $\pm 3^{\circ}\text{C}$  with the setting temperature of  $-30^{\circ}\text{C}$



# -30°C Biomedical Freezer (Direct Cooling)

115/116

## Ergonomic Design

**Microprocessor-controlled system**  
 Microprocessor control, with temperature display precision at 0.1°C. Internal temperature is adjustable from -10°C to -30°C. Alarm functions include high, low temperature, sensor error, power failure, high ambient, and door ajar. Alarm mode is sound and flash.

**Low noise design**  
 Noise-reduction features and structure noise reduction design

**Safe and secure**  
 Equipped with key lock, padlock providing multiple safeguards for sample safety

**Configuration**  
 Standard: 3 coated steel wired shelves, remote alarm interface  
 Optional: stainless steel partition board, blood basket, drawer, temperature recorder, RS485 or USB (one out of two)

**Porthole**  
 Two portholes as standard, allows for independent testing of cabinet temperature



## Specifications

	Model	DW-30L528D		
Technical Data	Cabinet Type	Upright		
	Climate Class	SNN		
	Cooling Type	Direct cooling		
	Defrost Mode	Manual		
	Refrigerant	HC		
	Sound Level ((dB(A))	39	43	
Performance	Cooling Performance (°C)	-30		
	Temperature Range (°C)	-10~-30		
Control	Controller	Microprocessor		
	Display	LCD		
Electrical Data	Power Supply (V/Hz)	220-240/50	115/60	
	Power (W)	460	420	
	Electrical Current (A)	3.1	5	
Dimensions	Capacity (L/Cu.Ft)	531/18.8		
	Net/Gross Weight (approx)	(kg)	180/205	
		(lbs)	396.8/451.9	
	Interior Dimension (W*D*H)	(mm)	704*620*1230	
		(in)	27.7*24.4*48.4	
	Exterior Dimension (W*D*H)	(mm)	940*845*1878	
		(in)	37.0*33.3*73.9	
Packing Dimension (W*D*H)	(mm)	997*927*2044		
	(in)	39.3*36.5*80.5		
	Container Load(20'/40'/40'H)	12/24/24		
Alarms	High/Low Temperature	Y		
	Remote Alarm	Y		
	Power Failure	Y		
	Sensor Error	Y		
	Low Battery	N		
	High Ambient Temperature	Y		
	Door Ajar	Y		
Accessories	Castor	Y		
	Foot	Y		
	Porthole	Y		
	Drawers/Inner Doors	/		
	USB Interface	Optional		
	RS485	Optional		
	NFC	N		
Temperature Recorder	Optional			
Others	Certification	CE	UL	

\*Haier Biomedical reserves the right to change products and specifications without prior notice.

## -30°C Biomedical Freezer (Direct Cooling)

117/118

Haier Biomedical -30°C biomedical freezer with smart control and energy-saving hydrocarbon refrigeration system for safe and reliable product storage.



DW-30L278



DW-30L508

### Application

Biomedical and life science laboratories within blood banks, hospitals, disease control centres and research institutes as well as electronics and chemical industries. Used for cryopreservation of plasma, biological samples and other products and cold tests for components and materials.

### Advantages

- **High-efficiency and energy-saving compressor and refrigeration system**

Industrial grade energy-saving compressor and optimized cooling system reduces power consumption by more than 55% compared with older models.

- **Green and environmentally friendly**

Hydrocarbon refrigerant compressor system and use of hydrocarbon refrigerants makes the refrigeration system completely green and environmental friendly. Built with isopentane foam polyurethane insulation, which complies with European RoHS Directive.

- **Superior temperature uniformity**

Evaporator-shelf design speeds up the cooling process and provides a more uniform temperature distribution. The temperature uniformity at specific points throughout the unit is  $\pm 4^{\circ}\text{C}$ .

- **Low sound level**

Sound-reducing design with optimized system eliminates high-pitch noise to reduce sound level and deliver a smoother operation

### Key Features



- **Microprocessor control system:**

- Microprocessor temperature controller, LCD temperature display, display accuracy at  $0.1^{\circ}\text{C}$ .
- Adjustable temperature setting from  $-10^{\circ}\text{C}$  to  $-30^{\circ}\text{C}$
- Multiple alarm functions including high temperature alarm, low temperature alarm, sensor error alarm and power failure alarm
- Sound and flash alarm
- Alarm lasts for more than 24 hours after power failure



- **Excellent temperature-retaining ability**

High efficient insulation and double-sealing design improves temperature performance, energy efficiency and system reliability



- **Lock**

Lock latch and key lock double-lock design provides an extra level of security



- **Porthole**

Porthole design is standard



- **Recorder**

Optional chart temperature recorder available



# -30°C Biomedical Freezer (Double Doors Type)

119/120



DW-30L508

### DW-30L508 | TYPICAL PERFORMANCE CHARACTERISTICS AT 25°C AMBIENT

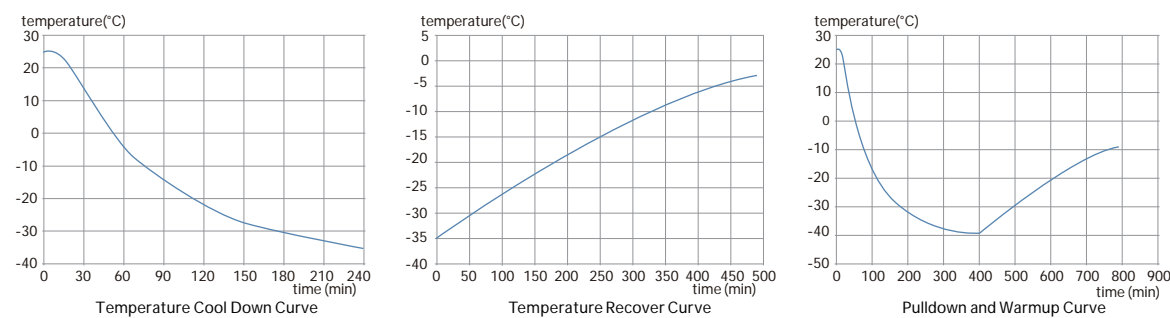

— center air temp

## Specifications

	Model	DW-30L278	DW-30L298J	DW-30L508		
Technical Data	Cabinet Type	Upright	Upright	Upright, Double door		
	Climate Class	SN N	SN N	SN N		
	Cooling Type	Direct cooling	Direct cooling	Direct cooling		
	Defrost Mode	Manual	Manual	Manual		
	Refrigerant	HC	HC	HC		
Performance	Sound Level (dB(A))	40	41	41	43	
	Cooling Performance (°C)	-30	-30	-30		
Control	Temperature Range (°C)	-10~-30	-10~-30	-10~-30		
	Controller	Microprocessor	Microprocessor	Microprocessor		
Electrical Data	Display	LCD	LCD	LCD	LED	
	Power Supply (V/Hz)	220-240/50	220-240/50	220-240/50	115/60	
	Power (W)	330	330	530	600	
Dimensions	Electrical Current (A)	2	2.5	3	5.4	
	Capacity (L/Cu.Ft)	278/9.8	298/10.5	490/17.3		
	Net/Gross Weight (approx)	(kg)	115/135	125/140	164/200	
		(lbs)	253.7/297.7	275.6/308.6	361.6/440.9	
	Interior Dimension (W*D*H)	(mm)	520*435*1230	541*443*1218	685*610*1228	
		(in)	20.5*17.1*48.4	21.3*17.4*48.0	27.0*24.0*48.3	
	Exterior Dimension (W*D*H)	(mm)	745*675*1810	770*710*1828	915*810*1860	
		(in)	29.3*26.6*71.3	30.3*28.0*72.0	36.0*31.9*73.2	
	Packing Dimension (W*D*H)	(mm)	800*740*2000	840*770*2000	980*905*2040	
		(in)	31.5*29.1*78.7	33.1*30.3*78.7	38.6*35.6*80.3	
Alarms	Container Load(20'/40'/40'H)	21/42/45	21/42/42	12/26/26		
	High/Low Temperature	Y	Y	Y	Y	
	Remote Alarm	N	Y	N	Y	
	Power Failure	Y	Y	Y	N	
	Sensor Error	Y	Y	Y	Y	
	Low Battery	N	N	N	N	
	High Ambient Temperature	N	Y	N	N	
	Door Ajar	N	Y	N	N	
Accessories	Castor	Y	Y	Y	Y	
	Foot	Y	Y	Y	Y	
	Porthole	Y	Y	Y	Y	
	Drawers/Inner Doors	6/-	N	10/-		
	Shelves	5	3	4		
	USB Interface	N	Optional	N		
	RS485	N	Optional	N		
	NFC	N	N	N		
	Temperature Recorder	Optional	Optional	Optional		
	Others	Certification	CE	CE	CE	UL



Specifications



	Model	DW-30L278	DW-30L298J	DW-30L508	DW-30L528D	DW-30L818	DW-30L818BP	DW-30L520F	DW-30L1280F	
Technical Data	Cabinet Type	Upright	Upright	Upright, Double Door	Upright, Double Door	Upright	Upright	Upright	Upright	
	Climate Class	SN N	SN N	SNN	SNN	4	SN N	SNN	SN N	
	Cooling Type	Direct Cooling	Direct Cooling	Direct Cooling	Direct Cooling	Direct Cooling	Direct Cooling	Forced air cooling	Forced air cooling	
	Defrost Mode	Manual	Manual	Manual	Manual	Manual	Manual	Automatic defrost	Automatic (Evaporator), Manual (Inner cabinet & Door frame)	
	Refrigerant	HC	HC	HC	HC	HC	HC	HC	HC	
	Sound Level (dB(A))	40	41	41   43	39   43	44	37 (220V/50Hz)	44   45	46	
Performance	Cooling Performance (°C)	-30	-30	-30	-30	-30	-30	-30	-30	
	Temperature Range (°C)	-10--30	-10--30	-10--30	-10--30	-10--30(-35°C at 25°C Ambient Temperature)	-10--30	-10--30	-10--30	
Control	Controller	Microprocessor	Microprocessor	Microprocessor	Microprocessor	Microprocessor	Microprocessor	Microprocessor	Microprocessor	
	Display	LCD	LCD	LCD   LED	LCD	LCD	LED	LED	LED	
Electrical Data	Power Supply (V/Hz)	220-240/50	220-240/50	220-240/50   115/60	220-240/50   115/60	220-240/50	100-230/50/60	220-240/50   208-230/60	220-240/50	
	Power (W)	330	330	530   600	460   420	/	680	650   495	900W (220V/50Hz)	
	Electrical Current (A)	2	2.5	3   5.4	3.1   5	2.8	7.7	3.1   2.9	4.0/5.8 (Defrost)	
	Power Consumption(kWh/24h)	2.3	/	2.8   2.8	/	/	/	/	5	
Construction	Capacity (L/Cu.Ft)	278/9.8	298/10.5	490/17.3	531/18.8	818/28.9	818/28.9	520/18.4	1280/45.2	
	Net/Gross Weight (approx)	kg	115/135	125/140	164/200	180/205	205/235	210/240	210/252	420/480
		lbs	253.7/297.7	275.6/308.6	361.6/440.9	396.8/451.9	451.9/518.1	463/529.1	463.0/555.6	925/1057
	Interior Dimensions (W*D*H)	mm	520*435*1230	541*443*1218	685*610*1228	704*620*1230	750*755*1460	750*755*1460	610*755*1006	1320*752*1260
		in	20.5*17.1*48.4	21.3*17.4*48.0	27.0*24.0*48.3	27.7*24.4*48.4	29.5*29.7*57.5	29.5*29.7*57.5	24/29.7/39.6	52/29.6/49.6
	Exterior Dimensions (W*D*H)	mm	745*675*1810	770*710*1828	915*810*1860	940*845*1878	988*951*1980	988*951*1980	848*1011*1780	1520*1065*1996
in		29.3*26.6*71.3	30.3*28.0*72.0	36.0*31.9*73.2	37.0*33.3*73.9	38.9*37.4*78.0	38.9*37.4*78	33.4/39.8/70.1	59.8/41.9/78.6	
Packing Dimensions (W*D*H)	mm	800*740*2000	840*770*2000	980*905*2040	1005*940*2040	1040*1035*2110	1040*1035*2110	900*1060*1920	1580*1100*2100	
	in	31.5*29.1*78.7	33.1*30.3*78.7	38.6*35.6*80.3	39.6*37.0*80.3	40.9*40.7*83.1	40.9*40.7*83.1	35.4*41.7*75.6	62.2*43.3*82.7	
Loading Quantities	Container Load (20'/40'/40'H)	21/42/45	21/42/42	12/26/26	10/22/24	10/22/22	10/22/22	10/22/22	6/14/14	
Alarms	High/Low Temperature	Y	Y	Y	Y	Y	Y	Y	Y	
	Remote Alarm	/	Y	/   Y	Y	Y	Y	Y	Y	
	Power Failure	Y	Y	Y   /	Y	Y	Y	Y	Y	
	Sensor Error	Y	Y	Y	Y	Y	Y	Y	Y	
	Low Battery	/	N	/	N	N	Y	Y	Y	
	High Ambient Temperature	/	Y	/	Y	Y	Y	Y	Y	
	Door Ajar	/	Y	/	Y	Y	Y	Y	Y	
Accessories	Caster	Y	Y	Y	Y	Y	Y	Y	Y	
	Foot	Y	Y	Y	Y	Y	Y	Y	Y	
	Porthole	Y	Y	Y	Y	/	Y (2)	Y	Y	
	Drawers/Inner Doors	6/-	N	10/-	/	5/3	5/3	/	12	
	USB Interface	/	Optional	/	Optional	Optional	Optional	Optional	Y	
	RS485	/	Optional	/	Optional	Y	Y	Y	Optional	
Temperature Recorder	Optional	Optional	Optional	Optional	Optional	/	Optional	/		
Certification	CE	/	CE	CE   UL	CE   UL	CE	CE, UL, ENERGY STAR	CE   /	CE	

The Haier Biomedical -25°C biomedical freezer maximize storage space. Integrated cold shelf and evaporator design provides maximum refrigeration efficiency.



DW-25L92/262

**Key Features**

- Chemically stable, HC commercially available and environmently safe refrigerant
- High-density foam insulation for rigidity and stable storage temperature
- Microprocessor control, digital display, adjustable temperature range: -10°C~-25°C
- LCD digital display for clear observation
- Wide voltage tolerance design with applicable voltage range of 187~242 V/AC

**Safety**

- Multiple malfunction alarms including high low temperature, sensor error
- Two types of alarm indications: audible buzzing and visible flashing light
- Door lock for storage safety
- Storage drawer

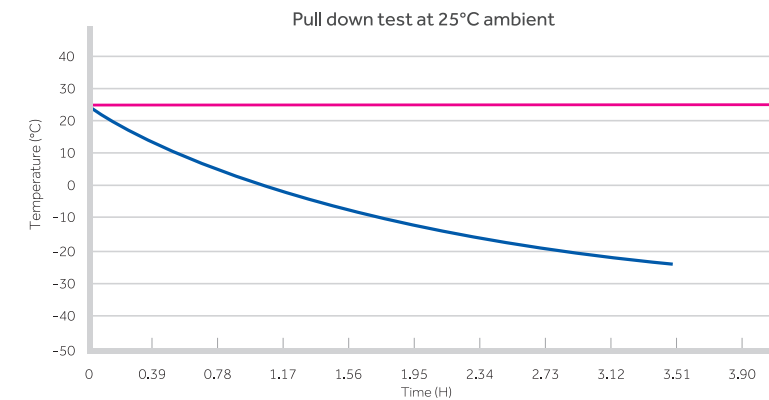

**Specifications**

	Model	DW-25L92		DW-25L262		
Technical Data	Cabinet Type	Upright		Upright		
	Climate Class	SN N		SN N		
	Cooling Type	Direct Cooling		Direct Cooling		
	Defrost Mode	Manual		Manual		
	Refrigerant	HC		HC		
	Sound level ((dB(A))	27	28	34	34	
Performance	Cooling Performance (°C)	-25		-25		
	Temperature Range (°C)	-10~-25		-10~-25		
Control	Controller	Microprocessor		Microprocessor		
	Display	LCD		LCD		
Electrical Data	Power Supply (V/Hz)	220-240/50	115/60	220-240/50	115/60	
	Power (W)	255	125	270	135	
	Electrical Current (A)	1.2	1.8	1.4	2.6	
	Power Consumption (kWh/24h)	0.65	0.49	0.95	0.73	
Construction	Capacity (L/Cu.Ft)	92/3.2		262/9.3		
	Net/Gross Weight (approx)	kg	46/51	88/93		
		lbs	101.4/112.4	194.0/205.0		
	Interior Dimensions (W*D*H)	mm	435*410*635	480*465*1430		
		in	17.1*16.1*25.0	18.9*18.3*56.3		
	Exterior Dimensions (W*D*H)	mm	640*610*810	700*705*1665	700*705*1730	
in		25.2*24.0*31.9	27.6*27.8*65.6	27.6*27.8*68.1		
Packing Dimensions (W*D*H)	mm	660*700*910	775*760*1880			
	in	26.0*27.6*35.8	30.5*29.9*74.0			
Loading Quantities	Container Load (20'/40'/40'H)	48/102/102		21/45/45		
Alarms	High/Low Temp	Y		Y		
	Sensor Error	Y		Y		
	Door Ajar	Y		Y		
	Remote Alarm	Y		Y		
Accessories	Caster	Y		Y		
	Foot	Y		Y		
	Porthole	Y		Y		
	Drawers	3		7		
	USB Interface	Optional		Optional		
Certifications	RS485	Optional		Optional		
	CE	Y	/	Y	/	
UL	/	Y	/	Y		

Product appearance and specifications are subject to change with out notice





Spark Free  
Refrigerator/Freezer



## Typical Installation

Spark free refrigerators are installed typically in many different laboratories and research facilities to store chemical or experimental reagents that are flammable, explosive, evaporative or corrosive.



## Product Advantages

### ATEX II C-T6 E.U. Explosion Proof Certification

Explosion proof features include antistatic liner, gasket, explosion proof fan motor, over current and voltage protection. ATEX II C-T6 explosion proof certification for Haier's laboratory refrigerator ensures safety in your work place.

### 3~16°C Setting Temperature Range

Smart temperature control system limits the temperature variance within  $\pm 3^{\circ}\text{C}$ . Adjustable set point for the range of  $3^{\circ}\text{C} \sim 16^{\circ}\text{C}$ , factory default set temperature is  $5^{\circ}\text{C}$ , controlling the temperature inside the chamber is  $2 \sim 8^{\circ}\text{C}$ .

### One-touch Search for Historic Data

The highest and lowest historic temperature data is saved and can be checked with one keystroke.

### High Efficiency HC Cooling Technology

The hydrocarbon refrigeration system operates at a much higher efficiency and reduces the energy consumption by about 50 percent.

## Ergonomic Design

### High Strength Glass Shelves

Tempered glass shelves hold 40 kg of products per shelf.

### Low Noise

Noise cancelling technology reduces the sound level to less than 40 dB(A) for a much-improved environment.



### Dual Lock Design with Multiple Alarm Systems

A mortise lock is standard on the door. Standard alarms include high and low temperature, door ajar, and sensor errors.



Cabinet Structure



Glass Shelve

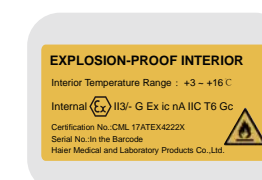

ATEX Certification Label



Explosion Proof Cabinet/Fan

# Spark Free Refrigerator

129/130

## Application Range

Haier spark free refrigerators are ATEX certified in the application range II 3G Ex ic nA II T6, which means the appliances can be found in the whole II zone environment (including II A and II B, II C), a typical environment within many biochemistry laboratories.

### Explosive-proof Rating

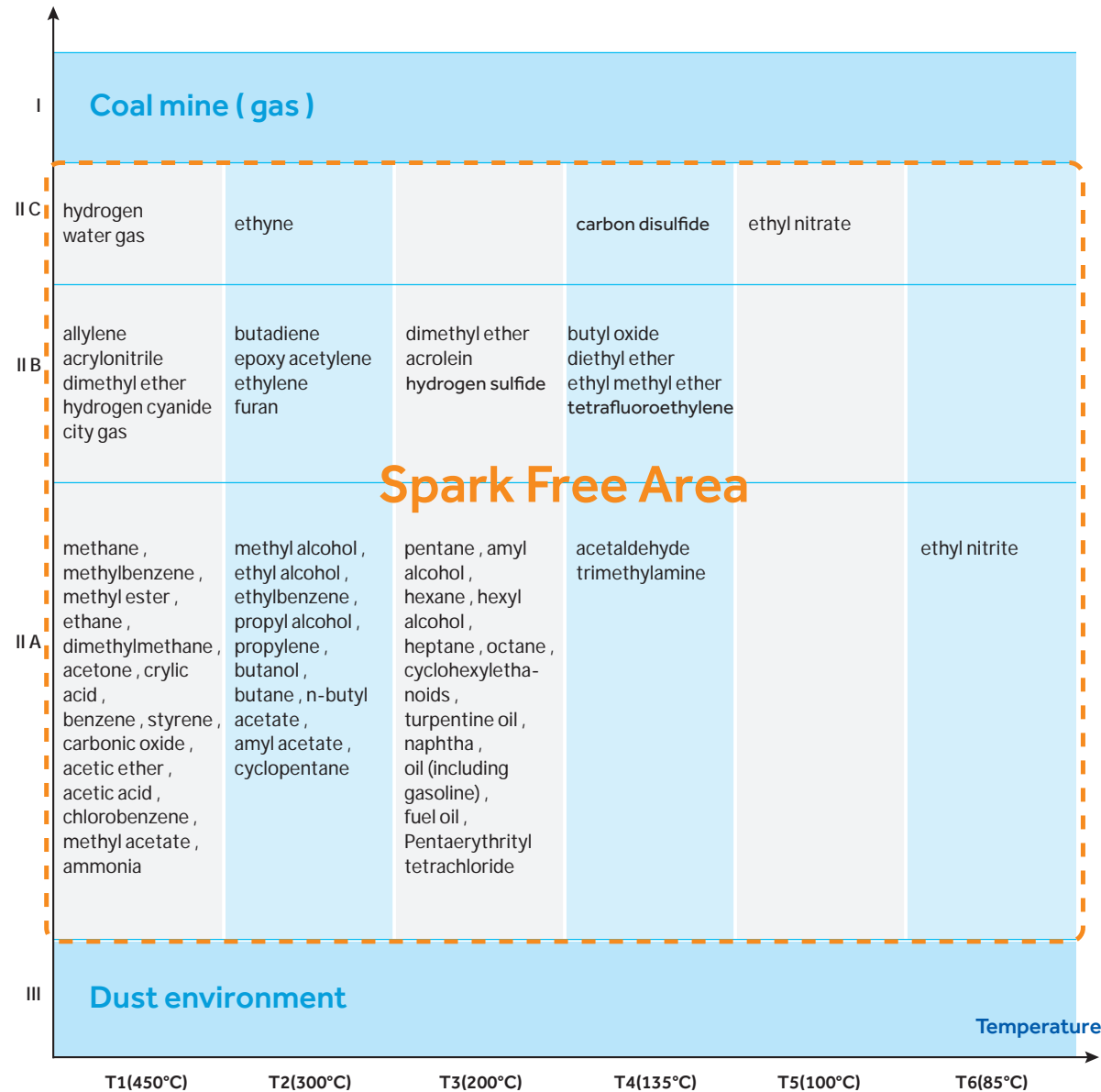

**Warning: Do not store open containers of volatile substances in this refrigerator.**

## Specifications

Model	HLR-118SF	HLR-310SF	HLR-118FL	HLR-310FL
Type	Under-Counter	Upright	Under-Counter	Upright
Climate Class	N	N	N	N
Cooling Type	Forced Air Cooling	Forced Air Cooling	Forced Air Cooling	Forced Air Cooling
Defrost Mode	Auto	Auto	Auto	Auto
Refrigerant	R600a	R600a	R600a	R600a
Sound Level (dB(A))	40	40	40	40
Temperature Range (°C)	3-16°C Adjustable	3-16°C Adjustable	3-16°C Adjustable	3-16°C Adjustable
Ambient Temperature (°C)	16-32	16-32	16-32	16-32
Controller	Microprocessor	Microprocessor	Microprocessor	Microprocessor
Display	LED	LED	LED	LED
Power Supply (V/Hz)	220-240/50	220-240/50	220-240/50	220-240/50
Power (W)	55	210	55	210
Electrical Current (A)	1.2	1.26	1.2	1.26
Power Consumption (kWh/24h)	0.56	1.05	0.56	1.05
Capacity (L/Cu.Ft)	118/4.2	310/10.9	118/4.2	310/10.9
Net/Gross Weight (approx)	kg	44/49	72/83	44/49
	lbs	97/108	158.7/183	97/108
Interior Dimensions (W*D*H)	mm	515*415*630	560*500*1290	515*415*630
	in	20.3*16.3*24.8	22.0*19.7*50.8	20.3*16.3*24.8
Exterior Dimensions (W*D*H)	mm	597*635*810	605*598*1840	597*635*810
	in	23.5*25*31.9	23.8*23.6*73.6	23.5*25*31.9
Packing Dimensions (W*D*H)	mm	680*690*910	660*670*2020	680*690*910
	in	26.8*27.2*35.8	26*26.4*79.5	26.8*27.2*35.8
Container Load (20'/40'/40'H)	48/96/96	24/51/51	48/96/96	24/51/51
High/Low Temperature	Y	Y	Y	Y
Sensor Error	Y	Y	Y	Y
Door Ajar	Y	Y	Y	Y
Caster	2	4	2	4
Foot	2	2	2	2
Shelves/Baskets	2/1	4/0	2/1	4/0
Water Tray	1	1	1	1
Padlock Adapter Kit/Quantity	/	1	/	1
Built-in Key Door Lock/Quantity	1	1	1	1
CE	Y	Y	Y	Y
ATEX	Y	Y	Y	Y

Product appearance and specifications are subject to change without notice

# Combined Refrigerator and Freezer with Spark-free Interior

## Application Range

Used for storage of volatile, unstable, low boiling point (flammable and explosive) compounds/dangerous other items that require a low temperature in pharmaceutical factories and laboratories etc.

## Product Advantages

### High Performance

Refrigerator: Forced-air cooling system with cycle defrost, temperature uniformity  $\pm 3^{\circ}\text{C}$   
 Freezer: Cold wall cooling system, manual defrost, temperature uniformity  $\pm 5^{\circ}\text{C}$   
 Optional USB interface, RS485 & printer, easy to get temperature record

### Microprocessor Controller with Digital Display

Refrigerator temperature  $2\text{--}8^{\circ}\text{C}$  with resolution of  $0.1^{\circ}\text{C}$   
 Freezer temperature  $-30\text{--}-10^{\circ}\text{C}$  with resolution of  $1^{\circ}\text{C}$   
 Multiple alarm functions with remote alarm contact to ensure safe monitoring

### Multipurpose and Space Efficient

One cabinet with two independent chambers, both are self-contained and independently controlled with individual doors

### Stainless Steel Interior

The interior of refrigerator and freezer are both made of stainless steel, which is easy to clean and corrosion-proof

### Environment Friendly

Hydrocarbon refrigerant (R600a for refrigerator/R290 for freezer) and CFC-free polyurethane insulation for reduced global warming potential

### ATEX Certified

### Low Energy Consumption: 1.5 kWh/24h



25°C Ambient Temperature Curve

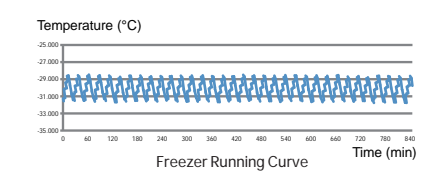
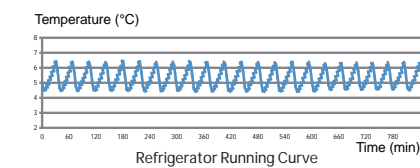
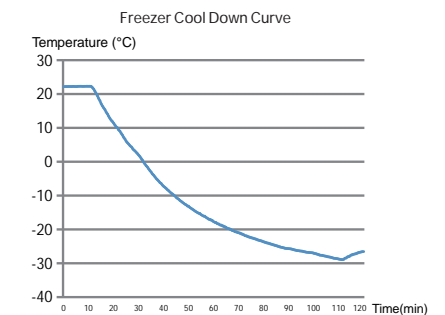
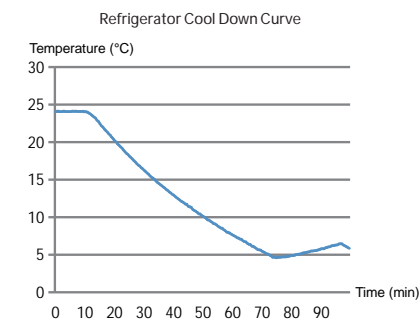



# Combined Refrigerator and Freezer with Spark-free Interior

133/134



## Specifications

Model		HLRF-319SF	
Technical Data	Cabinet Type	Upright	
	Climate Class	N, 16-32°C	
	Cooling Type	Refrigorator: Forced air cooling/Freezer: Direct cooling	
	Defrost Mode	Refrigerator: Auto/Freezer: Manual	
	Refrigerant	Refrigerator: R600a/Freezer: R290	
	Sound Level (dB(A))	43	
Performance	Temperature Range (°C)	Refrigerator: 2-8/Freezer: -10--30	
Control	Controller	Microprocessor	
	Display	LED	
Electrical Data	Power Supply (V/Hz)	220-240-/50	
	Power (W)	230	
	Electrical Current (A)	1.5	
	Power Consumption (kWh/day)	1.5	
Dimensions	Capacity (L/Cu.Ft)	Refrigerator: 219/7.7; Freezer: 100/3.5	
	Net/Gross Weight (approx)	kg	130/140
		lbs	319.7/352.7
	Interior Dimensions (W*D*H)	mm	Refrigerator: 605*510*720/Freezer: 515*465*440
		in	Refrigerator: 23.8*20*28.3/Freezer: 20.2*18.3*17.3
	Exterior Dimensions (W*D*H)	mm	735*660*1810
		in	28.9*26.0*71.3
	Packing Dimensions (W*D*H)	mm	775*720*1930
in		30.5*28.3*76	
Container Load (20'/40'/40'H)		21/43/43	
Alarms	High/Low Temperature	Y	
	Sensor Error	Y	
	Power Failure	Y	
	Door Ajar	Y	
	Low Battery	Y	
	Remote Alarm	Y	
Accessories	Caster	Y/4	
	Foot	Y/2	
	Porthole	N	
	Shelves	Refrigerator: 3; Freezer: 2	
	Stylus Printer	Optional (printer or RS485, either-or)	
	RS485	Optional (printer or RS485, either-or)	
Other	USB Interface	Optional	
	Certification	CE, ATEX	

\*Haier Biomedical reserves the right to change products and specifications without prior notice.

# -30°C Spark Free Freezer

## Typical Installation

It can be used for safe storage of potentially flammable items and other temperature sensitive samples at low temperatures. Applications found within life science, medical, electronics and chemical industries.



DW-30L298SF

## Product Advantages

- Explosion Proof Interior**  
SF series freezers feature standard interior design. FL series freezers feature antistatic interior design. All metal parts are grounded reliably and interior design is explosion proof. Certificates include China anti-explosion proof and EU explosion proof ATEX II C-T6
- Superior Temperature Uniformity**  
The temperature uniformity is  $\pm 3^{\circ}\text{C}$  with the setting temperature of  $-30^{\circ}\text{C}$
- Low Noise Design**  
Noise-reduction features and structure noise reduction design
- High-efficiency and Energy-saving Compressor and System**  
High-efficiency hydrocarbon compressor, optimized refrigeration system and low power consumption
- Green and Environmental Friendly**  
Hydrocarbon refrigerant, energy saving and environmental protection, built with LBA foam insulation, complies with European RoHS Directive
- Multiple Alarm Functions**  
High, Low temperature, door ajar, power failure, sensor error, high ambient temperature alarm and also equipped with remote alarm interface, alarm mode is sound and flash



DW-30L298SF

DW-30L298FL

Laboratory Deep Freezer with explosion-proof interior  
Interior Temp. Range :  $-10 \sim -30^{\circ}\text{C}$  ( DW-30L298FL/SF )  
Internal  $\text{Ex}$  II 3/ - G Ex ic IIC T6 Gc  
Certification No.-CML 18ATEX4058X  
Serial No.-In the Barcode  
Qingdao Haier Biomedical Co., Ltd.

**Anti-static operating instruction**  
1. Clean plastic parts with a damp cloth only  
2. Do not use a dry cloth to clean plastic parts  
3. Danger of sparks due to electrostatic discharge  
4. Warning - potential electrostatic charging hazard - see instructions

## Ergonomic Design

- Microprocessor-controlled System**  
Microprocessor control with LCD temperature display precision at  $0.1^{\circ}\text{C}$ . Internal temperature is adjustable from  $-10^{\circ}\text{C}$  to  $-30^{\circ}\text{C}$
- Adjustable Shelves**  
The adjustable shelves ensure the maximum usage efficiency of the internal space, and users can store items of different sizes as needed
- Rich Configuration**  
Standard: DW-30L298SF interior material is PCM with 3 plastic coated wire shelves, DW-30L298FL interior material is SUS with 3 chrome-plated wire shelves  
Optional: stainless steel shelves, drawer, temperature recorder, RS485 or USB (one out of two)
- Improved Handle Design**  
The ergonomic chamfer design of the handle ensures smooth operation and maximum durability
- Feet and Casters**  
4 back-and-forth casters and 2 adjustable feet (out of two) for easy moving and leveling

## Application Range

Explosive Proof Rating	I	Coal mine (gas)				
	IIc	hydrogen water gas	ethyne		carbon disulfide	ethyl nitrate
	II B	Allylene acrylonitrile dimethyl ether hydrogen cyanide city gas	butadiene epoxy acetylene ethylene furan	dimethyl ether acrolein hydrogen sulfide	butyl oxide diethyl ether ethyl methyl ether tetr ethylene	
	II A	methane, methylbenzene, methyl ester, ethane, dimethylmethane, acetone, acrylic acid, benzene, styrene, carbonic oxide, acetic ether, acetic acid, chlorobenzene, methyl acetate, ammonia	methyl alcohol, ethyl alcohol, ethylbenzene, propyl alcohol, propylene, butanol, butane, n-butyl acetate, amyl acetate, cyclopentan	Pentane, amyl alcohol, hexane, hexyl alcohol, heptane, octane, cyclohexylethanoids, turpentine oil, naphtha, oil (including gasoline), fuel oil, Pentaerythrityl tetrachloride	acetalde hyde trimethyl amine	ethyl nitrite
III	Dust environment					
		T1 (450°C)	T2 (300°C)	T3 (200°C)	T4 (135°C)	T5 (100°C) T6 (85°C)
		Temperature				

## Typical Installation

It can be used for safe storage of potentially flammable items and other temperature sensitive samples at low temperatures. Applications found within life science, medical, electronics and chemical industries.

**DW-30L278SF****DW-30L278SF/FL**

## Product Advantages

### Explosion Proof Interior

The SF series is composed of a non-anti-static liner, door lining and drawers; the FL series is composed of an anti-static liner, door lining and drawers. Equipped with an overcurrent and overvoltage protection system with all components earthed to ensure static is discharged safely. Certified to ATEX IIC-T6 EU and can be used in zone 2 environments.

### Hydrocarbon Energy-saving

- Utilizing a hydrocarbon compressor and hydrocarbon refrigerant resulting in a more eco-friendly refrigeration system.
- Cyclo-isopentane foaming polyurethane insulation and manufactured with materials that comply with the European ROHS directive for environmental protection.
- The hydrocarbon energy-saving and high-efficiency compressor results in an optimized refrigeration system which is more energy efficient than older models.

### Excellent Temperature Uniformity

An evaporator shelf design is adopted inside the freezer whereby the evaporation plate serves as a shelf, to ensure faster cooling and a more uniform temperature. The temperature uniformity at points throughout the unit is  $\pm 4^{\circ}\text{C}$ .

### Low Noise

Cabinet structure and refrigeration system noise reduction design lowers noise level to less than 40dB(A) and eliminating any harsh high-frequency noises.

**Laboratory Deep Freezer with explosion-proof interior**  
 Interior Temp. Range : -10 ~ -25 C (DW-25L92FL/SF)  
 -10 ~ -30 C (DW-30L278FL/SF)  
 Internal  IIC-T6 Gc  
 Certification No.: CML 18ATEX4058X  
 Serial No.: In the Barcode  
 Haier Medical and Laboratory Products Co., Ltd.

**Anti-static operating instruction**  
 1. Clean plastic parts with a damp cloth only.  
 2. Do not use a dry cloth to clean plastic parts.  
 3. Danger of sparks due to electrostatic discharge.  
 4. Warning - potential electrostatic charging hazard - see instructions.



**-30°C Spark Free Freezer**

139/140

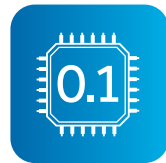
**Key Features****Microprocessor-controlled system**

- Microprocessor electronic thermostat, LCD temperature display to an accuracy of 0.1°C;
- Adjustable set point of between -10~-30°C;
- Alarm functions include a high and low temperature alarm, sensor error alarm and power failure alarm;
- Audible and visual alarm;
- Display/Alarm is battery backed up for 24 hours in the event of a power failure.

**Good thermal insulation**

The super-thick insulation layer and removable door gasket design improves the thermal insulation and energy-saving effects to enhance the reliability of the freezer.

**Warning sticker**

The SF series adopts the non-anti-static liner and front-operated yellow warning sticker to warn users about safe operation requirements and ensure safe use.

**Configuration**

Six plastic drawers (DW-30L278SF)  
Six drawers made of anti-static materials.(DW-30L278FL)  
Adjustable PCM with 3 plastic coated wire shelves  
Adjustable SUS with 3 chrome-plated wire shelves

**Caster**

Caster and levelling feet design, easy to move and fix in place.

**Specifications**

Model	DW-25L92SF	DW-30L278SF	DW-30L298SF	DW-30L298FL		
Technical Data	Cabinet Type	Upright	Upright	Upright	Upright	
	Climate Class	SN N	SN N	SN N	SN N	
	Cooling Type	Direct Cooling	Direct Cooling	Direct cooling	Direct cooling	
	Defrost Mode	Manual	Manual	Manual	Manual	
	Refrigerant	HC	HC	HC	HC	
	Sound Level(dB(A))	27	40	41	41	
Performance	Cooling Performance(°C)	-25	-30	-30	-30	
	Temperature Range (°C)	-10~-25	-10~-30	-10~-30	-10~-30	
Control	Controller	Microprocessor	Microprocessor	Microprocessor	Microprocessor	
	Display	LED	LCD	LCD	LCD	
Electrical Data	Power Supply(V/Hz)	220-240/50	220-240/50	220-240/50	220-240/50	
	Power(W)	255	330	330	330	
	Electrical Current(A)	1.2	2.0	2.5	2.5	
Construction	Capacity(L/Cu.Ft)	92/3.2	278/9.8	298/10.5	298/10.5	
	Net/Gross Weight(approx)	kg	46/51	115/135	125/140	125/140
		lbs	101.4/112.4	254/298	275.6/308.6	275.6/308.6
	Interior Dimensions(W*D*H)	mm	435*410*635	520*435*1230	541*443*1218	541*443*1218
		in	17.1*16.1*25.0	20.5*17.1*48.4	21.3*17.4*48.0	21.3*17.4*48.0
	Exterior Dimensions(W*D*H)	mm	597*635*810	745*675*1810	770*710*1828	770*710*1828
		in	23.5*25*32.9	29.3*26.6*71.3	30.3*28.0*72.0	30.3*28.0*72.0
	Packing Dimensions(W*D*H)	mm	680*690*940	800*740*2000	840*770*2000	840*770*2000
in		26.8*27.1*37.0	31.5*29.1*78.7	33.1*30.3*78.7	33.1*30.3*78.7	
Loading Quantities	Container Load (20'/40'/40'H)	48/102/102	21/42/45	21/42/42	21/42/42	
Alarms	High/Low Temperature	Y	Y	Y	Y	
	Remote Alarm	Y	/	Y	Y	
	Power Failure	N	Y	Y	Y	
	Sensor Error	Y	Y	Y	Y	
	Door Ajar	Y	/	Y	Y	
Accessories	Caster	Y	Y	Y	Y	
	Foot	Y	Y	Y	Y	
	Drawers/Inner Doors	3/	6/-	N	N	
Others	Certification	CE ATEX	CE ATEX	CE ATEX	CE ATEX	
	Interior Material/Colour	/	PS Plate/Grey	PCM	SUS	

Product appearance and specifications are subject to change without notice

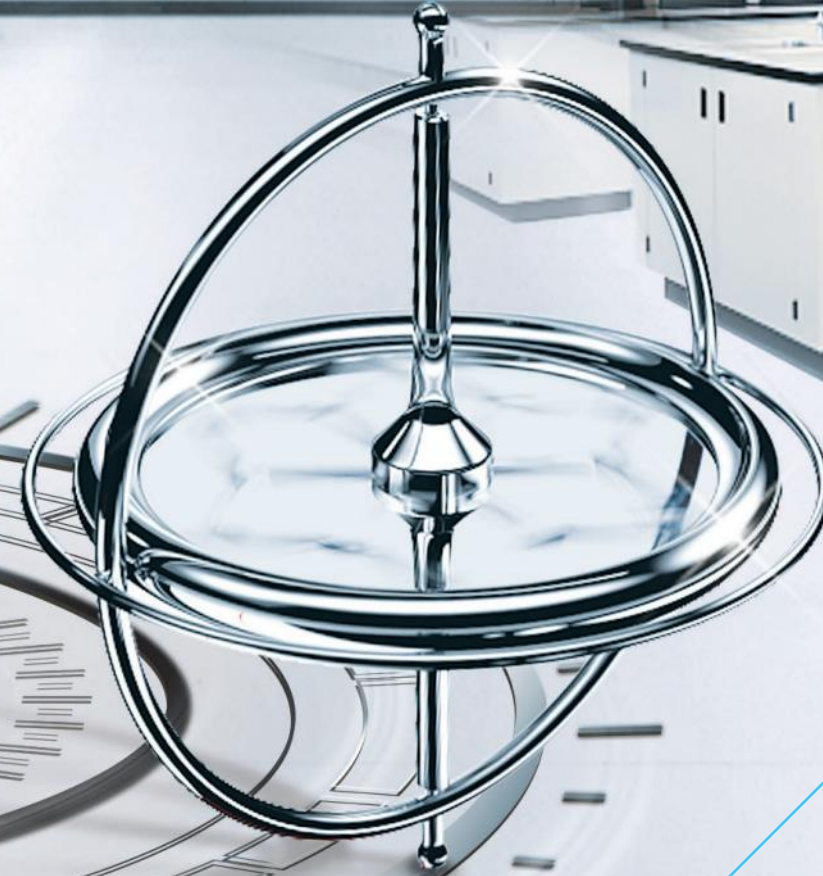

**Laboratory  
Refrigerator**



## Typical Installation

Used to store chemicals, reagents and consumables within laboratories and research facilities.

## Product Advantages

### Precise Control of Temperature

Adjustable set temperature range is 3°C to 16°C. A smart temperature control system keeps the internal temperature variation within  $\pm 3^\circ\text{C}$  inside the chamber.

### High Efficiency HC Cooling Technology

The hydrocarbon refrigeration system operates at a much higher efficiency and reduces the energy consumption by about 50 percent.

## Ergonomic Design

### One-touch search for historic data

The highest and lowest historic temperature data is saved and can be checked with one key stroke.

### Low Noise

Noise cancelling technology reduces the sound level to less than 40 dB(A) for an improved working environment.

### Automatic Door Closing Function



Cabinet Structure

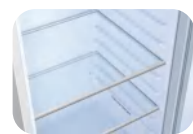

Glass Shelf



Fan/Interior Light



Display Board



### High Strength Glass Shelves

Tempered glass shelves hold 24kg of products per shelf.

### Dual lock design with multiple alarm systems

A mortise lock is standard on the door with option to add a padlock for additional security. Standard alarms include high and low temperature, door opening, and sensor errors.

## Specifications

	Model	HLR-310F	
Technical Data	Type	Upright	
	Climate Class	N	
	Cooling Type	Forced Air Cooling	
	Defrost Mode	Auto	
	Refrigerant	R600a	
	Sound Level (dB(A))	40	
Performance	Temperature Range (°C)	3-16 Adjustable	
	Ambient Temperature (°C)	16-32	
Control	Controller	Microprocessor	
	Display	LED	
Electrical Data	Power Supply (V/Hz)	220-240/50	
	Power (W)	225	
	Electrical Current (A)	1.6	
	Power Consumption (kWh/24h)	1.05	
Construction	Capacity (L/Cu.Ft)	310/10.9	
	Net/Gross Weight (approx)	kg	72/83
		lbs	158.7/183
	Interior Dimensions (W*D*H)	mm	560*500*1290
		in	22.0*19.7*50.8
	Exterior Dimensions (W*D*H)	mm	605*598*1840
		in	23.8*23.6*73.6
	Packing Dimensions (W*D*H)	mm	680*690*1940
in		26.8*27.1*74.4	
Loading Quantities	Container Load (20'/40'/40'H)	24/51/51	
Alarms	High/Low Temperature	Y	
	Sensor Error	Y	
	Door Ajar	Y	
Accessories	Caster	4	
	Foot	2	
	Porthole	Y	
	Shelves	4	
	Temperature Setting Mode	Password Protection	
Certification	Temperature Sensor	1 Resistance Thermometer	
	CE	Y	

Product appearance and specifications are subject to change without notice



# Fluid Warming Cabinet

145/146

## Application

Heating applications include warming of liquid medicine, nutrient solution, rinsing liquid and physiological saline. Installations can be found in operating rooms, ICU, emergency rooms, wards and other related areas.

## Product Features

- Fast heating speed: variable power PTC heating module with fast heating speed and energy saving.
- UV sterilization: UV light sterilization in the cabinet with a variety of optional sterilization methods for effective prevention of possible contamination.
- Multiple overheat protections: electronic control + mechanical temperature control + overheat protection, multiple temperature control to ensure heating safety.
- Environmentally friendly: no compressor or external fan, extremely quiet with no disturbance to the airflow in the operating room and no effect on temperature, reduces risks of cross-contamination.

## Product Advantages

- Fast and efficient heating.
- Standard UV sterilization for effective sterilization and other sterilization options available.
- Multiple over heating protections to ensure product viability.
- Two-sensor.

## Ergonomic Design

- Large and clear 7-inch LCD touch screen.
- Easy to clean stainless steel interior and flat external surfaces.
- Multiple alarms for over-heating protection.



Internal Structure



7 Inch LCD Screen



UV Sterilization Lamp

## Specifications

Model		HYR-111	
Technical Data	Cabinet Type	Upright, one glass door	
	Climate Class	SN	
	Warming Type	Forced air warming	
	Sound Level (dB(A))	42	
Performance	Temperature Range (°C)	26°C-50°C, above ambient temperature	
Control	Controller	Microprocessor	
	Display	LCD Touch Screen	
Electrical Data	Power Supply (V/Hz)	220/50	
	Power(W)	130	
	Power Consumption (kWh/24h)	0.59	
Construction	Capacity (L/Cu.Ft)	111/3.9	
	Net/Gross Weight (approx)	kg	58/68
		lbs	127.6/149.6
	Interior Dimensions (W*D*H)	mm	477*528*462
		in	18.67*20.67*18.1
	Exterior Dimensions (W*D*H)	mm	597*682*833
		in	23.37*26.7*32.61
Packing Dimensions (W*D*H)	mm	700*775*960	
	in	27.6*30.5*37.8	
Loading Quantities	Container load (20'/40'/40'H)	46/94/94	
Alarms	High/Low Temperature	Y	
	Sensor Error	Y	
	Door Ajar	Y	
Accessories	Caster	Y	
	Foot	Y	
	Porthole	Y	
	Shelves	Y	

Product appearance and specifications are subject to change without notice





Transportation



Temperature Range 0~25°C

Scope of Application

This product is applicable for international aviation cold chain transportation of drugs, vaccines, medicines, biological products, raw materials, high-end fresh food and other products which require strict temperature control.



Product Advantages

 Robust construction with advanced technology to ensure reliable quality and stable performance

 Prevent internal temperature deviation and ensure the temperature uniformity under extreme environmental temperature changes

 Superior internal temperature uniformity

 Cost-effective performance

Specifications

Model	RKN-AT1		
Power	Supports automatic switching between external AC power supply and built-in battery power supply, which is convenient to use and simple to operate		
	Recharging power supply	100-240V AC, 50-60Hz	
	Maximum charging time (h)	10 (fast charging)	
	Maximum power during charging (w)	1,100	
Temperature Control Performance	The temperature management system, developed independently, achieves accurate temperature control through compressor refrigeration and electric heating innovative air circulation system to effectively balance the temperature difference		
	Temperature range	0°C~+25°C (+32°F to +77°F)	
	Internal temperature tolerance	At set temperature +2°C~+10°C (+35.6°F to +50°F), Tolerance +/-3°C (+/-5.4°F) At set temperature +10°C~+20°C (+50°F to +68°F), Tolerance +/-5°C (+/-9°F)	
	Battery capacity	When the ambient temperature is 25°C (77°F), the set temperature is 5°C (41°F), the container can operate for more than 50 hrs.	
	Operating ambient temperature	-20°C~+43°C (-4°F to +109.4°F)	
	Storage ambient temperature	-40°C~+55°C (-40°F to +131°F)	
Construction	Internal effective volume	2m <sup>3</sup> (70.6 foot <sup>3</sup> )	
	Exterior dimensions (L*W*H)	mm	2005*1534*1620
		in	78.9*60.4*63.8
	Interior dimensions (L*W*H)	mm	1294*1273*1264
		in	50.9*50.1*49.8
	Door opening (L*H)	mm	1294*1264
in		50.9*49.8	
Weight	Tare weight	kg	650
		lbs	1433
	Operational maximum gross weight	kg	1588
		lbs	3500
	Maximum payload	kg	938
		lbs	2067
Data Recording	Data recording function: internal and external temperature, door opening times, alarm information through USB port		
Others	Applicable Aircraft Models: A300, A310, A330, A340, A380, B747, B767, B777, DC10, IL86, MD11, L1011 as key examples		
Note	Tare weight and maximum payload might vary due to load variations and maintenance		

Product appearance and specifications are subject to change without notice



Temperature Range 0~10°C

Active Cooling Solution



HZY-8Z/8ZA



HZY-15Z/15ZA

- Accurate control of the temperature between 2-6°C
- PCM ice raft
- Constant temperature range (4±1°C)
- Complete process with cold chain monitoring
- Replace the traditional insulation method with haier's transport cooler for transport
- Blood from blood transfusion department to clinical blood transfusion point



Low Noise

- The ultra-quiet fan is equipped with air outlets on both sides, noise level less than 34 dB providing a more comfortable environment.



Air Duct Structure



Easy to Clean

- The inner liner adopts aluminium oxidation process to make it smooth inside and easy to clean.



Internal Structure

Product Features

Semiconductor for active cooling, energy saving and environmental protection.

- Connect to power to cool unit to temperature, during transportation (without power) the unit will hold temperature. Small and easy to carry.

2-6 °C precise temperature control, suitable for storage of biological products such as blood, medicines and reagents etc.

- Temporary blood storage to ensure blood safety at clinical blood stations.

Embedded with 4 °C phase change PCM ice pack for cold storage, providing long insulation after power off to ensure blood safety during the transportation.



4 °C PCM Ice Pack

- The PCM ice pack uses a 4°C phase change material with a freezing point greater than 2°C to ensure the low temperature preservation of blood and other biological samples.
- At 25 °C under no load, the time for temperature inside the box rises to 10 °C is more than 1 hour.
- At 25 °C under full load, the time for temperature inside the box rises to 10 °C is more than 2 hour.

Multiple Fault Alarms, Making It Safer to Use.

- High/low temperature alarm, power failure alarm, and sensor error alarm.

The Power Supply Is Configured with Cigarette Lighter Plug, Easy for Vehicle Transportation.

- The power supply is configured to fit the vehicles internal power plug, easy for vehicle transportation.

Passive Cooling Solution

- Multi-function handle with casters for easy transportation
- Multi dimensional binding of orders and blood, and whole process with cold chain monitoring
- From blood collection vehicle/blood donation house to blood center/blood station from blood center/blood station to hospital

Product Features

- LCD screen, real-time display of inside temperature, battery level and other information.
- Electromagnetic lock as standard, ability to scan QR code to open the unit, safeguarding the stored items.
- 4°C ice pack ensures cool storage temperatures with zero freezing to keep blood within safe storage temperature guidelines during transportation.



HZY-5B



HZY-35B

Product Features

- Real-time display of inside temperature.
- Integrated cold storage ice pack box, easy to access ice pack.
- Rotational moulding shell, anti-knocking, easy to carry.
- Multifunctional handle, sided casters, easy to be transported on flat road.

## Specifications



	Model	HZY-5B	HZY-8Z	HZY-15Z
Technical Data	Storage Temperature (°C)	/	2-6	2-6
	Operating Temperature (°C)	2-10	2-10	2-10
Construction	Net / Gross Weight (kg)	2/3	3.5/5	6/8
	Exterior Dimensions (W*D*H mm)	2859*186*200	320*265*260	520*300*270
	Interior Dimensions (W*D*H mm)	220*118*126	230*140*170	430*150*180
	Packing Dimensions (W*D*H mm)	357*277*287	393*362*367	595*375*404
	Blood Bag Capacity	5	8	15
	Functions	Foam material	High density foam	Polyurethane Cycloisopentane
	Refrigeration method	Passive cooling	Semiconductor active refrigeration	Semiconductor active refrigeration
	Warm up time	3 hours (32°C ambient temperature load situation)	2 hours (32°C ambient temperature load situation)	2 hours (32°C ambient temperature load situation)
	Shell/liner	ABS/ABS	ABS/aluminium plate	ABS/aluminium plate
	Alarm	Low Battery	High temperature, sensor error, power off	High temperature, sensor error, power off
	Battery	Lithium Battery	Rechargeable lithium battery	Rechargeable lithium battery
Certification	CE	/	Y	Y

## Specifications



		HZY-8ZA	HZY-15ZA	HZY-35B
Technical Data	Storage Temperature (°C)	2-6	2-6	/
	Operating Temperature (°C)	2-10	2-10	2-10
Construction	Net / Gross Weight (kg)	4/5	6/8	9/12
	Exterior Dimensions (W*D*H mm)	320*265*260	520*300*270	550*328*370
	Interior Dimensions (W*D*H mm)	230*140*170	430*150*180	450*232*295
	Packing Dimensions (W*D*H mm)	393*362*367	595*375*404	674*455*490
	Blood Bag Capacity	8	15	35
Functions	Cold Chain Monitoring	Y	Y	/
	NFC Unlock	/	Y	/
	Foam material	Polyurethane Cycloisopentane	Polyurethane Cycloisopentane	Polyurethane Cycloisopentane
	Refrigeration method	Semiconductor active refrigeration	Semiconductor active refrigeration	Passive cooling
	Warm up time	2 hours (32°C ambient temperature load situation)	2 hours (32°C ambient temperature load situation)	6 hours (43°C ambient temperature load situation)
	Shell/liner	ABS/aluminium plate	ABS/aluminium plate	HDPE/HDPE
	Alarm	High temperature, sensor error, power off	High temperature, sensor error, power off	/
	Battery	Rechargeable lithium battery	Rechargeable lithium battery	Button battery
Certification	CE	/	/	Y

Product appearance and specifications are subject to change without notice

# Transport Cooler for Infectious Products

The virus is high-risk specimen, and if there is a collision during the transportation or transmission, there will be a risk of leakage and re-infection. A solution is urgently needed to ensure the viability of the samples and the safety of transport personnel.

## Packaging System

### Three-layer packaging:

- **Main container**  
Test tube with cap (user configures according to business)
- **Auxiliary container**  
≥95kPa pressure sealed tank (EPS or EPE bracket for fixing test tube, 16 hole D10 test tube and 2 hole D15 test tube)
- **Outer packaging**  
Transfer box (ice row, foam used to fix sealed container, activated carbon and other adsorbed substances, sample labeling)

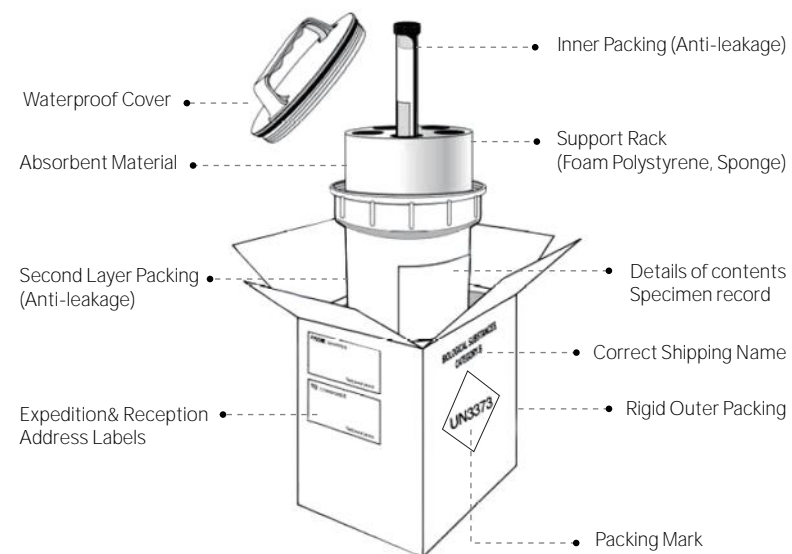

## Active Cooling



HZY-8Z (Specimen)



HZY-15Z (Specimen)

## Product Advantages



### Active semiconductor cooling, energy saving and environment friendly

Active semiconductor cooling, energy saving and environmental protection, built-in cooling function, cooling after power on.



### Precise temperature control

Precise temperature control at 2°C-6°C is suitable for the temporary storage of biological products such as serum and blood specimens.



### Built-in, 4°C phase change PCM, ice row cooling, long-term insulation after power failure, to ensure the safety of specimen

Under the condition of no load at 25°C, the temperature of the air in the box rising to 10°C takes 1 hour; under the loading condition of 25°C, the air temperature in the box rising to 10°C takes 2 hours.



### Multiple fault alarms, safer to use

High and low temperature alarm, power failure alarm, sensor error alarm.



### The power supply is equipped with a car cigarette lighter plug, which is convenient for vehicle transport

The power supply can support 12V and 100-240V conversion, so the container can be put into the car to plug in and transfer.

## Auxiliary Container



HZY-8Z (Specimen)



HZY-15Z (Specimen)



### Pressure sealed tank (EPS or EPE holder for fixing test tubes, 16-hole D10 test tube and 2-hole D15 test tube)

The pressure-sealed tank remains intact at the temperature of the refrigerant used, as well as the temperature and pressure that may occur after loss of refrigeration. Under the condition of no leakage, it can withstand the internal pressure of 95kPa, and can ensure that it will not be damaged in the temperature range of -40°C to +55°C.



## Transport Cooler for Infectious Products

157/158

Passive Cooling UN2814 transport cooler  
HZY-10B (P620)

## Product Advantages

**Passive cooling, long heat preservation time, suitable for air transportation;**

At 32°C ambient temperature, the temperature inside the box (pre-cooled in advance) rising to 10°C takes 8 hours (P620).

**PCM ice row, frozen at 4°C, to ensure the safety of specimen storage;**

The shell is made of aluminum-magnesium alloy, with high strength; Meeting the P620 packaging requirements of Class A infectious substances(HZY-10B).

Auxiliary Container 

HZY-10B (P620)

**Pressure sealed tank (EPS or EPE holder for fixing test tubes, 16-hole D10 test tube and 2-hole D15 test tube)**

The pressure-sealed tank remains intact at the temperature of the refrigerant used, as well as the temperature and pressure that may occur after loss of refrigeration. Under the condition of no leakage, it can withstand the internal pressure of 95kPa, and can ensure that it will not be damaged in the temperature range of -40°C to +55°C.

## Specifications

Model	HZY-8Z	HZY-15Z
Use	Transfer of biological specimens, etc	Transfer of biological specimens, etc
Type	Active cooling, portable	Active cooling, portable
Internal dimensions (W*D*H mm)	230*140*170	430*150*180
External dimensions (W*D*H mm)	320*265*260	520*300*270
Loading quantity	1 transport tank	2 transport tanks
Effective volume	6L, 1 built-in specimen seal can	12L, 2 built-in specimen seal cans
Specimen seal can dimension (mm)	H160*D130	H160*D130
Tube storage capacity	16 pcs D10 test tubes (small), 2 pcs D15 test tubes (large)	
Net weight (kg)	3.5	6
Controller	Microprocessor control	Microprocessor control
Temporary storage temperature (°C)	2-6	2-6
Transfer temperature (°C)	2-10	2-10
Holdover time (25°C, no load) (h)	1	1
Holdover time (25°C, full load) (h)	2	2
External material	ABS, high-density EPS foam filling	ABS, high-density EPS foam filling
Internal material	Aluminum plate	Aluminum plate
Door material	ABS, high-density EPS foam filling	ABS, high-density EPS foam filling
Cold storage	PCM ice-pack for cold storage	PCM ice-pack for cold storage
Cooling type	Optimized semiconductor cooling	Optimized semiconductor cooling
Cooling fan	ADDA fan	ADDA fan
Temperature control and display	Microprocessor control, dual sensors for control and display, display accuracy 0.1 °C	
Alarms	Sensor failure alarm, high temperature alarm, power failure alarm	

## Specifications

Model	HZY-10B (P620)
Purpose	Disease control centers, hospitals, etc. are used for transport of infectious substance specimens (air transportation)
Type	Passive cooling
Internal dimensions (W*D*H mm)	345*225*182
External dimensions (W* D* H mm)	430*312*272
Loading quantity	2 transport tanks
Effective volume	14L with 2 built-in specimen sealed tanks
Specimen sealed tank size (mm)	H160*D130
Number of test tubes (Single tank)	16 test tubes D10 (small), 2 test tubes D15 (large)
Net weight (kg)	8
Transport temperature (°C)	2-10
Thermal insulation time (32°C full load) (h)	8
Cabinet material	Aluminum magnesium alloy box shell
Thermal insulation material	EPP foam liner
Cool storage mode	PCM ice pack cold storage

# Vaccine Transport Cooler

159/160



The vaccine transport cooler is superior and efficient, having dual capabilities for cold storage and temperature preservation, which is environmentally friendly and energy saving. The performance of the cooler and holdover time of temperature preservation is influenced by the temperature of the stored items.

6 Liter/12 Liter/20 Liter/ 30 Liter

**Scope of Application** ▶ Suitable for vaccine cold chain transportation.

## Product Design and Advantages

- Both inside and outside of the boxes are made of PP (high strength plastic) material, non-toxic and harmless, safe for direct food contact.
- The wall of the box is filled with fluorine-free polyurethane foam insulation material without adding any chemical material, environment-friendly and odor-free.
- The body of the unit is designed with handles on both sides to facilitate manual handling & is manufactured with anti-ultraviolet materials.
- Equipped with professional sealing ring design, with good heat insulation and refrigeration effect.

## Specifications



Model	QBLL0606	QBLL0812	QBLL0820	QBLL0830
Temperature Range (°C)	2-8	2-8	2-8	2-8
Volume (L)	6	12	20	30
Exterior Dimension (mm)	330*240*275	420*245*300	440*262*308	580*310*360
Interior Dimension (mm)	238*143*195	335*170*240	375*215*250	475*245*295
Net Weight (Kg)	1.8	2.4	3.5	4.5
Material	PP	PP	PP	PP
Cold Source Configuration	6 pieces QB004 ice boxes	6 pieces QB004 ice boxes	10 pieces QB004 ice boxes	6 pieces QB010 ice boxes

Remark: QB004 and QB010 are models of ice packs, the dimension of QB004 is 160\*90\*30mm and the dimension of QB010 is 280\*120\*30mm



High strength material, anti-collision, non-toxic and harmless, UV resistant.



The outer-unit body is equipped with an integrated handle, which is firmly installed and durable.



Real-time display of temperature inside the cooler, making the temperature monitoring more intuitive.



Specially positioned ice packs, partitioned storage, easy to operate.



Professional & innovative sealed design ensuring zero cold leakage to achieve safe, secure and reliable long-term cooling preservation.

## Typical Application

Cold chain transportation for samples, reagents, blood products, specimens and drugs.

## Specifications







Model	FS-12LS	FS-18LS	FS-35LS	FS-54LS	FS-100L	FS-110L
Temperature Range (°C)	0-10	0-10	0-10	0-10	0-10	0-10
Duration (h)	≥24	≥24	≥24	≥24	≥24	≥24
Exterior Dimensions (W*D*H)(mm)	440*262*308	440*262*308	570*305*365	615*395*450	680*500*540	832*515*524
Interior Dimensions (W*D*H)(mm)	325*170*225	363*203*244	475*245*270	520*310*355	580*400*440	732*421*425
Qty of Icepacks (Pcs)	4	4	4	4	4	6
Net Weight (kg)	6.2	6.5	9.5	18.5	22	19

Note: -25--15°C and 15-25°C are available with optional ice packs. The standard ice packs can only achieve 0-10°C temperature storage.

Temperature Range -20~10°C







ALG50

-  Low voltage battery protection
-  LED lighting
-  Widescreen LCD display
-  Real-time voltage display
-  Detachable temperature sensor
-  Standard basket







BCD60

-  Low voltage battery protection
-  LED lighting
-  Detachable temperature sensor
-  Widescreen LCD display
-  Real-time voltage display



BCD115

-  Low voltage battery protection
-  LED lighting
-  Detachable temperature sensor
-  Widescreen LCD display
-  Real-time voltage display

Specifications

Model	ALG50	BCD60	BCD115
Capacity (L)	50	60	115
Climate Type	T, ST, SN, N	T, ST, SN, N	T, ST, SN, N
Net Weight (Kg)	16.7	24.0	28.6
Operating Temperature (°C)	-20~ +10 (at 25°C)	-18~ +10 (at 32°C)	-18~ +10 (at 32°C)
Power (W)	55	70	70
Refrigerant	R134a	R134a	R134a
Insulation Material	C5H10/C-Pentane	C5H10/C-Pentane	C5H10/C-Pentane
Exterior Dimensions (W*D*H) mm	630*404*530	621*485*569	811*482*672
Packing Dimensions (W*D*H) mm	715*450*625	718*578*638	906*575*745
Voltage Power Supply	AC110-240V, 50/60Hz	AC110-240V, 50/60Hz	AC110-240V, 50/60Hz
	DC 12V/24V	DC 12V/24V	DC 12V/24V
Power Consumption (kWh/24h)	0.23	0.25	0.25



### Scope of Application

Cold chain transportation of samples, reagents, blood products, specimens and pharmaceuticals.



### Product Advantages

- One unit for multiple applications**  
The power supply is equipped with a car cigarette lighter plug, AC 100-240V adapter and optional pluggable lithium battery, which is convenient for vehicle transport, long-term storage at home and outdoors use
- Low sound level**  
Noise level less than 45 dB, providing a more comfortable environment
- Anti-shake design**  
No fear of bumps
- Low voltage battery protection**  
During vehicle use automatically detect battery power and power-off when the battery voltage is low to protect automobile battery
- Double door double control series**  
Double chamber, but independent temperature control. Both compartment can be adjusted as a fridge or a freezer
- Bluetooth connectivity (optional)**  
APP Bluetooth intelligent connection

### Product Details

- USB charging port**  
It can charge electronic devices such as mobile phones
- Embossed aluminum liner**  
Stable performance and rapid refrigeration
- Design of portable pull rod for air circulation**  
Longer pull rod, won't touch the heel
- Double door design**  
Reversible door installation, dual door opening direction
- Two LED lights**  
Light up immediately after opening, convenient for taking things at night
- Outlet**  
It is convenient to clean the refrigerator and drain dirty water
- Door body groove**  
Can hold mobile phones, iPads, etc
- Optional Bluetooth app**  
Remote temperature control, breaking the distance constraint

### Product Dimension Drawings

Model	Serial No.	A1/mm	B1/mm	C1/mm	A2/mm	B2/mm	C2/mm
WEG45		232	314	340	232	314	160
WEG55		232	314	424	232	314	244
WEG65		232	314	494	232	314	314

### Specifications

Model	WEG45	WEG55	WEG65
Exterior Dimensions (mm)	750*449*455	750*449*525	750*449*595
Packing Dimensions (mm)	780*500*515	780*500*585	780*500*655
Net Weight (Kg)	16.5	17.5	18.5
Gross Weight (Kg)	19.5	20.5	21.5
Container Load (20')	136	136	102
Container Load (40'H)	360	288	288
Volume (L)	38 (Large: 25, Small: 13)	48 (Large: 30, Small: 18)	58 (Large: 35, Small: 23)
Ambient Temp. (°C)	10°C - +43 (SN/N/ST/T)	10°C - +43°C (SN/N/ST/T)	10°C - +43°C (SN/N/ST/T)
Cooling Type	Compressor	Compressor	Compressor
Refrigerant	R134a/50±0.5g	R134a/50±0.5g	R134a/60±0.5g
Thickness of Foaming Layer (mm)	45	45	45
Foaming Material	C5H10/C-Pentane	C5H10/C-Pentane	C5H10/C-Pentane
Temp. Range	-20°C - +10°C (@25°C)	-20°C - +10°C (@25°C)	-20°C - +10°C (@25°C)
Voltage (V)	DC 12/24	DC 12/24	DC 12/24
Power of Adapter (V/Hz)	AC110-240, 50/60	AC110-240, 50/60	AC110-240, 50/60
Rated Power (W)	60	60	60
Noise Level (dB)	≤45	≤45	≤45
Working Mode	Direct cooling	Direct cooling	Direct cooling
Material of Shell	HDPE+PP	HDPE+PP	HDPE+PP
Power Consumption (kWh/24h)	0.23	0.23	0.23
Optional-Lithium Battery	187kwh,13000mAh	187kwh,13000mAh	187kwh,13000mAh
QTY of Blood Bags	Big space 48U	Small space 24U	Big space 72U
Dimension of Blood Bag: 140*110*25 (mm)			Small space 36U
			Big space 72U
			Small space 48U

\*Haier Biomedical reserves the right to change products and specifications without prior notice.

## Active Cooling

### Product Advantages

#### DC Frequency Conversion Technology

DC frequency conversion compressor, superior energy efficiency.

#### Tilt Protection Function

Electronic gyroscope in board, effective protection for compressors.

#### Integrated Main Body

Rotational molding body better adapted to complex transport environments.

#### Multiple Power Supply

Supports AC and DC power.



HZY-40Z

### Unique Designs

-  The body and door use integrated roto molding.
-  Using environmental LBA CFC-free foaming materials, thermal insulation performance is increased by up to 5%.
-  The body is equipped with a handle for easy carry.
-  Optional: Casters to facilitate transport.
-  Optional: Electromagnetic lock, with password lock equipped; more secure.
-  Forced air cooling method, the temperature is more uniform.
-  Built-in UVC ultraviolet lamp for regular disinfection.
-  3 in 1 wide temperature range, multiple functions within one unit, greater cost savings.

### Specifications

Model	Exterior Dimension (W*D*H)(mm)	Interior Dimension (W*D*H)(mm)	Capacity (L)	Door	Foam Materials	Compressor	Basket Load Bearing(KG)	Working Mode	Outer Shell/ Inner Liner	Condenser/ Evaporator
HZY-40Z	800*550*505	338*348*285	33	Rotational moulding integrated forming foam door	LBA	DC variable frequency compressor	≤35	Forced air cooling and heating	Rotational moulding	Microchannel/ Fin type

Controller	Refrigerant	Light	UV Lamp	Net Weight (KG)	Temperature Range (°C)	Power Supply	Max power (W)	Power Consumption (Kwh/24h)	Electro-magnetic Lock	USB
Microprocessor	HFC	LED 1W	UVC 1W	42	-20 to 22	AC 110-240V 50/60Hz DC12/24V	90	1.5	Optional coded lock	Optional

## Insulated Container







Temperature Range -25~25°C



### Scope of Application

Cold chain transportation of biological agents, blood products, specimens, medicines and fresh food.

### Product Advantages

-  Detachable insulation board, easy for recovery, low salvage cost
-  Special ice pack support for refrigerant box
-  Special forklift base, convenient for loading and unloading goods
-  Special insulation material, temperature inside last longer
-  Optional temperature recorder, temperature monitoring is more intuitive
-  Customized size



### Typical Performance Characteristics

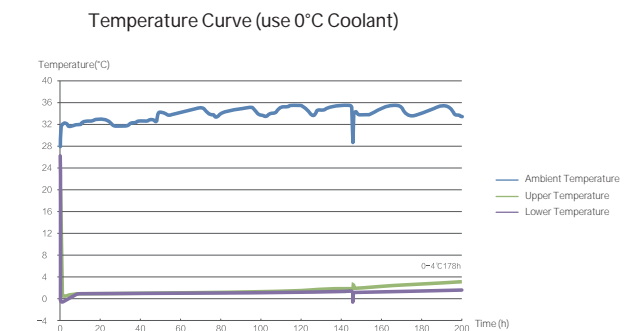

### Specifications

Model	Net Weight (KG)	Exterior Dimensions (W*D*H)(mm)	Interior Dimensions (W*D*H)(mm)	Temperature Range (°C)	Holdover Time (h)
VPU-1000L	144	1220*1140*1140	1020*940*1020	0-10	178

Product Advantages

**Check the insulation status at any time**  
Real-time upload setting parameters, operation parameters, operation curve, alarm record and event record. Monitor the operation of the transport cooler through the UCool system to visualize the complete process and traceability of information.

**Stable performance, long service life**  
The product adopts VIP insulation technology which has an insulation performance of 5-8 times that of polyurethane foam, and significant extended time temperature control that handles the changing transportation conditions and environment; It has long service life by adopting nanometer core material.

**Light weight, easy to carry**  
Lightweight with ergonomic design is easy to carry.

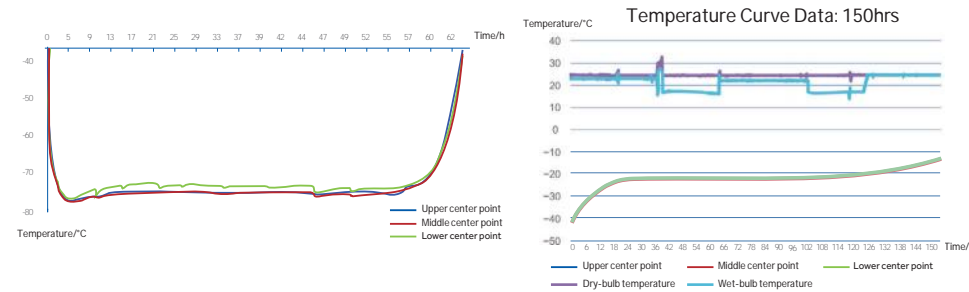
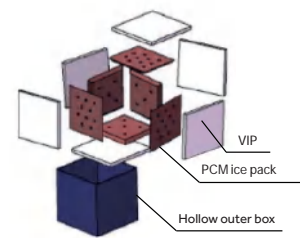

Specifications

Model	BW25-8A	BW25-12A	BW50-12A	BW25-18A	BW25-36A	BW50-36A	BW25-64A
Temperature Range (°C)	-25~-15/2-8/ 15-25/-90~-60	-25~-15/2-8/ 15-25/-90~-60	-25~-15/2-8/ 15-25/-90~-60	-25~-15/2-8/ 15-25/-90~-60	-25~-15/2-8/ 15-25/-90~-60	-25~-15/2-8/ 15-25/-90~-60	-25~-15/2-8/ 15-25/-90~-60
Exterior Dimensions (W*D*H)(mm)	455*295*295	410*345*355	470*400*410	510*350*355	515*450*460	575*510*510	590*525*525
Packing Dimensions (W*D*H)(mm)	546*381*389	504*436*444	560*492*500	607*439*447	609*541*549	665*597*605	679*611*619
Interior Net Dimensions (W*D*H)(mm)	310*215*215	270*270*270	270*270*270	370*270*270	370*370*370	370*370*370	440*440*440
Payload Size (with ice pack)(mm)	270*175*175 (8L)	230*230*230 (12L)	230*230*230 (12L)	330*230*230 (18L)	330*330*330 (36L)	330*330*330 (36L)	400*400*400 (64L)
Net Weight (kg)	4	4.8	9.8	5.6	8.2	16.4	11
Gross Weight (kg)	6	6.8	12.5	8.2	11.2	20	14.8
Recorder Monitoring	Optional	Optional	Optional	Optional	Optional	Optional	Optional
Heat Insulating Material	VIP	VIP	VIP	VIP	VIP	VIP	VIP
Insulation Thickness (mm)	25	25	50	25	25	50	25
Daily Consumption of Dry Ice (kg)	1.5	1.6	0.75	1.85	2.5	1.5	2.7
Safety Margin (kg)	1	1	1	1	2	2	2

Note: The safety margin is the minimum amount of dry ice required to keep the temperature in the box not higher than -70°C.

Moderna Vaccine Transport Solutions (-25 to -15°C)

(Size:5.5"L\*2.2"W\*2.5"H)

Model	BW25-8A	BW25-12A	BW50-12A	BW25-18A	BW25-36A	BW50-36A	BW25-64A	HZY-40Z
Refrigeration Principle	PCM	PCM	PCM	PCM	PCM	PCM	PCM	Compressor
Temperature Range (°C)	-25~-15	-25~-15	-25~-15	-25~-15	-25~-15	-25~-15	-25~-15	-20~-15
External Size (mm)	455*295*295	410*345*355	470*400*410	510*350*355	515*450*460	575*510*510	590*525*525	800*550*505
Payload Size (mm)	270*175*175	230*230*230	230*230*230	330*230*230	330*330*330	330*330*330	400*400*400	377*348*285
Gross weight (kg)	6	6.8	12.5	8.2	11.2	20	14.8	61
Hold Over Time (h)	56h	48h	120h	68h	70h	150h	86h	6h
Qty of Moderna Vaccine (CAR)	10	16	16	28	56	56	114	58
Qty of Moderna Vaccine (Vials)	100	160	160	280	560	560	1140	580
Qty of Moderna Vaccine (Doses)	1000	1600	1600	2800	5600	5600	11400	5800

AstraZeneca Vaccine Transport Solutions (2 to 8°C)

(Size:135mmL\*56mm"W\*60mm"H)

Model	BW25-8A	BW25-12A	BW50-12A	BW25-18A	BW25-36A	BW50-36A	BW25-64A	HZY-40Z
Refrigeration Principle	PCM	PCM	PCM	PCM	PCM	PCM	PCM	Compressor
Temperature Range (°C)	2-8	2-8	2-8	2-8	2-8	2-8	2-8	2-8
External Size (mm)	455*295*295	410*345*355	470*400*410	510*350*355	515*450*460	575*510*510	590*525*525	800*550*505
Payload Size (mm)	270*175*175	230*230*230	230*230*230	330*230*230	330*330*330	330*330*330	400*400*400	377*348*285
Gross weight (kg)	6	6.8	12.5	8.2	11.2	20	14.8	61
Hold Over Time (h)	60h	50h	130h	72h	72h	168h	96h	6h
Qty of Moderna Vaccine (CAR)	10	16	16	28	56	56	114	58
Qty of Moderna Vaccine (Vials)	100	160	160	280	560	560	1140	580
Qty of Moderna Vaccine (Doses)	1000	1600	1600	2800	5600	5600	11400	5800

Chinese COVID-19 Vaccine Transport Solutions (2 to 8°C)

Model	BW25-8A	BW25-12A	BW50-12A	BW25-18A	BW25-36A	BW50-36A	BW25-64A	HZY-40Z
Refrigeration Principle	PPCM	PCM	PCM	PCM	PCM	PCM	PCM	Compressor
Temperature Range (°C)	2-8	2-8	2-8	2-8	2-8	2-8	2-8	2-8
External Size (mm)	455*295*295	410*345*355	470*400*410	510*350*355	515*450*460	575*510*510	590*525*525	800*550*505
Payload Size (mm)	270*175*175	230*230*230	230*230*230	330*230*230	330*330*330	330*330*330	400*400*400	377*348*285
Gross weight (kg)	6	6.8	12.5	8.2	11.2	20	14.8	61
Hold Over Time (h)	60h	50h	130h	72h	72h	168h	96h	6h
Qty of SinoVac Vaccine (Doses)	60	60	60	128	280	280	400	240
Qty of CNBG Vaccine (Doses)	68	110	110	154	315	315	618	240





Pharmacy  
Refrigerator







# New Generation Pharmacy Refrigerator

Used for storage of medicines, vaccines, reagents, biological products and other items that require a temperature between 2-8°C in hospitals, pharmacies, pharmaceutical factories, clinics and laboratories as key examples.

## Product Advantages

 Ergonomic & innovative design, 7" touch screen, easy to check the cabinet temperature, alarm & event records; authority management is standard to avoid unauthorized access or change in settings

 Triple-paned tempered glass door with frame heater to reduce condensation even at 32 ° C, 80% RH ambient; self-closing door with 90 ° stop; magnetic gaskets to ensure a positive seal

 Multiple alarm functions for safer monitoring, audible/visual alert with mute function; remote alarm contact is equipped as standard

 Anti-freezing thermostat is available to protect store items from freezing, which is DIN13277 compliance

 Energy efficient interior LED lighting, side-mounted for complete clear visibility of the internal area

 Standard USB module to easily record and export cabinet temperature and alarm data; Standard RS485 port and remote alarm contact for ease of external connection; optional printer to efficiently export cabinet temp data

 Microprocessor controller, smart inverter compressor, optimized air-cooling technology with auto defrost to ensure excellent cooling performance, defrost water to evaporate automatically



 Two 25mm probe access ports on each side wall to accept user-provided monitoring equipment

 Adjustable plastic-coated wire shelves for improved circulation and flexible storage, 4 swivel casters with 2 leveling feet for easy movement and fixing

 Electromagnetic lock is standard to avoid unauthorized access



HYC-1030GT



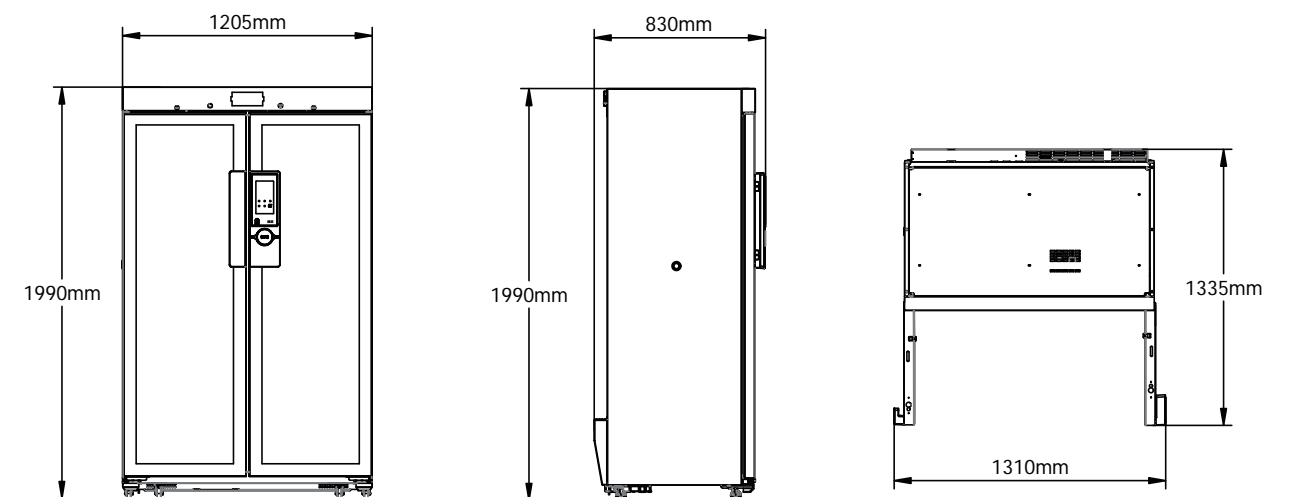





## Cabinet Temperature





# New Generation Pharmacy Refrigerator

Used for storage of medicines, vaccines, reagents, biological products and other items that require a temperature between 2-8°C in hospitals, pharmacies, pharmaceutical factories, clinics and laboratories etc.

## Product Advantages

-  Low energy consumption: 2.5 kWh/day<sup>①</sup>
-  Excellent performance: temperature uniformity  $\leq \pm 1^\circ\text{C}$ <sup>②</sup>
-  Quiet operation: 39dB (A)
-  Intelligent anti-condensation: triple-paned tempered glass door with door frame heater, effectively reduces condensation even at 32°C, 80% RH ambient temperature
-  Optional USB, RS485 and printer, easy to export temperature data; all events and alarms will be recorded by the USB module
-  Eco-friendly hydrocarbon refrigerant (R290) and CFC-free polyurethane insulation for reduced global warming
-  Hermetically sealed compressor, forced-air circulation and automatic defrost to ensure high cooling performance
-  Microprocessor controller, display with resolution of 0.1°C



-  Self-closing door with magnetic gasket for positive seal
-  Multiple alarm functions for safer monitoring

\* ①&②: Tested by TUV according to DIN13277



## Cabinet Temperature

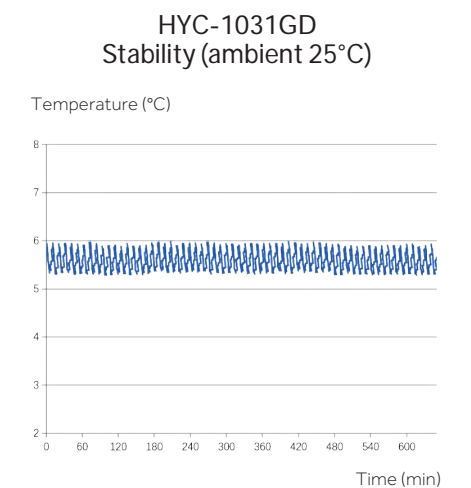
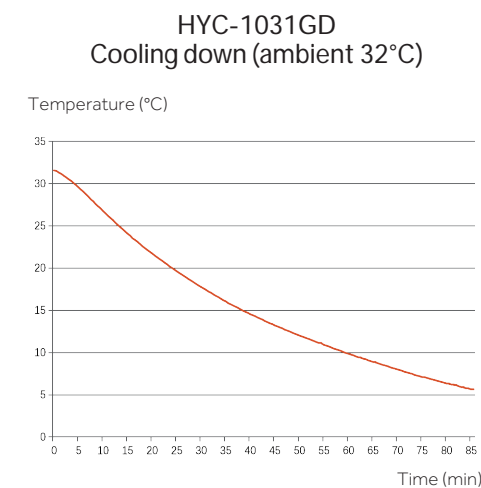





# New Generation Pharmacy Refrigerator

175/176

Used for storage of medicines, vaccines, reagents, biological products and other items that require a temperature between 2-8° C in hospitals, pharmacies, pharmaceutical factories, clinics and laboratories etc.

## Product Advantages

 Eco-friendly hydrocarbon refrigerant (R600a) and CFC- free polyurethane insulation for reduced global warming potential

 Hermetically sealed compressor, forced-air circulation with auto defrost to ensure superior cooling performance, temperature uniformity  $\leq \pm 1.5^{\circ}\text{C}$ ; and a anti-freezing thermostat is available to protect store items from freezing

 Triple-paned tempered glass door with frame heater to reduce condensation even at 32° C, 80% RH ambient; self-closing door hinge; magnetic gaskets to ensure a positive seal

 Energy efficient interior LED lighting, side-mounted to enlighten full space

 Optional USB module to easily record and export cabinet temperature and alarm data; optional RS485 port for effortless external connection; and optional printer to export cabinet temperature data





 A  $\phi$  25mm probe access port is standard on side wall to accept user-provided monitoring equipment

 4 swivel casters with 2 leveling feet for easy movement and fixing

 Multiple alarm functions for safer monitoring, audible/visual alert with mute function; remote alarm contact is equipped as standard

 Microprocessor controller, digital display with 0.1° C resolution; easy to check the min/max temperature in the past 24 hours; password protect function is available to avoid unauthorized setting.

 Convenient security with a top-mounted unique-key lock

 Adjustable plastic-coated wire shelves for improved circulation and flexible storage

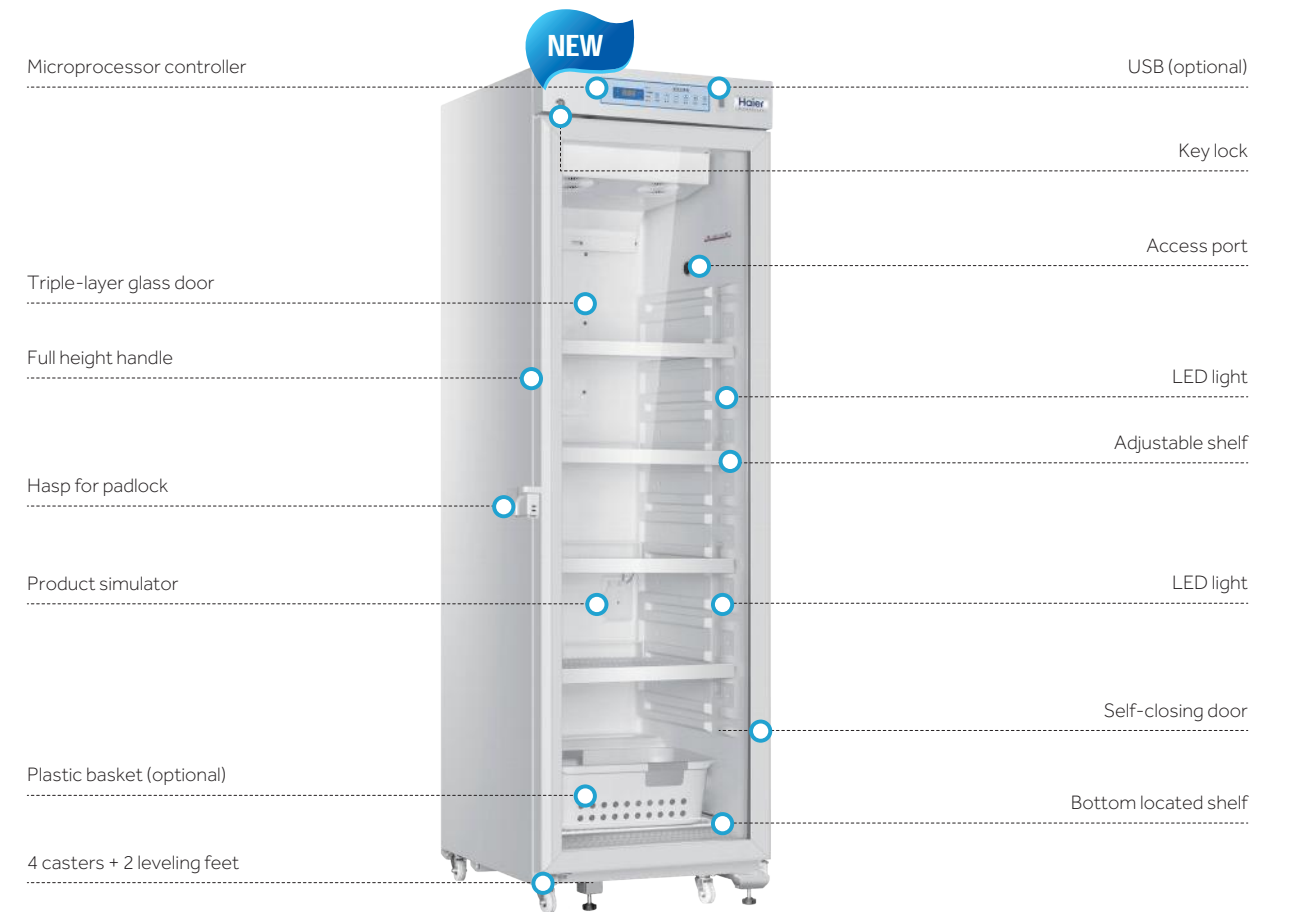









**HYC-461GD**

# New Generation Pharmacy Refrigerator



177/178

Used for storage of medicines, vaccines, reagents, biological products and other items that require a temperature between 2-8°C in hospitals, pharmacies, pharmaceutical factories, clinics and laboratories etc.

## Product Advantages

-  User reversible door hinge
-  Excellent performance: temperature uniformity  $\leq \pm 1^\circ\text{C}$  ①
-  Quiet operation: 35dB (A)
-  Intelligent anti-condensation: triple-paned tempered glass door with door frame heater, effectively reduces condensation even at 32°C, 80% RH ambient temperature
-  Optional USB and RS485, easy to export temperature data
-  Eco-friendly hydrocarbon refrigerant (R600a) and CFC-free polyurethane insulation for reduced global warming
-  Hermetically sealed compressor, forced-air circulation and automatic defrost to ensure high cooling performance
-  Microprocessor controller, display with resolution of 0.1°C



-  Magnetic gasket for positive seal
-  Multiple alarms for safer monitoring

\* ① Tested by TUV according to DIN13277

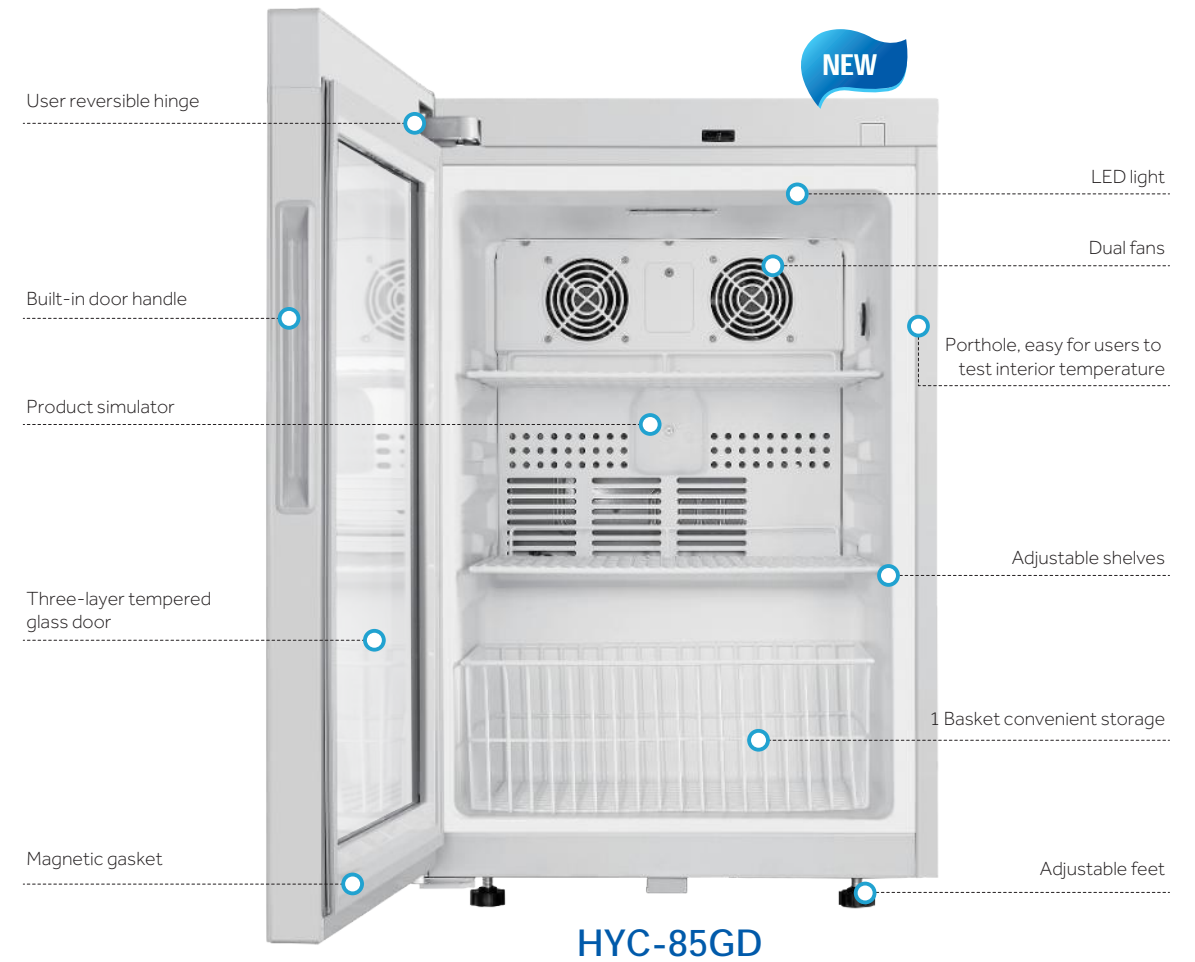

## Cabinet Temperature

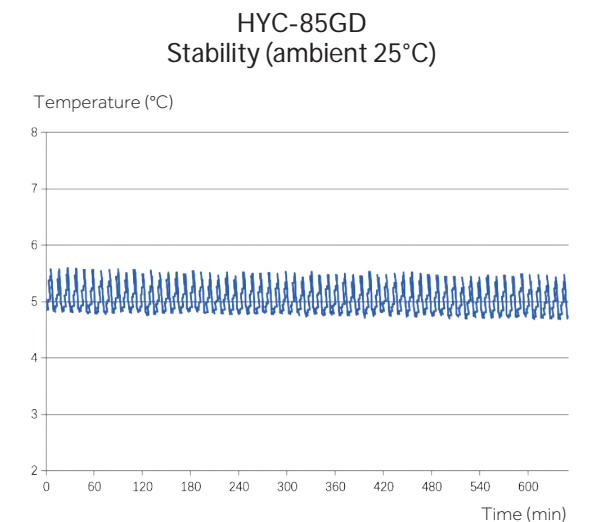
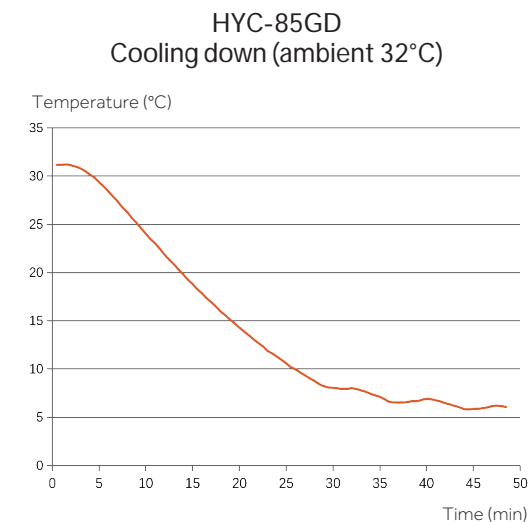

## New Generation Pharmacy Refrigerator

179/180

## Specifications

Model	HYC-1030GT		HYC-1031GD		HYC-461GD		HYC-85GD			
Technical Data	Cabinet Type	Upright, glass door		Upright		Upright, glass door		Table-top/Under-counter		
	Climate Class	N, 16-32°C		N, 16-32°C		N, 16-32°C		N, 16-32°C		
	Cooling Type	Forced air cooling		Forced Air Circulation		Forced air cooling		Forced Air Circulation		
	Defrost Mode	Auto		Auto Defrost		Auto		Auto Defrost		
	Refrigerant	R600a		R290, 80g		R600		R600a		
	Sound Level (dB(A))	37		39		37		35		
Performance	Temperature Range (°C)	2-8		2-8		2-8		2-8		
Control	Controller	Microprocessor		Microprocessor		Microprocessor		Microprocessor		
	Display	LED		LED		LED		Digital		
Electrical Data	Power Supply (V/Hz)	220-240/50/60		220-240: 50/60		220-240/50		220-240/50		
	Electrical Current (A)	450W / 2.2		2.2		1.7		0.98		
Dimensions	Capacity (L/Cu.Ft)	1030 / 36.4		1031/36.4		461/16.3		85		
	Net/Gross Weight (approx)	kg	265/275		255/265		115/125		36/41	
		lbs	584/606		562/584		254/276		/	
	Interior Dimensions (W*D*H)	mm	1115*590*1670		1115*590*1670		500*590*1670		405*405*555	
		in	43.9*23.2*65.7		43.9*23.2*65.7		19.7*23.2*65.7		/	
	Exterior Dimensions (W*D*H)	mm	1205*830*1990		1205*800*1990		595*800*1990		495*550*740	
		in	47.4*29.9*78.3		47.4*31.5*78.3		23.4*28.7*78.3		/	
	PackingDimensions (W*D*H)	mm	1260*905*2110		1260*905*2110		700*910*2080		590*650*830	
in		49.6*35.6*83.1		49.6*35.6*83.1		27.6*35.8*81.9		23.2*25.6*32.7		
	Container Load (20'/40'/40'H)	10/22/22		10/21/21		20/43/43		54/120/180		
Alarms	High/Low Temperature	Y		Y		Y		Y		
	Remote Alarm	/		Y		Y		Y		
	Power Failure	Y		Y		Y		Y		
	Sensor Error	Y		Y		Y		Y		
	Low Battery	Y		Y		Y		Y		
	Door Ajar	Y		Y		Y		Y		
Accessories	Caster	4		4		4		/		
	Foot	2		2		2		2		
	Porthole	2		2		1		1		
	Shelves/Drawers	12 adjustable + 2 bottom located		12/-		5 adjustable + 1 bottom located		2/1		
	USB Interface	Standard		Optional		Optional		Optional		
	Printer	Optional		Optional		Optional		N/A		
	Temperature Recorder	/		/		/		/		
Others	Certification	CE, DIN13277 (optional)		CE, DIN13277 (Optional)		CE, DIN13277 (optional)		CE, DIN13277 (Optional)		

\*Haier Biomedical reserves the right to change products and specifications without prior notice.



### Smart Management of Medicine and Reagents Starts with IoT Technology

Perform statistical analysis of market data and medicine or reagents usage to report on market trends providing highly useful feedback to production and sales.



HYC-509R



#### Smart IoT System Makes Storage Management Simple, Precise and Effective

RFID based smart IoT management system permits automatic management of stored products are automatically



Smart RFID label

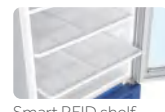

Smart RFID shelf



Industrial-grade IoT Network Module Group



#### Authorized Management for Material Flow at Controllable Risk

NFC authorized management system is traceable.



#### Statistical Analysis of Test Data, Precise Verification and Scientific Instruction

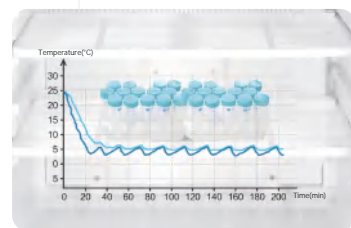

#### Precise Temperature Control Ultimate Safety of Test Reagents

2°C - 8°C storage temperature, real-time monitoring of cabinet temperature



#### Intelligent Accurate Recording

Intelligent touch screen for quick check of warehouse in-and-out records



#### Manage Market Data to Support Scientific Production Scheduling

Perform statistical analysis of market data and medicine or reagents usage to report on market trends providing highly useful feedback to production and sales.



#### Effective Management of Sales Channels

Sales channels can provide timely feedback information to improve shipping, refilling, dispatching and inventory control, to provide continuity on supply and to optimize inventory level.



#### Reagent Handling Process is Traceable and Controllable

Shipping and receiving processes of reagents are automatically monitored and controlled for authorized users. Every box of reagents is traceable.

### Smart Management of Products

(It is suitable for manufacturing industry)

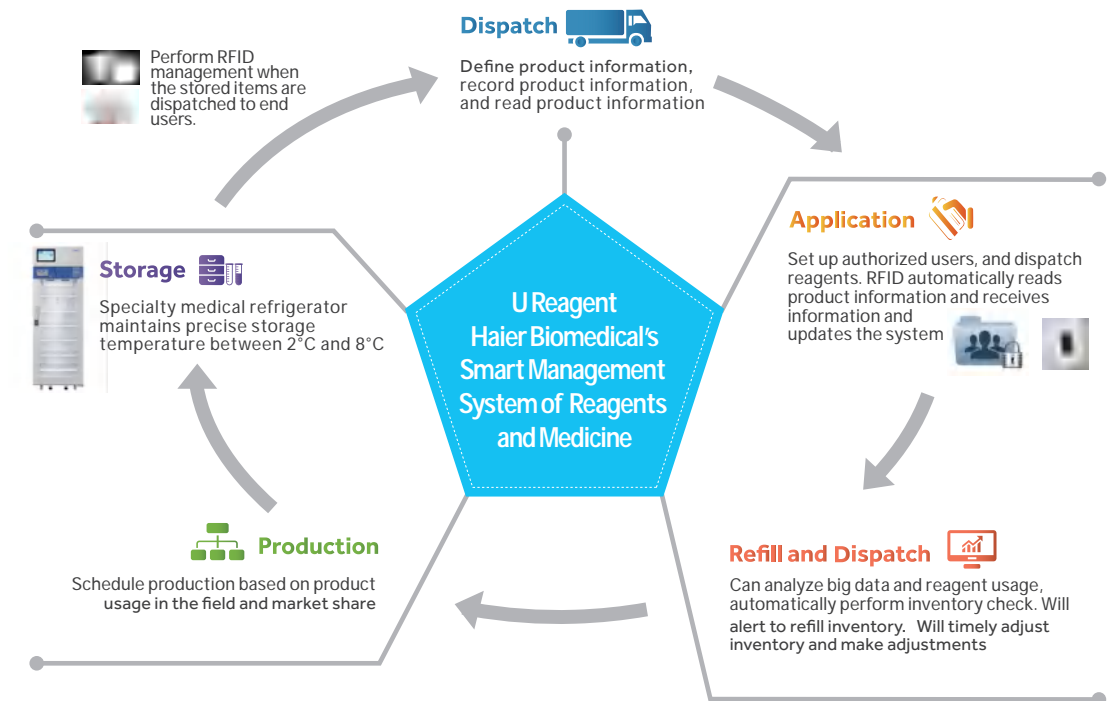

### From storage to use, the entire process is automatically and smartly controlled

(It is suitable for pharmaceutical factories, laboratories and hospitals)

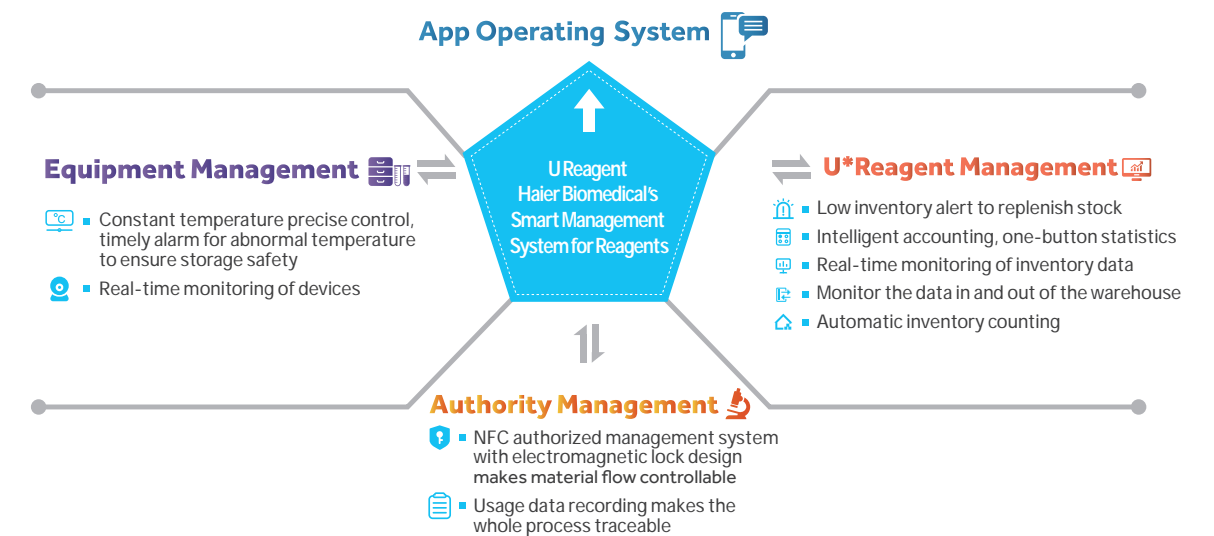

### Product Specification

Model	Voltage (V/Hz)	Power (W)	External Dimensions (W*D*H) (mm)	Internal Dimensions (W*D*H) (mm)	Effective Volume (L)	Net Weight /Gross Weight (Kg)	Shelf	Touch Screen
HYC-509R	220-240/50/60	470	693*813*1981	593*585*1500	509	180/215	6	Yes

## Advanced Pharmacy Refrigerator with Touchscreen



HYC-1099TF

HYC-509T

HYC-1099T

HYC-509TF

### Product Advantages

- Microprocessor controller, 7-inch touch screen, easy to check the cabinet temperature graph, alarm & event records and other information; authority management is standard to avoid unauthorized access or incorrect settings
- Excellent cooling performance, temperature uniformity  $\leq \pm 2^\circ\text{C}$ ; anti-freezing thermostat is equipped as standard, DIN13277 compliance
- Double-paned tempered glass door with electronic heater to reduce condensation even at  $32^\circ\text{C}$ , 80% RH ambient; self-closing door hinge with  $90^\circ$  stop; magnetic gaskets to ensure a positive seal (Solid door type is also available upon request)
- Electromagnetic lock is standard to avoid unauthorized access
- Energy efficient interior LED lighting
- Standard USB module to conveniently record and export cabinet temperature and alarm data; standard RS485 port and remote alarm contact for efficient external connection; optional printer to export cabinet temperature data
- Eco-friendly hydrocarbon refrigerant (R600a) and CFC-free polyurethane insulation for reduced global warming
- Hermetically sealed compressor, forced-air circulation with auto defrost to ensure high cooling performance
- Multiple alarm functions for safer monitoring, audible/visual alert with mute function; remote alarm contact is equipped as standard
- Adjustable plastic-coated wire shelves for improved circulation and flexible storage; fully extendable ABS drawer with divider is optional
- 25mm probe access port on side wall to accept user-provided monitoring equipment
- 4 universal casters with 2 leveling feet

## Advanced Pharmacy Refrigerator with LED Display



HYC-1099F

HYC-509

HYC-1099

HYC-509F

### Product Advantages

- Double-paned tempered glass door with electronic heater to reduce condensation even at  $32^\circ\text{C}$ , 80% RH ambient; self-closing door hinge with  $90^\circ$  stop; magnetic gaskets to ensure a positive seal
- Microprocessor controller, digital display with  $0.1^\circ\text{C}$  resolution; easy to check the min/max temperature in the past 24 hours
- Adjustable plastic-coated wire shelves for improved circulation and flexible storage; fully extendable ABS drawer with divider is optional
- Convenient security with a top-mounted unique-key lock; electromagnetic lock is optional to avoid unauthorized access
- Eco-friendly hydrocarbon refrigerant (R600a) and CFC-free polyurethane insulation for reduced global warming
- Energy efficient interior LED lighting
- Standard USB module to conveniently record and export cabinet temperature and alarm data; Standard RS485 port and remote alarm contact for efficient external connection; optional printer to export cabinet temperature data
- Multiple alarm functions for safer monitoring, audible/visual alert with mute function; remote alarm contact is equipped as standard
- Excellent cooling performance, temperature uniformity  $\leq \pm 2^\circ\text{C}$ ; anti-freezing thermostat is equipped as standard, DIN13277 compliance
- Hermetically sealed compressor, forced-air circulation with auto defrost to ensure high cooling performance
- 25mm probe access port on side wall to accept user-provided monitoring equipment
- 4 universal casters with 2 leveling feet

# Advanced Pharmacy Refrigerator with Touchscreen

# Advanced Pharmacy Refrigerator with LED Display

## Specifications



Model	HYC-509T	HYC-509TF	HYC-1099T	HYC-1099TF	HYC-509	HYC-509F	HYC-1099	HYC-1099F	
<b>Technical Data</b>									
Cabinet Type	Upright, Single Glass Door	Upright, Single Solid Door	Upright, Double Glass Door	Upright, Double Solid Door	Upright, Single Glass Door	Upright, Single Solid Door	Upright, Double Glass Door	Upright, Double Solid Door	
Climate Class	N	N	N	N	N	N	N	N	
Cooling Type	Forced Air Cooling	Forced Air Cooling	Forced Air Cooling	Forced Air Cooling	Forced Air Cooling	Forced Air Cooling	Forced Air Cooling	Forced Air Cooling	
Defrost Mode	Auto	Auto	Auto	Auto	Auto	Auto	Auto	Auto	
Refrigerant	HC	HC	HC	HC	HC	HC	HC	HC	
Sound Level (dB(A))	40	40	43	43	40	40	43	43	
<b>Performance</b>									
Temperature Range (°C)	2-8	2-8	2-8	2-8	2-8	2-8	2-8	2-8	
<b>Control</b>									
Controller	Microprocessor	Microprocessor	Microprocessor	Microprocessor	Microprocessor	Microprocessor	Microprocessor	Microprocessor	
Display	Touchscreen+LED	Touchscreen+LED	Touchscreen	Touchscreen	LED	LED	LED	LED	
<b>Electrical Data</b>									
Energy Consumption (kWh/day)	5.9	5.3	6.8	6	5.9	5.3	6.8	6	
Power Supply (V/Hz)	220-240/50/60	220-240/50/60	220-240/50/60	220-240/50/60	220-240/50/60	220-240/50/60	220-240/50/60	220-240/50/60	
Power (W)	370	315	470	440	370	315	470	440	
Electrical Current (A)	1.85	1.75	2.5	2.25	1.85	1.75	2.5	2.25	
Power Consumption (kWh/24h)	5.9	5.3	6.8	6	5.9	5.3	6.8	6	
<b>Construction</b>									
Capacity (L/Cu.Ft)	509/17.97	509/17.97	1099/38.5	1099/38.5	509/17.97	509/17.97	1099/38.5	1099/38.5	
Net/Gross Weight (approx)	kg	180/215	175/210	340/400	330/390	180/215	175/210	340/400	330/390
	lbs	396/473	385/462	748/1000	726/858	396/473	385/462	748/1000	726/858
Interior Dimensions (W*D*H)	mm	593*585*1500	593*585*1500	1295*585*1500	1295*585*1500	593*585*1500	593*585*1500	1295*585*1500	1295*585*1500
	in	23.21*22.9*58.8	23.21*22.9*58.8	50.7*22.9*58.8	50.7*22.9*58.8	23.21*22.9*58.8	23.21*22.9*58.8	50.7*22.9*58.8	50.7*22.9*58.8
Exterior Dimensions (W*D*H)	mm	693*813*1981	693*813*1981	1395*813*1981	1395*813*1981	693*813*1981	693*813*1981	1395*813*1981	1395*813*1981
	in	27.1*31.9*77.7	27.1*31.9*77.7	54.7*31.9*77.7	54.7*31.9*77.7	27.1*31.9*77.7	27.1*31.9*77.7	54.7*31.9*77.7	54.7*31.9*77.7
Packing Dimensions (W*D*H)	mm	835*915*2170	835*915*2170	1550*895*2100	1550*895*2100	835*915*2170	835*915*2170	1550*895*2100	1550*895*2100
	in	32.9*36.0*85.4	32.9*36.0*85.4	61.0*35.3*82.7	61.0*35.3*82.7	32.9*36.0*85.4	32.9*36.0*85.4	61.0*35.3*82.7	61.0*35.3*82.7
Container load (20'/40'/40'H)	14/28/28	14/28/28	7/15/15	7/15/15	14/28/28	14/28/28	7/15/15	7/15/15	
<b>Alarms</b>									
High/Low Temperature	Y	Y	Y	Y	Y	Y	Y	Y	
High Ambient Temperature	Y	Y	Y	Y	Y	Y	Y	Y	
Door Ajar	Y	Y	Y	Y	Y	Y	Y	Y	
Power Failure	Y	Y	Y	Y	Y	Y	Y	Y	
Low Battery	Y	Y	Y	Y	Y	Y	Y	Y	
Sensor Error	Y	Y	Y	Y	Y	Y	Y	Y	
Communication Failure	Y	Y	Y	Y	Y	Y	Y	Y	
Condenser Overheat	Y	Y	Y	Y	Y	Y	Y	Y	
<b>Accessories</b>									
Caster	Y	Y	Y	Y	Y	Y	Y	Y	
Foot	Y	Y	Y	Y	Y	Y	Y	Y	
Porthole	Y	Y	Y	Y	Y	Y	Y	Y	
Shelves/Drawers	Y/Optional	Y/Optional	Y/Optional	Y/Optional	Y/Optional	Y/Optional	Y/Optional	Y/Optional	
USB Interface	Y	Y	Y	Y	Y	Y	Y	Y	
Remote Alarm	Y	Y	Y	Y	Y	Y	Y	Y	
<b>Others</b>									
CE/UKCA, DIN13277 (optional)	Y	Y	Y	Y	Y	Y	Y	Y	

Product appearance and specifications are subject to change without notice



The product is used to store biological drugs and items at a temperature of 2-8°C. Typically used within pharmacy, pharma production, public health, hospitals and other life science laboratories.



HYC-309



Superior performance

- Microcomputer controller, display/control accuracy 0.1°C
- Temperature range 2-8°C, temperature uniformity  $\pm 2^{\circ}\text{C}$
- Energy-efficient conversion compressors and non-toxic, environmentally-friendly hydrocarbon refrigerant
- Self-closing door design
- Electrically heated glass door prevents condensation
- Multiple interface options - USB, RS485 and printer



Safe and reliable

- Key lock and provision for padlock to ensure safe and secure product storage
- Multiple alarms: High/Low temperature alarm, high ambient temperature alarm, door ajar alarm, power failure, low battery, sensor error, comms error and remote alarm contacts
- Alarm mode: Audible/visual and remote alarm with battery back-up which continuously alarms for up to 48 hours in the event of a power failure

Temperature Curve

HYC-309 Cooling down (ambient 32°C)

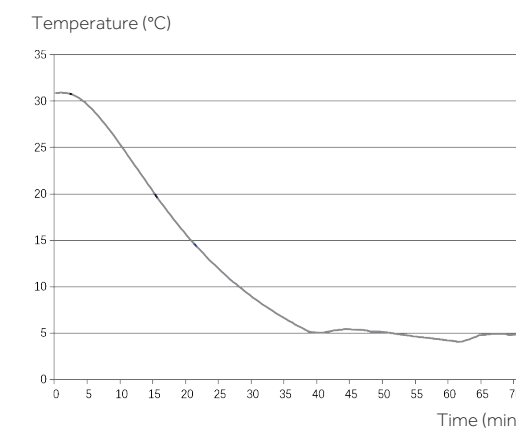

HYC-309 Stability (ambient 25°C)

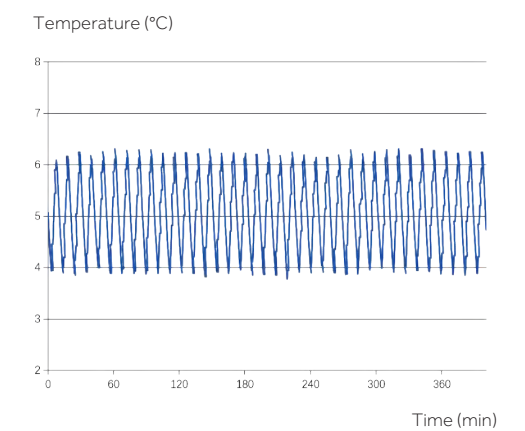

# Standard Pharmacy Refrigerator

New and improved Haier Biomedical pharmacy refrigerators now offer an improved temperature profile and more user-friendly control features.



HYC-390



## Technical Advantages

- Accurate temperature control maintains 2°C to 8°C throughout the unit with an adjustable increment at 0.1°C
- Improved user interface includes a data storage capacity of up to 10 years
- Oversized air-cooled condenser improves the robustness of the refrigeration system, reliability and refrigeration efficiency



## Ergonomic Design

- The temperature data of the newly improved storage management system is downloadable from the USB port
- Traceability of temperature data
- Heated double-pane glass door allows a clear view of stored products without condensation at 32°C and 85% relative humidity ambient conditions
- LED interior light saves energy and provides bright lighting of interior for easy product location and identification
- Shelves with label holders meet demands required for quick and effective product archiving and retrieving



## Safety

- Microprocessor control with digital display
- Temperature uniformity within 3°C
- Malfunction alarms include high/low temperature, door ajar, sensor error, power failure, low battery and remote alarm interface

## Temperature Curve

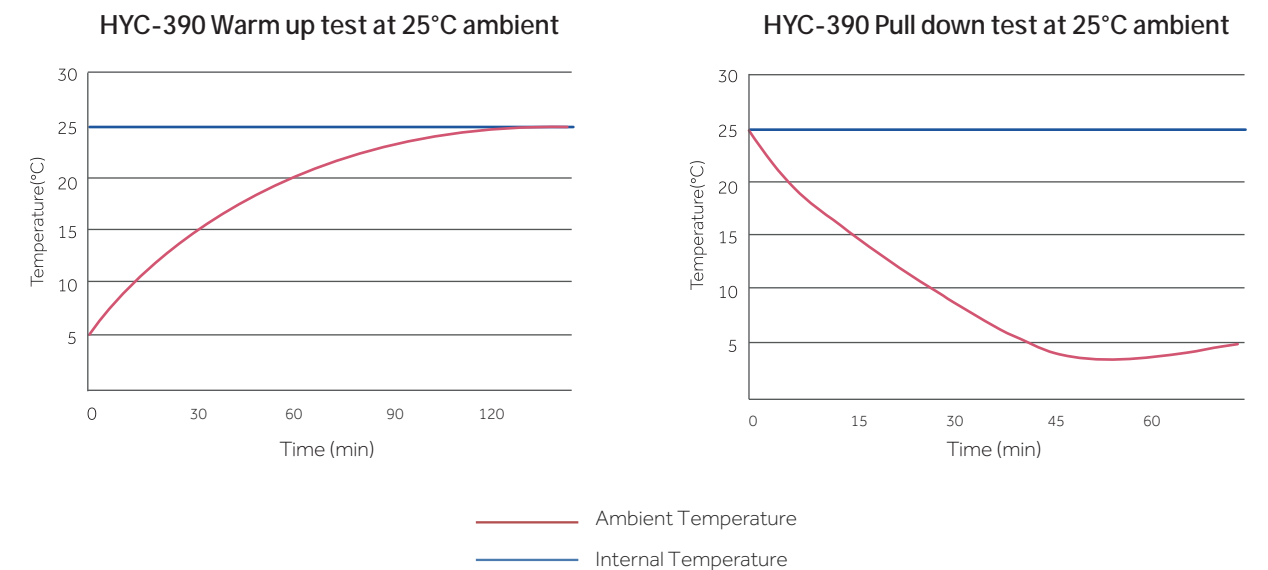

Used for storage of biological products, vaccines, drugs, reagents, etc., the unit is widely used in pharmacies, pharmaceutical factories, hospitals, CDC, laboratories as key examples.



**HYC-410**



**Superior Performance**

- Microcomputer controller, LED temperature display, accuracy 0.1°C
- Fin type evaporator and double fan system, temperature uniformity  $\pm 2^{\circ}\text{C}$
- R600a hydrocarbon refrigerant, LBA foaming agent, energy saving and environmental protection
- Optimized system and structure design, noise down to 41 dB(A)
- Panoramic glass door, LED lighting, goods are clear at a glance
- Heated door to prevent condensation
- Standard with 1 test hole, convenient for user to test interior temperature



**Safe**

- Equipped with built-in lock and security latch to accommodate a padlock, ensuring safe and reliable storage
- Multiple alarms: High and low temperature, sensor error, power failure, low battery, door ajar, high ambient temperature and communication fault alarm
- Alarm mode: audible buzzer and flashing light, remote alarm. The alarm will continue for 24 hours after power failure

**Product Details**

**Material:**

HIPS adsorption liner, sprayed steel case

**Caster and foot:**

Standard equipped with 4 universal casters and 2 adjustable feet, the refrigerator is easy to move and stabilize



**HYC-410**

\*Optional: USB, printer, RS485/232 interface

**Shelves:**

Standard with 6 shelves



**Product Performance**

**HYC-410 Cooling down (ambient 32°C)**

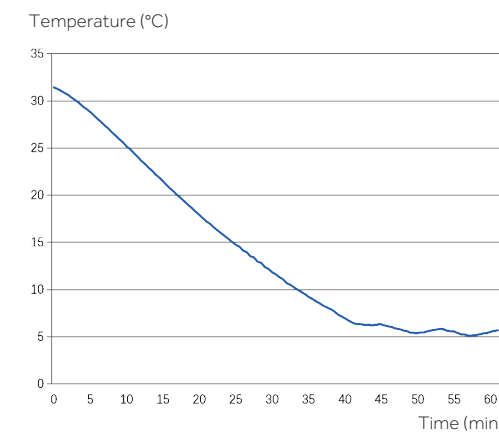

**HYC-410 Stability (ambient 25°C)**

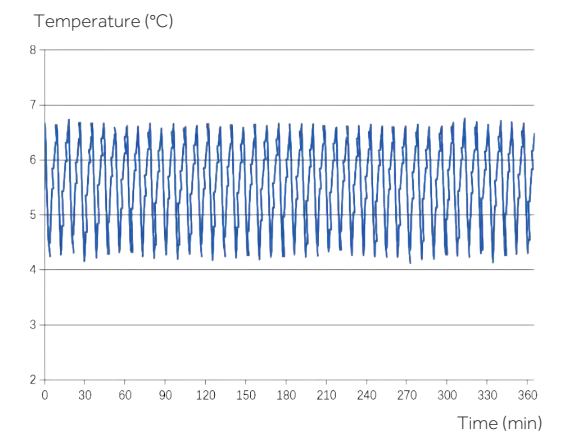



# Standard Pharmacy Refrigerator

The product is applicable to pharmacies, pharmaceutical factories, quarantine stations, health centers and hospitals, used to store biological products and those need to be stored at a temperature between 2-8°C.



220V/50HZ

115V/60HZ

HYC-639



### Energy saving

70mm thick foam layer, optimized refrigeration system, low power consumption, less than 6 kWh per day



### Environmentally-friendly

Hydrocarbon refrigerant, truly completely environmental protection refrigeration system. Polyurethane insulation layer, the whole series adopts European ROHS directive materials, for environmental protection



### Better uniformity

Finned evaporator, double fan system. The temperature is more uniform, the characteristic point temperature uniformity is  $\pm 2^{\circ}\text{C}$



### Low noise

Optimized system and structure noise reduction design



### Multi-channel sensor, reliable and safe

Equipped with upper display sensor, lower display sensor, defrosting sensor, control sensor, ambient temperature sensor, condenser dirty sensor

## Typical Performance Characteristics in 32°C Ambient Temp

HYC-639  
Cooling down (ambient 32°C)

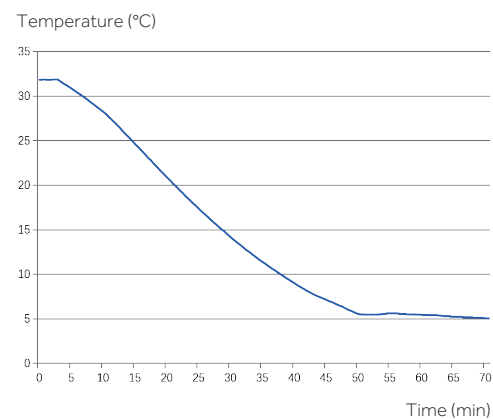

HYC-639  
Stability (ambient 25°C)

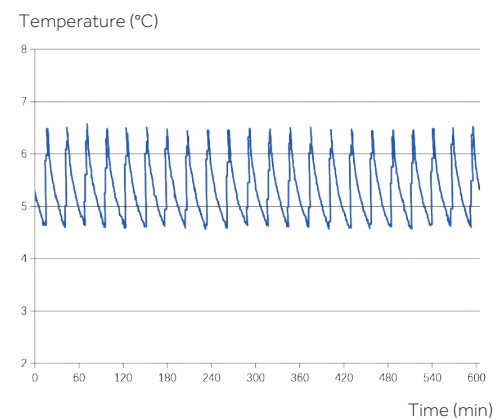

### Microprocessor control system:

Microcomputer electronic temperature controller, LED temperature display, the display accuracy is 0.1°C

Multiple alarm functions, such as high temperature alarm, low temperature alarm, sensor error alarm, power failure alarm, low battery alarm, door ajar, condenser dirty alarm, high ambient temperature alarm as key examples.

Audio and visual alarm. The equipment can be connected to the remote alarm interface



### Insulation

70mm-thick foam insulation layer to provide better insulation



### Porthole

Standard equipped with a porthole to facilitate the user to test interior temperature



### Security lock

Equipped with safety lock, safe storage of drugs



### Temperature recorder

Standard equipped with USB port, the printer and RS485 interface are optional



### Material

The inner liner is equipped with spraying steel plate for easy cleaning



### Casters and levelling leg design

Standard equipped with 4 universal casters and 2 adjustable feet to move and stabilize the equipment



### Shelves

Standard equipped with 4 shelves

The Haier Biomedical pharmacy refrigerators are suitable for pharmacies, drug stores, pharmaceutical companies, hospitals, clinics and other pharmaceutical storage areas such as storage and logistics.



HYC-1378



### Durable and Reliable - Key Features

- Energy efficient hydrocarbon (HC) refrigeration system
- Permanently lubricated cooling fan for safety and longevity
- Forced-air cooling with optimized air distribution system designed to achieve maximum temperature uniformity and stability
- Optimized refrigeration system design for more effective cooling and speedy recovery
- Temperature uniformity within  $\pm 2^{\circ}\text{C}$
- Chamber temperature range  $2\text{-}8^{\circ}\text{C}$
- Microprocessor control with large digital display. Adjustable temperature with an increment of  $0.1^{\circ}\text{C}$
- Wide voltage tolerance suitable for regions with an unstable voltage supply
- Designed for ambient temperature  $10^{\circ}\text{C}\text{-}32^{\circ}\text{C}$  with humidity below 85%



### Safety

- Equipped with a complete temperature alarm system featuring audible buzzer and visible flashing light
- Capable of alerting failures due to high or low temperature, sensor error, door ajar, remote alarm, power failure and low battery



### Ergonomic Design

- Optimized space utilization design with multi-level and adjustable shelf height to accommodate the different storage requirements of varied sized pharmaceutical products.
- Safety lock to prevent unauthorized access
- Caster design and levelling feet
- Interior light

### Product Performance

HYC-1378  
Cooling down (ambient  $32^{\circ}\text{C}$ )

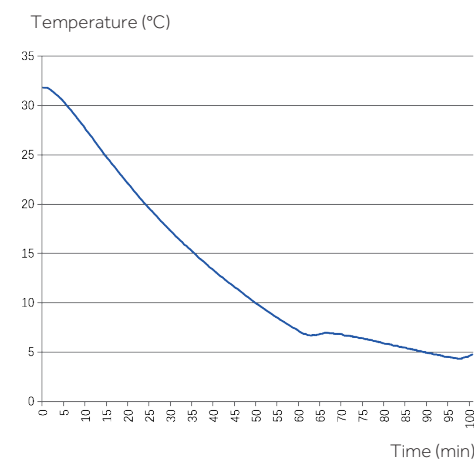

HYC-1378  
Stability (ambient  $25^{\circ}\text{C}$ )

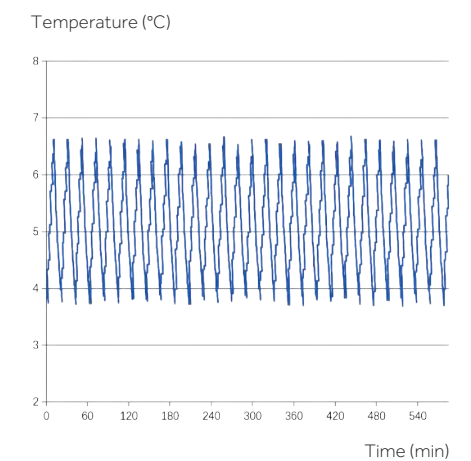

### Easy to Install, Ergonomic and Reliable

Haier Biomedical are pioneers in under-counter pharmacy refrigerator design and manufacturing, offering ultra-low noise system, safety lock, complete alarm system for sample safety and protection.



HYC-118

HYC-118A



### Reliability and Key Features

- Energy efficient hydrocarbon (HC) refrigeration system
- Permanently lubricated cooling fan for safety and longevity
- Forced-air cooling with optimized air distribution system designed to achieve maximum temperature uniformity and stability
- Optimized refrigeration system design for more effective cooling and speedy recovery
- Temperature uniformity within  $\pm 3^{\circ}\text{C}$
- Chamber temperature range  $2\text{--}8^{\circ}\text{C}$
- Microprocessor control, digital display and temperature adjustment with an increment of  $0.1^{\circ}\text{C}$
- Designed for ambient temperature  $10\text{--}32^{\circ}\text{C}$  with humidity below 70%



### Safety

- Equipped with a complete temperature alarm system featuring audible buzzer and visual flashing light
- Capable of alerting failures due to high and low temperature, sensor error, door ajar, power failure, and remote alarm interface



### Ergonomic Design

- Interior LED light
- Safety lock to prevent unauthorized access

### Product Performance

HYC-118A  
Cooling down (ambient  $32^{\circ}\text{C}$ )

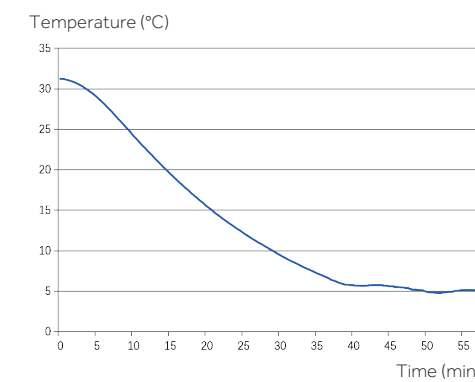

HYC-118A  
Stability (ambient  $25^{\circ}\text{C}$ )

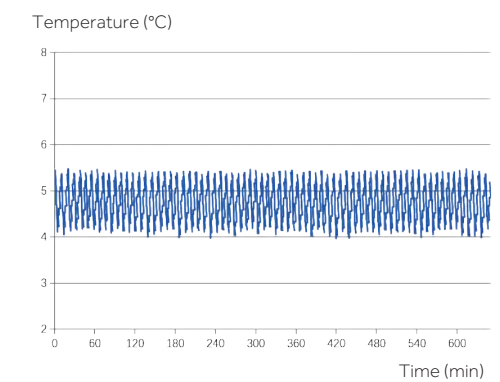



## Pharmacy Refrigerator

199/200

## Specifications

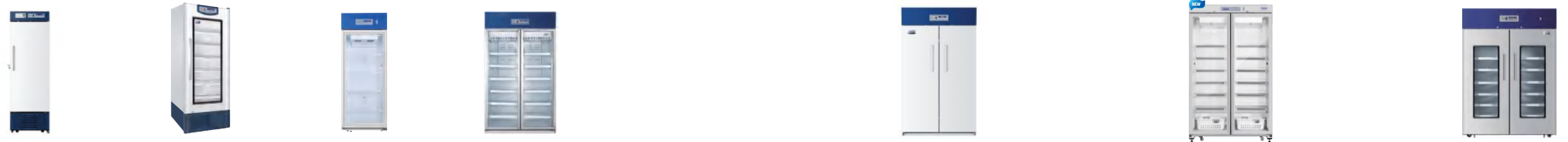

Model	HYC-390F		HYC-610		HYC-639		HYC-940		HYC-940F		HYC-1031GD		HYC-1378				
Technical Data	Cabinet Type	Upright, Single Door		Upright, Single Door		Upright, Single Door		Upright, Double Glass Door		Upright, Double Solid Door		Upright		Upright, Double Door			
	Climate Class	N		N		ST		N		N		N, 16-32°C		N			
	Cooling Type	Forced Air Cooling		Forced Air Cooling		Forced Air Cooling		Forced Air Cooling		Forced Air Cooling		Forced Air Circulation		Forced Air Cooling			
	Defrost Mode	Auto		Auto		Auto		Auto		Auto		Auto Defrost		Auto			
	Refrigerant	HC		HC		HC		HC		HC		R290, 80g		HC			
	Sound Level (dB(A))	43	43	43	45	43	46	43	45	43	43	39	43	45	45		
Performance	Temperature Range (°C)		2-8		2-8		2-8		2-8		2-8		2-8				
Control	Controller	Microprocessor		Microprocessor		Microprocessor		Microprocessor		Microprocessor		Microprocessor		Microprocessor			
	Display	LED		LED		LED		LED		LED		LED		LED			
Electrical Data	Power Supply (V/Hz)	220-240/50/60	115/60	220-240/50/60	115/60	220-240/50	115/60	220-240/50/60	115/60	220-240/50/60	220-240/50/60	220-240/50/60	115/60	115/60			
	Electrical Current (A)	1	1.5	3	6.2	2.15	2.5	3.5	7.5	2.7	2.2	3	7.5	7.5			
Dimensions	Capacity (L/Cu.Ft)	390/13.8		610/21.6		639/22.6		600/21.2		890/31.4		890/31.4		1031/36.4		1378/48.7	
	Net/Gross Weight (approx)	kg	106/129		204/227		200/240		227/279		207/259		255/265		310/360		
		lbs	233.8/284.5		449.7/500.4		551.15/639.33		500.4/615.1		456.4/571.1		562/584		683.4/793.7		
	Interior Dimensions (W*D*H)	mm	530*555*1380		680*640*1400		620*706*1520		1030*590*1425		1030*590*1425		1115*590*1670		1320*700*1500		
		in	20.9*21.9*54.3		26.8*25.2*55.1		24.4*27.8*59.8		40.6*23.2*56.1		40.6*23.2*56.1		43.9*23.2*65.7		52.0*27.6*59.1		
	Exterior Dimensions (W*D*H)	mm	665*710*1965		780*840*1945		760*897*1993		1130*755*1980		1130*755*1980		1205*800*1990		1440*950*1980		
		in	26.2*28.0*77.4		30.7*33.1*76.6		29.9*35.3*78.5		44.5*29.7*78.0		44.5*29.7*78.0		47.4*31.5*78.3		56.7*37.4*78.0		
	Packing Dimensions (W*D*H)	mm	710*810*2130		885*965*2110		910*1030*2170		1250*850*2170		1250*850*2170		1260*905*2110		1620*1040*2140		
in		27.6*31.9*83.9		34.8*38.0*83.1		35.8*40.6*85.4		49.2*33.5*85.4		49.2*33.5*85.4		49.6*35.6*83.1		63.8*41.0*84.3			
Container Load (20/40/40H)	22/44/44		12/26/26		12/24/24		10/22/22		10/22/22		10/21/21		6/14/14				
Alarms	High/Low Temperature	Y		Y		Y		Y		Y		Y		Y			
	Remote Alarm	Y		Y		Y		Y		Y		Y		Y			
	Power Failure	Y		Y		Y		Y		Y		Y		Y			
	Sensor Error	Y		Y		Y		Y		Y		Y		Y			
	Low Battery	Y		Y		Y		Y		Y		Y		Y			
	Door Ajar	Y		Y		Y		Y		Y		Y		Y			
Accessories	Caster	Y		Y		Y/4		Y		Y		4		Y			
	Foot	Y		Y		Y/2		Y		Y		2		Y			
	Porthole	Y		Y		Y		Y		Y		2		Y			
	Shelves/Drawers	7/-		6/-		4/-		12/-		12/-		12/-		12/-			
	USB Interface	Optional	Y	Optional		Y		Optional		Optional		Optional		Y			
	Printer	Optional		N/A		Optional		Optional		Optional		Optional		Optional			
	Temperature Recorder	/		Optional		/		Optional		Optional		/		Optional			
Others	Certification		CE, ENERGY STAR		CE	UL	CE	UL, ENERGY STAR, ANSI 456	CE	UL	CE	CE, DIN13277 (Optional)		CE	UL		

Product appearance and specifications are subject to change without notice

# Pharmacy Refrigerator

## Specifications



Model	HYC-68		HYC-68A		HYC-85GD	HYC-118		HYC-118A		HYC-290		HYC-309		HYC-390		HYC-410		
Cabinet Type	Upright, Solid Door		Upright, Glass Door		Table-top/Under-counter	Upright, Solid Door		Upright, Glass Door		Upright, Single Door		Upright		Upright, Single Door		Upright, Single Door		
Climate Class	N		N		N, 16-32°C	N		N		N		N		N		N		
Cooling Type	Forced Air Cooling		Forced Air Cooling		Forced Air Circulation	Forced Air Cooling		Forced Air Cooling		Forced Air Cooling		Forced Air Cooling		Forced Air Cooling		Forced Air Cooling		
Defrost Mode	Auto		Auto		Auto Defrost	Auto		Auto		Auto		Auto		Auto		Auto		
Refrigerant	HC		HC	HC	R600a	HC	HC	HC	HC	HC		HC		HC		HC		
Sound Level (dB(A))	41		41		35	41		41		43	43	41		43	43	41		
Temperature Range (°C)	2-8		2-8		2-8	2-8		2-8		2-8		2-8		2-8		2-8		
Controller	Microprocessor		Microprocessor		Microprocessor	Microprocessor		Microprocessor		Microprocessor		Microprocessor		Microprocessor		Microprocessor		
Display	LED		LED		Digital	LED		LED		LED		LED		LED		LED		
Power Supply (V/Hz)	220-240/50   115/60		220-240/50   115/60		220-240/50	220-240/50/60   115/60		220-240/50/60   115/60		115/60	220-240/50/60		220-240/50/60		115/60	220-240/50/60		
Electrical Current (A)	0.85	1.7	0.85	1.7	0.98	1.4	1.4	1.5	1.5	2.2	1.8	1.5		2.4	1.8	2.0		
Capacity (L/Cu.Ft)	68/2.4		68/2.4		85	118/4.2		118/4.2		290/10.2		309/10.91		390/13.8		410		
Net/Gross Weight (approx)	kg	38/40		38/40		36/41		41/46		46/51		105/127		77/87		116/139		
	lbs	83.8/88.2		83.8/88.2		/		90.5/101.5		101.5/112.5		231.6/280.1		169.76/191.80		255.8/306.6		
Interior Dimensions (W*D*H)	mm	415*385*505		415*385*505		405*405*555		515*415*630		530*555*1080		525*500*1290		530*555*1380		530*590*1380		
	in	16.3*15.2*19.9		16.3*15.2*19.9		/		20.3*16.3*24.8		20.9*21.9*42.5		20.67*19.69*50.79		20.9*21.9*54.3		20.9*22.8*54.3		
Exterior Dimensions (W*D*H)	mm	495*580*660		495*580*660		495*550*740		597*635*810		665*710*1665		600*630*1840		665*710*1965		665*710*1965		
	in	19.5*22.8*26.0		19.5*22.8*26.0		/		23.5*25.0*31.9		26.2*28.0*65.6		23.62*24.80*72.44		26.2*28.0*77.4		26.2*28.0*77.4		
Packing Dimensions (W*D*H)	mm	570*670*750		570*670*750		590*650*830		700*710*930		700*810*1810		680*690*1940		710*810*2130		710*810*2130		
	in	22.5*26.4*29.5		22.5*26.4*29.5		23.2*25.6*32.7		27.6*28.0*36.6		27.6*31.9*71.3		26.8*27.1*74.4		27.6*31.9*83.9		27.6*31.9*83.9		
Container load (20'/40'/40'H)	102/207/207		102/207/207		54/120/180		48/96/96		48/96/96		22/44/44		24/51/51		22/44/44		22/44/44	
High/Low Temperature	Y		Y		Y	Y		Y		Y		Y		Y		Y		
Remote Alarm	Y		Y		Y	Y		Y		Y		Y		Y		Y		
Power Failure	Y		Y		Y	Y		Y		Y		Y		Y		Y		
Sensor Error	Y		Y		Y	Y		Y		Y		Y		Y		Y		
Low Battery	Y		Y		Y	Y		Y		Y		Y		Y		Y		
Door Ajar	Y		Y		Y	Y		Y		Y		Y		Y		Y		
Caster	N		N		/	Y/2		Y/2		Y		4		Y		4		
Foot	Y/2		Y/2		2	Y/2		Y/2		Y		2		Y		2		
Porthole	Y		Y		1	Y		Y		Y		1		Y		Y		
Shelves/Drawers	2/1		2/1		2/1	3/1		3/1		5/-		5/-		7/-		6		
USB Interface	Optional		Optional		Optional	/		/		Y	Optional	Optional		Y	Optional	Optional		
Printer	N/A		N/A		N/A	N/A		N/A		Optional		Optional		Optional		Optional		
Temperature Recorder	N/A		N/A		/	N/A		N/A		/		/		/		N/A		
Certification	CE	UL	CE	UL	CE, DIN13277 (Optional)		CE	UL	CE	UL	UL	CE	CE	UL	CE	CE, ENERGY STAR		

Product appearance and specifications are subject to change without notice

# Combined Refrigerator and Freezer

## Scope of Application

This product is designed to store frozen plasma, biomaterials, vaccines, electronic devices and low temperature tests of special materials, in blood stations, hospitals, epidemic prevention stations, universities, scientific research institutes, electronic chemical industry and other enterprise laboratories.



HYCD-282

HYCD-282A



### Multipurpose and Space Efficient

- One cabinet with two independent chambers, both are self-contained and independently controlled with individual doors
- Refrigerator chamber is equipped with a double-paned glass viewing window and LED interior lighting



### Environment Friendly

Hydrocarbon refrigerant (R600a for refrigerator/R290 for freezer) and CFC-free polyurethane insulation for reduced global warming



### Stainless Steel Interior

The interior of refrigerator and freezer are both made of stainless steel, which is easy to clean and corrosion-proof



### Microprocessor Controller with Digital Display

- Refrigerator temperature 2~8°C with resolution of 0.1°C
- Freezer temperature -40~-10°C with resolution of 1°C
- Multiple alarm functions with remote alarm contact to ensure safe monitoring



### High Performance

- Refrigerator: Forced-air cooling system with cycle defrost, temperature uniformity±3°C
- Freezer: Cold wall cooling system, manual defrost, temperature uniformity±5°C
- Standard USB port & optional printer, easy to get temperature record

## Product Performance

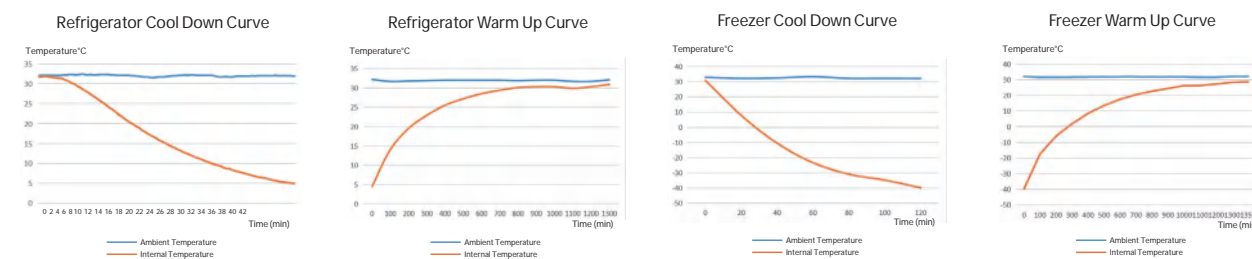

## Specifications

Model	HYCD-282		HYCD-282A	
	Refrigerator	Freezer	Refrigerator	Freezer
Technical Data	Cabinet Type		Upright	
	Climate Class		N	
	Cooling Type		Forced air cooling	Direct cooling
	Defrost Mode		Auto	Manual
	Refrigerant		R600a	R290
	Sound Level (dB(A))		43	
Performance	Temperature Range (°C)		2-8	-10--40
Control	Controller		Microprocessor	
	Display		LED	
Electrical Data	Power Supply (V/Hz)		220-240/50/60	
	Power (W)		410	
	Electrical Current (A)		2.5	
Dimensions	Capacity (L/Cu.Ft)		185/6.5	97/3.4
	Net/Gross Weight (approx) kg		145/160	
	Interior Dimensions (W*D*H) mm		605*510*720	515*465*440
	Exterior Dimensions (W*D*H) mm		735*660*1810	
	Packing Dimensions (W*D*H) mm		775*720*1930	
	Container Load (20'/40'/40'H)		21/43/43	
Alarms	High/Low Temperature		Y	Y
	Door Ajar		Y	Y
	Remote Alarm		Y	Y
	Power Failure		Y	Y
	Sensor Error		Y	Y
	Low Battery		Y	Y
	High Ambient Temp		Y	Y
	Caster		Y/4	Y/4
Accessories	Foot		Y/2	Y/2
	Porthole		Y/2	Y/2
	Shelves/Drawers		3/1	1/2 (without sliding rack)
	Stylus Printer		Optional	
	USB Interface		Y	Y
Others	Certification		CE	CE
Compressor Type		Frequency Conversion Compressor		
Compressor Quantity		2		

Product appearance and specifications are subject to change without notice



# Combined Refrigerator and Freezer

205/206

## Main Application

This product is designed to store blood plasma, biological products, vaccines, medicines and chemical reagents.



HYCD-469



Temperature Control

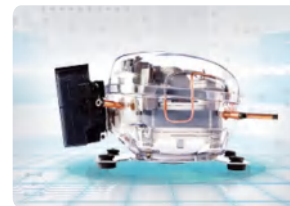

Security Guaranteed



Variable Frequency Hydrocarbon Refrigeration System



Data Storage

## Key Features



### Temperature Control

- Refrigerator temperature ranges from 2°C to 8°C
- Freezer temperature ranges adjustable from -10°C to -40°C
- Microprocessor temperature control accuracy 0.1°C (refrigerator) and 1°C (freezer)



### Safety

- Separate doors for refrigerator and freezer with independent lock catches, dual padlocks available to ensure product safety
- Multiple alarm functions including high or low temperature, sensor error, high ambient temp, power failure and remote alarm
- Two types of alarm indicators: audible buzzer and visible flashing light



### Refrigerator System

- Refrigerator and freezer have independently controlled variable frequency refrigeration systems, standalone displays as well as separate on and off controls
- Robust compressor system operating with environmentally friendly hydrocarbon refrigerant
- Refrigerator with high quality and high efficiency cooling fan provides better temperature uniformity and stability



### Ergonomic Design

- Large LED screen display for excellent user interface experience
- USB port automatically saves temperature data for up to 10 years for convenient inquiry and record keeping
- Optional printer to simultaneously print out temperatures of the refrigerator and the freezer
- Four casters and two levelling legs design for ease of maneuvering

## Specifications

Model	HYCD-319A (115V)		HYCD-469		HYCD-469A		HYCD-469A (115V)	
	Refrigerator	Freezer	Refrigerator	Freezer	Refrigerator	Freezer	Refrigerator	Freezer
Technical Data	Cabinet Type		Upright		Upright		Upright	
	Climate Class		N		N (16-32°C)		N (16-32°C)	
	Cooling Type		Forced air cooling	Direct cooling	Forced air cooling	Direct cooling	Forced air cooling	Direct cooling
	Defrost Mode		Auto	Manual	Auto	Manual	Auto	Manual
	Refrigerant		R600a 45g	R290 60g	R600a	R290	R600a	R290
	Sound Level (dB(A))		50		45		45	
Performance	Temperature Range (°C)		2-8	-15--40	2-8	-10--40	2-8	-15--40
	Control		Microprocessor		Microprocessor		Microprocessor	
Electrical Data	Display		LED		LED		LED	
	Power Supply (V/Hz)		115/60		220-240/50/60		220-240/50/60	
	Power (W)		450		640		640	
Electrical Current (A)		6		3		3		
Dimensions	Capacity (L/Cu.Ft)		200/7.06	100/3.53	269/9.5	200/7.1	269/9.5	200/7.1
	Net/Gross Weight (approx)	kg	145/160		176/207		176/207	
		lbs	319.7/352.7		388.0/456.4		388.0/456.4	
	Interior Dimensions (W*D*H)	mm	605*510*720	515*465*440	593*585*800	553*545*660	593*585*800	553*545*660
		in	23.8*20*28.3	20.2*18.3*17.3	23.3*23.0*31.5	21.8*21.5*26.0	23.3*23.0*31.5	21.8*21.5*26.0
	Exterior Dimensions (W*D*H)	mm	735*660*1810		738*834*1975		738*834*1975	
		in	28.9*26.0*71.3		29.1*32.8*77.8		29.1*32.8*77.8	
	Packing Dimensions (W*D*H)	mm	775*720*1930		800*875*2100		800*875*2100	
		in	30.5*28.3*76		31.5*34.4*82.7		31.5*34.4*82.7	
	Container Load (20'/40'/40'H)		21/43/43		14/28/28		14/28/28	
Alarms	High/Low Temperature		Y		Y		Y	
	Sensor Error		Y		Y		Y	
	Power Failure		Y		Y		Y	
	Door Ajar		Y		Y		Y	
	Remote Alarm		Y		Y		Y	
	High Ambient Temperature		Y		Y		Y	
	Low Battery		Y		Y		Y	
Accessories	Caster		Y/4		Y		Y	
	Foot		Y/2		Y		Y	
	Porthole		Y/2		Y		Y	
	Shelves/Drawers		3/1	1 (For supporting the upper drawer)/2 (without sliding rack)	3/0	3/0 (Max 3 Drawers optional, without sliding rack)	3/0	3/0 (Max 3 Drawers optional, without sliding rack)
	USB Interface		Y		Y		Y	
Others	Certification		UL, NSF/ANSI 456		CE		CE	

Product appearance and specifications are subject to change without notice



**Blood Bank  
Solutions**

# Automated Blood Management Refrigerator



## Information Flow



- Microcomputer Control**  
 The temperature inside the unit is controlled within 4±1°C with temperature control accuracy of 0.1°C and the large high-definition LCD touch screen display makes it convenient to observe.
- Inverter Compressor**  
 High efficiency and energy saving, low noise and long service life.
- Three-layer Glass Foam Door**  
 With large viewing three-layer glass foam door design, surface glass with LOW-E film to reduce heat transfer efficiency with no condensation at 25°C and 85% humidity environment.
- Standard USB Port**  
 With optional disc temperature recorder.

- Multiple Fault Alarms**  
 High/low temperature alarm, power failure alarm, door ajar, sensor error alarm, and low battery alarm. It is configured with remote alarm interface with two alarm modes (sound buzzer alarm and light flashing alarm).
- Speed Control Condenser Fan**  
 High efficiency and energy saving, low noise and long service life.
- Double Protection of Mechanical Door Lock and Electromagnetic Lock**  
 Electromagnetic lock can realize NFC card punching unlocking and fingerprint unlocking function.

## Operation Instructions

### Blood Bag Inbound:



### Blood Bag Outbound:



## Specifications

Product Model No.	Voltage (V/Hz)	Internal Temperature (°C)	External Dimension (W*D*H mm)	Internal Dimension (W*D*H mm)	Effective Volume (L)	NW / GW (Kg)	Stainless Steel Shelf (layers)	Loading Capacity (400 ml blood bag)
HXC-429TR	230V-50/60Hz	4± 1	625*940*1830	505*680*1315	429	190/230	5	120
HXC-629TR	230V-50/60Hz	4± 1	765*940*1980	645*680*1455	629	235/280	6	192
HXC-1369TR	230V-50/60Hz	4± 1	1545*940*1980	1425*680*1455	1369	430/490	12	384



# Automated Blood Management Refrigerator

## Scope of Application

Suitable for blood transfusion departments, operating rooms, and emergency rooms, etc. of the hospitals

## Product Advantages

### Drastically Improves the Speed of Delivery

Innovative blood bank system, enables the blood to be advanced to the operating room to achieve 1-minute rapid blood collection.



### Reduce Waste and Improve Efficiency

Electronic blood matching within 1 minute, reducing the cross matching time and reagent consumption. Quick and precise blood matching, combined with intelligent lighting indicators guide, guarantees the accurate identification and safe use of blood, without waste.



### Intelligent Blood Management System

Allows integration and coordination of blood recovery within hospitals and blood allocation between hospitals and even across regions through the blood network cloud platform. Enabling the rational use of blood upon demand, thus reducing resource consumption.



### Intelligent Blood Management System

Quickly and accurately identify blood bag location using onboard blood information management system.

The patient's blood matching information is shown and a blood bag automatically selected and a request for the bag is sent.

The system reads the blood information and light up indicators guide the user to the correct blood bag location.

Blood information is cross-checked and blood is issued. Inventory is automatically updated within the blood management system.

## Specifications

Model	HXC-149R	HXC-429R	HXC-629R	HXC-629RB	
Technical Data	Type	Drawer-Type	Drawer-Type	Drawer-Type	
	Climate Class	N	N	N	
	Cooling Type	Forced air cooling	Forced air cooling	Forced air cooling	
	Defrost Mode	Auto	Auto	Auto	
	Refrigerant	R600a	R600a	R600a	
Performance	Sound Level (dB(A))	40	41	41	
	Temperature Range (°C)	4±1	4±1	4±1	
Control	Ambient Temperature (°C)	16-32	16-32	16-32	
	Controller	Microprocessor	Microprocessor	Microprocessor	
Electrical Data	Display	LCD Touchscreen	LCD Touchscreen	LCD Touchscreen	
	Power Supply (V/Hz)	220-240/50/60	220-240/50/60	220-240/50/60	
	Power (W)	250	280	300	
	Electrical Current (A)	1.5	1.8	1.9	
Construction	Power Consumption (kWh/24h)	2.6	2.9	3.1	
	Capacity (L/Cu.Ft)	149/5.3	429/15.1	629/22.2	
	Blood Storage Capacity (450ml blood bags)	18	60	88	
	Net/Gross Weight (approx)	kg	129/179	245/280	295/335
		lbs	283.8/393.8	539/616	649/737
	Interior Dimensions (W*D*H)	mm	505*560*610	505*680*1315	645*680*1455
		in	19.7*32.3*23.8	19.7*26.5*51.3	25.2*26.5*56.7
	Exterior Dimensions (W*D*H)	mm	625*820*1425	925*940*1830	1065*940*1980
		in	24.4*30.2*55.6	36.1*36.7*71.4	41.5*36.7*77.2
	Packing Dimensions (W*D*H)	mm	740*945*1575	725*985*1940	875*995*2090
in		28.9*36.9*61.4	28.3*38.4*75.7	34.1*38.8*81.5	
Loading Quantities	Container load (20'/40'/40'H)	18/36/36	18/35/35	12/26/26	
	High/Low Temperature	Y	Y	Y	
Alarms	Power Failure	Y	Y	Y	
	Sensor Error	Y	Y	Y	
	Low Battery	Y	Y	Y	
	Door Ajar	Y	Y	Y	
	Caster	4	4	4	
Accessories	Foot	2	2	2	
	Porthole	Y	Y	Y	
	Drawers	9	30	44	
	USB Interface	Y	Y	Y	
	Temperature Recorder	Y	Y	Y	
	Remote Alarm	Y	Y	Y	
	RS485	Y	Y	Y	
	Certifications	CE	Y	/	Y
		UL	/	Y	/

R suffix - RFID with IoT model for blood bag management  
Product appearance and specifications are subject to change without notice

# Automated Blood Management Refrigerator

## Scope of Application

Suitable for blood transfusion departments, operating rooms, and emergency rooms

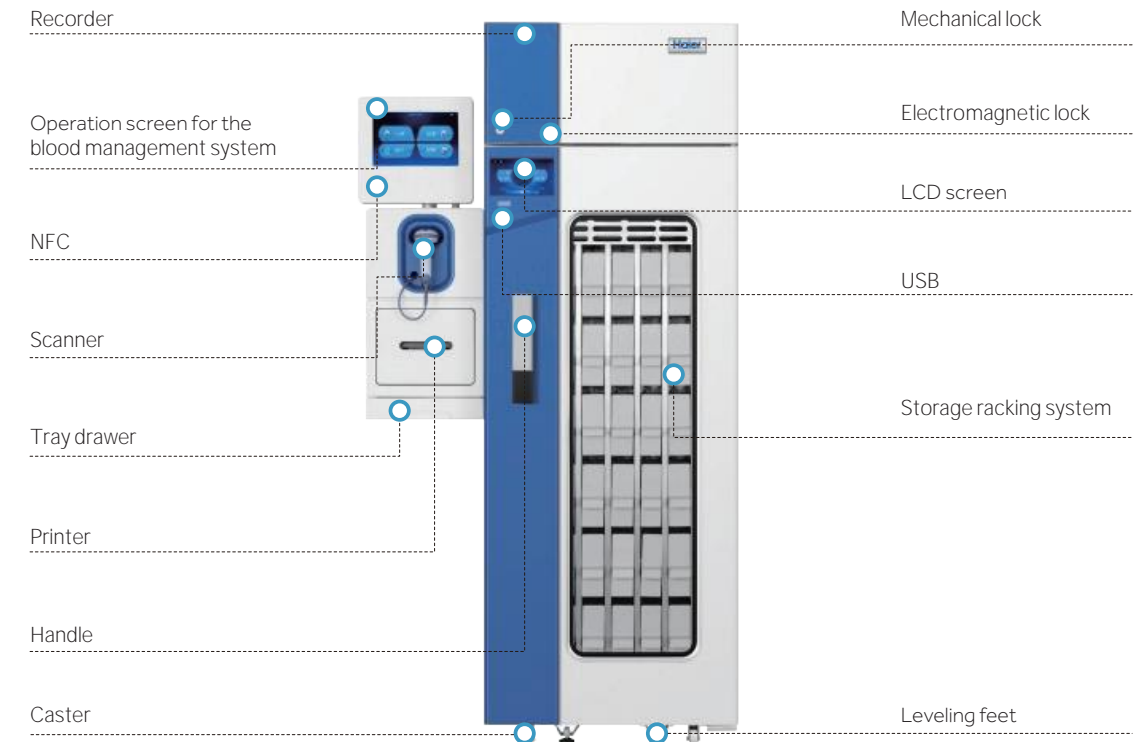

## Product Advantages

**Reduce Waste and Improve Efficiency**  
 Rapid, electronic cross matching, the RFID electronic tagged blood bag's position illuminates for quick retrieval. Request blood at bedside, allocate, collect and transfer whilst monitoring the temperature across the whole process.

**Intelligent Blood Management System**  
 Allows integration and coordination of blood recovery within hospitals and blood allocation between hospitals and even across regions through the blood network cloud platform. Enabling the rational use of blood upon demand, thus reducing resource consumption.

**Multi-mode Operation**

- Blood transfusion department mode: write the blood bag information into the RFID tag, read the tag information through the antenna board, and view the blood type, expiration date and other information
- Forward mode: operating room, emergency, ICU and other scenes
- Temporary storage mode: surgical blood preparation is temporarily stored. It can be re stored if it is not used up

**Drastically Improves the Speed of Delivery**  
 Innovative blood bank system, enables the blood to be advanced to the operating room to achieve 1-minute rapid blood collection

**Safe and Security**  
 Each drawer is equipped with an independent electronic lock to ensure that only the unique and correct blood bag can be taken out in each blood collection operation

## Ergonomic Design

**Ozone Sterilization**  
 Standard ozone module, according to the actual need to set regular disinfection time, without manual disinfection

**Automatic Inventory**  
 Automatic inventory and blood bag information at a glance



## Product Performance

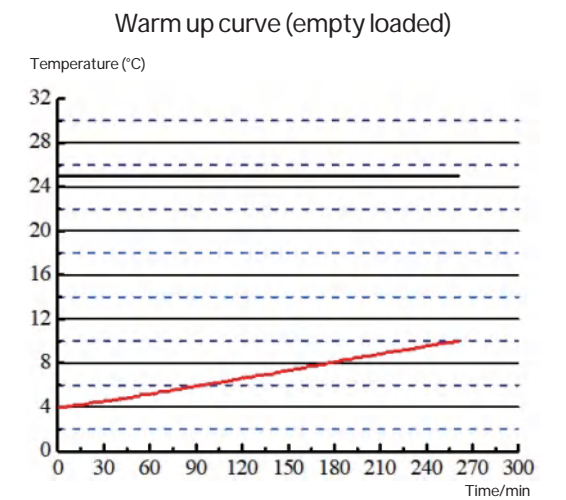
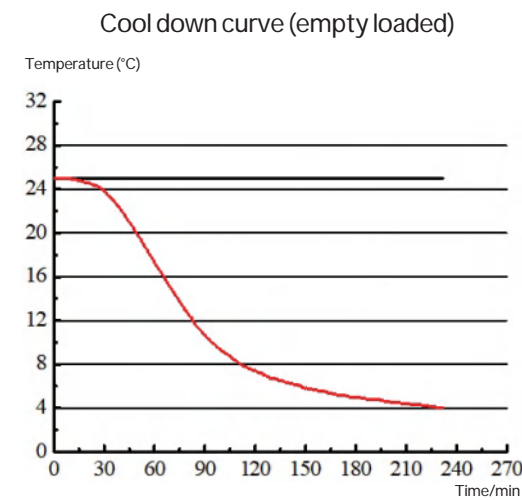

# Automated Blood Management Refrigerator

## Specifications

Model		HXC-429RV	HXC-629RV	
Technical Data	Type	Drawer-Type	Drawer-Type	
	Climate Class	N	N	
	Cooling Type	Forced air cooling	Forced air cooling	
	Defrost Mode	Auto	Auto	
	Refrigerant	R600a	R600a	
	Sound Level (dB(A))	41	41	
Performance	Temperature Range (°C)	4±1	4±1	
	Ambient Temperature (°C)	16-32	16-32	
Control	Controller	Microprocessor	Microprocessor	
	Display	LCD	LCD	
Electrical Data	Power Supply (V/Hz)	220-240V/50   230V-/50/60	220-240V/50   230V-/50/60	
	Power (W)	280	300	
	Electrical Current (A)	1.8	1.9	
	Power Consumption (kWh/24h)	2.9	/	
Dimensions	Capacity (L/Cu.Ft)	429/15.1	629/22.2	
	Blood Storage Capacity (450ml blood bags)	36	48	
	Net/Gross Weight (approx)	kg	245/280	295/335
		lbs	539/616	649/737
	Interior Dimensions (W*D*H)	mm	505*680*1315	645*680*1455
		in	19.7*26.5*51.3	25.2*26.5*56.7
	Exterior Dimensions (W*D*H)	mm	925*940*1830	1065*940*1980
		in	36.1*36.7*71.4	41.5*36.7*77.2
	Packing Dimensions (W*D*H)	mm	725*985*1940	875*995*2090
		in	28.3*38.4*75.7	34.1*38.8*81.5
Container Load (20'/40'/40'H)		18/35/35	12/26/26	
Functions	High/Low Temperature	Y	Y	
	Power Failure	Y	Y	
	Sensor Error	Y	Y	
	Low Battery	Y	Y	
	Door Ajar	Y	Y	
	Caster	4	4	
Accessories	Foot	2	2	
	Porthole	Y	Y	
	Drawers	36	48	
	USB Interface	Y	Y	
	Temperature Recorder	Y	Y	

\*Haier Biomedical reserves the right to change products and specifications without prior notice.

# Unattended Self-service Blood Distribution Refrigerator

215/216

## Self-Service Blood Distribution with Smart IoT Technology

### Self-service blood distribution for blood transfusion departments

- After blood cross matching is completed for the blood bags, specified blood collection permissions will be allocated to the different blood using departments to achieve self-help blood distribution; self-help blood collection at night can save labor cost and improve efficiency.

### Mobile blood storage points set up by blood stations

- The refrigerators may be used as mobile blood storage points in hospitals to guarantee the applications of emergency blood use, achieve zero waiting for blood use, and guarantee the timely blood use of patients.



HXC-629ZZ

## Product Advantages

### Electronic checking and bar code management

- Blood bag warehouse-in and warehouse-out management can be achieved by scanning the blood donation codes and the product codes on the bags.
- The system can take the specified blood bags for the work staff accurately after identifying the operators and checking the blood bags to be error-free.



A drawer corresponds to a lock

### Safe and reliable, making blood collection process traceable

- Equipped with fingerprint module and NFC card punching module, providing dual permission modes to open the electromagnetic lock;
- Each drawer is equipped with an independent electronic lock to ensure that only the unique and correct blood bag can be taken out in each blood collection operation;
- The camera module can take photos of the operators automatically and transmit them to the platform to achieve operation information traceability.



# Unattended Self-service Blood Distribution Refrigerator

# Unattended Self-service Blood Distribution Refrigerator

217/218



Self-service printing

## Ergonomic Design

- Smart dual screen setting realizes simple and intuitive LCD screen display and better user-machine interactions.
- Upon checking of the warehouse-out blood bag's information, self-help printing of Blood Collection Sheet for Clinical Blood Transfusion and Blood Distribution Record Sheet is available.

## User-machine interaction, making management visual

- The intelligent blood management system can display the blood donation codes, product codes, blood types, blood quantities, expiry dates and other information of the stored blood bags in real time, realizing one-key query of the stock blood information.
- It can clearly show the storage location of the blood bag with the closest expiry date and follow the first-in-first-out management practices.

## Real-time control of freezer temperature

- Double temperature control composed of 6 high precision sensors and mechanical thermostat against low temperature makes control more accurate and maintains the refrigerator temperature constant at  $4 \pm 1^\circ\text{C}$ .

## Specifications

Model	Voltage (V/Hz)	Power (W)	Temperature inside the refrigerator ( $^\circ\text{C}$ )	Uniformity ( $^\circ\text{C}$ )
HXC-629ZZ	220-240/50/60	300	2-6	4 $\pm$ 1

External dimensions (W*D*H mm)	Internal dimensions (W*D*H mm)	Effective volume (L)	Blood bag volume (400ml blood bag)	Overall construction
1290*940*1980	645*680*1455	629	72	Single door

## Scope of Application

Self-service blood bank refrigerator suitable for blood stations, haematology departments and other hospital areas to provide secure and convenient access to blood.



HXC-149ZZ

## Product Advantages



### Electronic Checking and Bar Code Management

- Blood bag inventory management (in/out) is achieved by scanning the bags' blood donation codes and product codes
- The system ensures error-free blood bag collection by accurately checking blood bag and operator information



### Real-time Control of Freezer Temperature

- Six high-precision sensors and a mechanical thermostat accurately control the temperature in real-time to maintain the refrigerator temperature at  $4 \pm 1^\circ\text{C}$



### Ergonomic Design

- The intelligent, dual-screen LCDs have been designed for better user-machine interactions
- Users can print Blood Collection Sheets for Blood Transfusion and Blood Distribution Records after blood check-out



### Safe, Reliable and Traceable

- Equipped with fingerprint and NFC access modules providing dual permission modes to open the electromagnetic lock
- Each drawer is equipped with an independent electronic lock to ensure that only the unique and correct blood bag can be taken out in each blood collection operation
- The camera module can take photos of the operators automatically and transmit them to the platform to achieve operation information trace-ability



### Visual and Clear Management via User Interface

- The intelligent blood management system can display the blood donation codes, product codes, blood types, blood quantities, expiry dates and other information of the stored blood bags in real time, realizing one-key query of the stock blood information
- It can clearly show the storage location of the blood bag with the closest expiry date and follow the first-in-first-out management practices



A drawer corresponds to a lock

# Unattended Self-service Blood Distribution Refrigerator

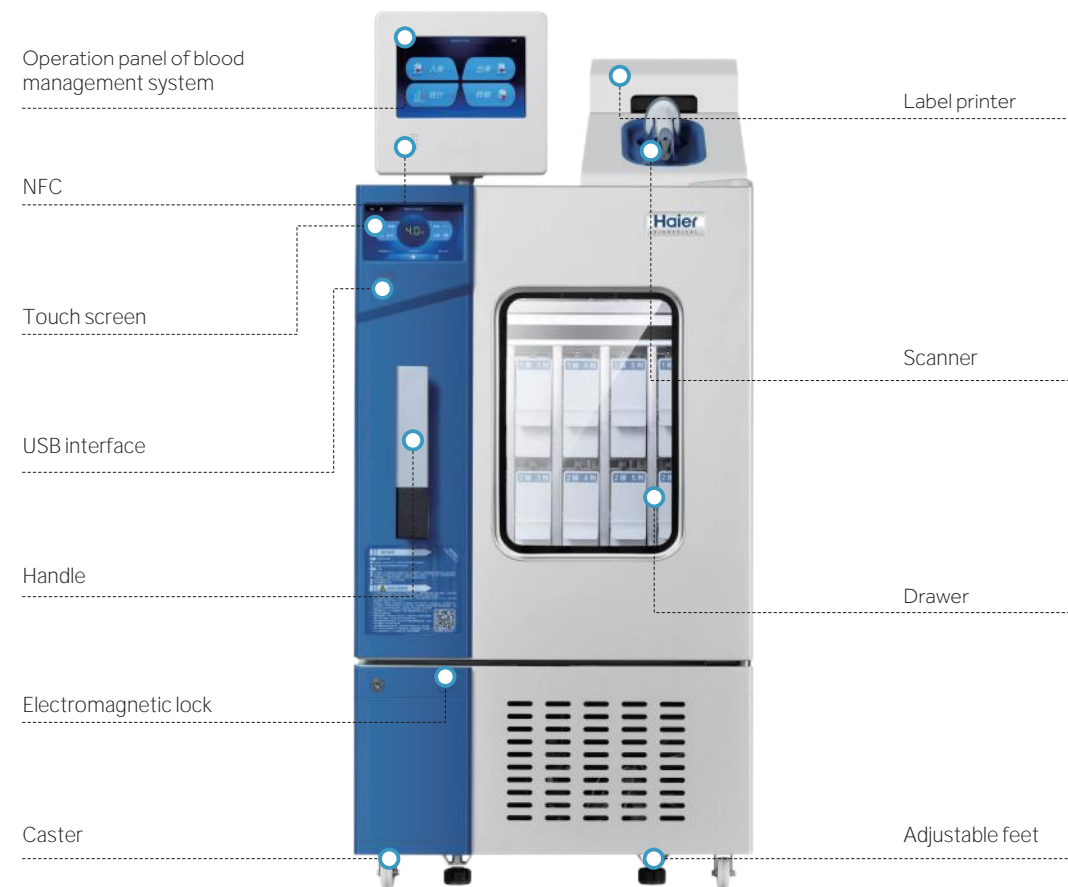

## Product Performance

Cool down curve (empty loaded)

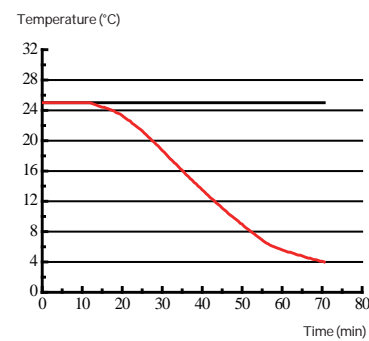

Warm up curve (empty loaded)

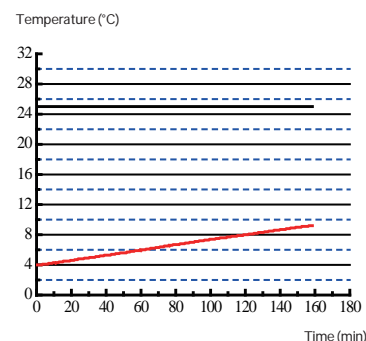

Stable operating curve (empty loaded)

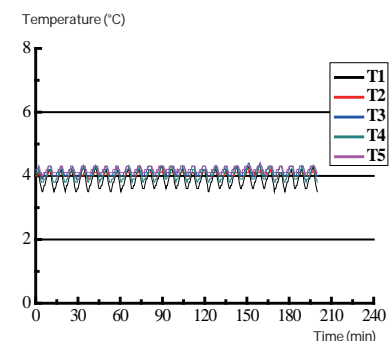

## Specifications

Model		HXC-149ZZ	
Technical Data	Type	Drawer-Type	
	Climate Class	N	
	Cooling Type	Forced air cooling	
	Defrost Mode	Auto	
	Refrigerant	R600a	
Performance	Sound Level (dB(A))	40	
	Temperature Range (°C)	4±1	
Performance	Ambient Temperature (°C)	16-32	
	Controller	Microprocessor	
Control	Display	LCD	
	Power Supply (V/Hz)	220-240V-50Hz	
Electrical Data	Power (W)	240	
	Electrical Current (A)	1.4	
	Capacity (L/Cu.Ft)	149/5.26	
Dimensions	Blood Storage Capacity (450ml blood bags)	12	
	Net/Gross Weight (approx)	kg	129/179
		lbs	283.8/393.8
	Interior Dimensions (W*D*H)	mm	505*560*610
		in	19.7*32.3*23.8
	Exterior Dimensions (W*D*H)	mm	625*820*1425
		in	24.4*30.2*55.6
	Packing Dimensions (W*D*H)	mm	740*945*1575
		in	28.9*36.9*61.4
	Container Load (20'/40'/40'H)		18/36/36
Functions	High/Low Temperature	Y	
	Power Failure	Y	
	Sensor Error	Y	
	Low Battery	Y	
	Door Ajar	Y	
	Remote Alarm	Y	
Accessories	Caster	4	
	Foot	2	
	Porthole	Y	
	Baskets	/	
	Shelves/Drawers	0/12	
	Inner doors	/	
	USB Interface	Y	
Others	Temperature Recorder	optional	
	Certification	CE (coming soon)	

\*Haier Biomedical reserves the right to change products and specifications without prior notice.

## Advanced Blood Bank Refrigerator with LCD Touchscreen

## Advanced Blood Bank refrigerator with LED Display

221/222



HXC-1369T

HXC-629T

HXC-429T

HXC-149T



HXC-1369

HXC-629

HXC-429

HXC-149

## Product Advantages



## Control Interface

- The simple and intuitive high-definition LCD touch screen can display temperature graph, working status, events and alarm record.

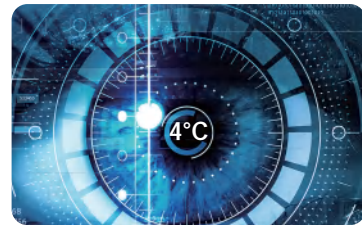

## Microprocessor Control

- A dual control system of six high-precision sensors and mechanical thermostat ensures that the temperature inside the cabinet is maintained at  $4 \pm 1^\circ\text{C}$ .



## Stable and Reliable Operation

- The refrigeration system is powered with a high-quality, energy-efficient inverter compressor and variable speed fan motors. Temperature control responds quickly and reliably for a more uniform temperature using less power and lower noise.

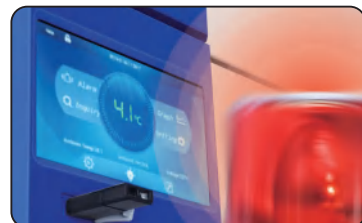

## Multiple Safety Protection

- Multiple alarms include high and low temperature, power failure, door ajar, sensor error, and low battery. Sound buzzer, visual flashing light and remote contacts are standard alarm features. Built-in battery provides power to the alarm system in the event of a main power failure. Fingerprint and standard NFC swipe card module are optional.
- Optional fingerprint and standard NFC swipe card module.

## Product Advantages



## With Multiple Temperature Control to Guarantee Constant and Precise Temperature

- The inside temperature is constant within  $4 \pm 1^\circ\text{C}$ , the digital temperature display resolution at  $0.1^\circ\text{C}$ .
- Equipped with 6 high-precision sensors and a mechanical thermostat which enables more accurate air cooling and temperature control to ensure uniform temperature inside the unit, maintained within the specified temperature range. The multi-layer inner door design reduces thermal loss after door openings and further ensures the temperature stability inside the cabinet.



## With Multiple Safety Guarantees to Provide Worry-Free Service

- Equipped with complete alarm function, including alarm on high and low temperature, power failure, door ajar, sensor error, and low battery. Two alarm modes including audible buzzer and visual lights with remote alarm interface.
- Back-up battery design ensures alarm and temperature readings continue to operate in the event of a main power failure.
- NFC swipe card module, with safer storage management.



## Standard USB Interface

- Ability to record temperature data for ten years by using the USB interface, an optional disc temperature recorder is also available



## Blood Bank Refrigerator

223/224

## Specifications

Model	HXC-149		HXC-429		HXC-629		HXC-629B		HXC-1369		HXC-149T		HXC-279T		HXC-429T		HXC-629T		HXC-629TB		HXC-1369T			
Technical Data	Type	Basket-Type		Basket-Type		Basket-Type		Basket-Type		Basket-Type		Drawer-Type		Basket-Type		Drawer-Type		Drawer-Type		Drawer-Type		Drawer-Type		
	Climate Class	N		N		N		N		N		N		N		N		N		N		N		
	Cooling Type	Forced Air Cooling		Forced Air Cooling		Forced Air Cooling		Forced Air Cooling		Forced Air Cooling		Forced Air Cooling		Forced Air Cooling		Forced Air Cooling		Forced Air Cooling		Forced Air Cooling		Forced Air Cooling		
	Defrost Mode	Auto		Auto		Auto		Auto		Auto		Auto		Auto		Auto		Auto		Auto		Auto		
	Refrigerant	R600a		R600a		R600a		R600a		R600a		R600a		R600a		R600a		R600a		R600a		R600a		
	Sound Level (dB(A))	39		40		40		41		41		39		41		40		40		41		41		
Performance	Temperature Range (°C)	4±1		4±1		4±1		4±1		4±1		4±1		4±1		4±1		4±1		4±1		4±1		
	Ambient Temperature (°C)	16-32		16-32		16-32		16-32		16-32		16-32		16-32		16-32		16-32		16-32		16-32		
Control	Controller	Microprocessor		Microprocessor		Microprocessor		Microprocessor		Microprocessor		Microprocessor		Microprocessor		Microprocessor		Microprocessor		Microprocessor		Microprocessor		
	Display	LED		LED		LED		LED		LED		LCD		LCD Touchscreen		LCD		LCD		LCD		LCD		
Electrical Data	Power Supply (V/Hz)	220-240/50/60		220-240/50/60		220-240/50/60		115/60		220-240/50/60		220-240/50/60		220/50		220-240/50/60		220-240/50/60		115/60		220-240/50/60		
	Power (W)	240		245		255		255		400		240		400		245		255		255		400		
	Electrical Current (A)	1.4		1.5		1.5		3		2		1.4		2.6		1.5		1.5		3		2		
	Power Consumption (kWh/24h)	2.5		2.8		2.9		3.6		3.5		2.5		5.1		2.8		2.9		3.6		3.5		
Construction	Capacity (L/Cu.Ft)	149/5.3		429/15.1		629/22.2		629/22.2		1369/48.3		149/5.3		279/9.85		429/15.1		629/22.2		629/22.2		1369/48.3		
	Blood Storage Capacity (450ml blood bags)	60		195		312		312		624		60		135		195		312		312		624		
	Net/Gross Weight (approx)	kg	97/125		169/204		187/217		187/217		345/410		108/136		113/136		182/217		212/252		212/252		380/445	
		lbs	213.4/275		371.8/448.8		411.4/477.4		411.4/477.4		759/902		237.6/299.2		249/299.2		400.4/477.4		466.4/554.4		466.4/554.4		836/979	
	Interior Dimensions (W*D*H)	mm	505*560*610		505*680*1315		645*680*1455		645*680*1455		1425*680*1455		505*560*610		505*410*1365		505*680*1315		645*680*1455		645*680*1455		1425*680*1455	
		in	19.7*32.3*23.8		19.7*26.5*51.3		25.2*26.5*56.7		25.2*26.5*56.7		55.6*26.5*56.7		19.7*32.3*23.8		19.8*16.1*53.7		19.7*26.5*51.3		25.2*26.5*56.7		25.2*26.5*56.7		55.6*26.5*56.7	
	Exterior Dimensions (W*D*H)	mm	625*820*1150		625*940*1830		765*940*1980		765*940*1980		1545*940*1980		625*820*1150		660*705*1750		625*940*1830		765*940*1980		765*940*1980		1545*940*1980	
		in	24.4*30.2*44.9		24.4*36.7*71.4		29.8*36.7*77.2		29.8*36.7*77.2		60.3*36.7*77.2		24.4*30.2*44.9		26.0*27.8*68.9		24.4*36.7*71.4		29.8*36.7*77.2		29.8*36.7*77.2		60.3*36.7*77.2	
Packing Dimensions (W*D*H)	mm	720*920*1220		725*985*1940		875*995*2090		875*995*2090		1610*995*2090		720*920*1220		730*760*1940		725*985*1940		875*995*2090		875*995*2090		1610*995*2090		
	in	28.1*35.9*47.6		28.3*38.4*75.7		34.1*38.8*81.5		34.1*38.8*81.5		62.8*38.8*81.5		28.1*35.9*47.6		28.7*30.0*76.4		28.3*38.4*75.7		34.1*38.8*81.5		34.1*38.8*81.5		62.8*38.8*81.5		
Loading Quantities	Container load (20'/40'/40'H)	18/38/76		18/35/35		12/26/26		12/26/26		7/14/14		18/38/76		24/48/48		18/35/35		12/26/26		12/26/26		7/14/14		
Alarms	High/Low Temperature	Y		Y		Y		Y		Y		Y		Y		Y		Y		Y		Y		
	Power Failure	Y		Y		Y		Y		Y		Y		Y		Y		Y		Y		Y		
	Sensor Error	Y		Y		Y		Y		Y		Y		Y		Y		Y		Y		Y		
	Low Battery	Y		Y		Y		Y		Y		Y		Y		Y		Y		Y		Y		
	Door Ajar	Y		Y		Y		Y		Y		Y		Y		Y		Y		Y		Y		
	Dirty condenser	Y		Y		Y		Y		Y		Y		Y		Y		Y		Y		Y		
Accessories	Caster	4		4		4		4		4		4		Y		4		4		4		4		
	Foot	2		2		2		2		2		2		Y		2		2		2		2		
	Porthole	Y		Y		Y		Y		Y		Y		Y		Y		Y		Y		Y		
	Baskets	6		15		24		24		48		6		15		15		24		24		48		
	Shelves/Drawers	2/0		5/0		6/0		6/0		12/0		0/2		5/0		0/5		0/6		0/6		0/12		
	Inner doors	2		5		6		6		12		0		5		0		0		0		0		
	USB Interface	Y		Y		Y		Y		Y		Y		Y		Y		Y		Y		Y		
	Remote Alarm	Y		Y		Y		Y		Y		Y		Y		Y		Y		Y		Y		
Temperature Recorder	Optional		Y		Y		Y		Y		Y		Y		Y		Y		Y		Y			
Certifications	CE	Y	/	Y	/	Y	/	/	Y	/	Y	/	/	Y	/	Y	/	/	Y	/	Y	/		
	UL	/	Y	/	Y	/	Y	Y	/	Y	/	Y	/	/	Y	/	Y	Y	Y	/	Y	Y		

T suffix - Advanced with touchscreen

Product appearance and specifications are subject to change without notice

# 4°C Blood Bank Refrigerator

Haier Biomedical's 4 °C Medical Blood Bank Refrigerator  
High efficiency, energy-saving, safe and reliable, smart control.



HXC-106



### Microprocessor Control System

The temperature range is 4±1°C, with temperature accuracy of 0.1°C.



### Air Cooling Design

The temperature in all corners of the cabinet is maintained within the calibrated temperature range, and the test hole design is added to meet the actual needs of the user.



### Multiple Fault Alarms

High and low temperature alarm, power failure alarm, door ajar alarm, sensor error alarm, low battery with a remote alarm interface, two alarm modes (sound beeping alarm and light flashing alarm).



### Multiple Protection

Startup delay protection, stop interval protection, display panel password protection, power failure memory data protection, sensor error protection.



### Remote Alarm Function

Can connect alarm to other rooms to achieve alarm function.



### Automatic Evaporation of Condensed Water after Collection

Avoid the trouble of manual treatment of condensed water.

## Product Features

### Door design

Vertical single door design, double layer electric heated glass door and self - closing function.

### Materials

The shell and inner liner are sprayed with steel plate, which is anticorrosive and bacteriostatic.

### Compressor

Deeply optimized refrigeration system, international brand compressor, energy saving, low noise, long service life.

### Interior lighting:

The cabinet is equipped with LED lights and external independent light switches.

### Door lock and door lock alarm:

Prevent random door opening.

### Door handle:

Easy to open

### Foot:

Stable and adjustable

### LED digital display:

The internal temperature 2-6°C, digital display of upper and lower temperature, the average temperature display and the resolution of 0.1°C.

### Air cooling design:

Ensure that the temperature in any corner of the box is maintained within the calibration temperature range.

The temperature measuring box is used to monitor the temperature in the cabinet in real time.

3 shelves, 4 blood baskets, blood basket with a label slot, easy to label. Capable of storing 54 bags of 400ml blood totally .

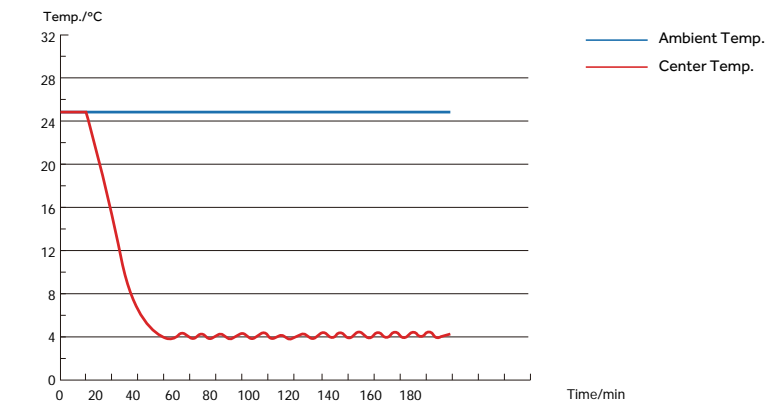

Temperature drop and insulation curve

# 4°C Blood Bank Refrigerator

227/228

The blood bank refrigerator is designed for blood collection housing, providing a safe and secure 2-6°C storage environment after the blood has been collected.



HXC-279

### Safe storage and optimum operation experience

- 60mm thick foam layer, superior insulation, ensuring the temperature is stable in the refrigerator;
- Five shelves and five inner doors design minimizes the cold loss;
- 15 blood baskets with labels. The maximum blood storage capacity is 135 bags (400/450ml);

### Long insulation time

Under full load and power off conditions, holdover time for 4°C to 6°C is more than 150 minutes, more secure.

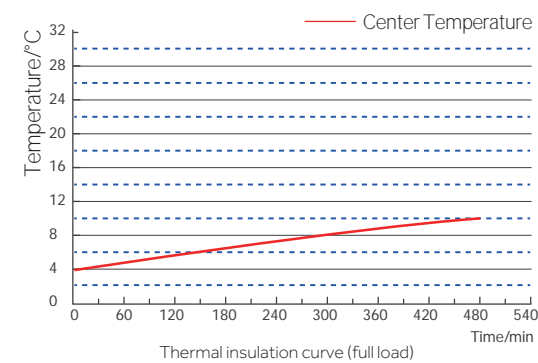

### Rapid refrigeration, high efficiency

It can reach set temperature within 35 mins under no load condition at room temperature.

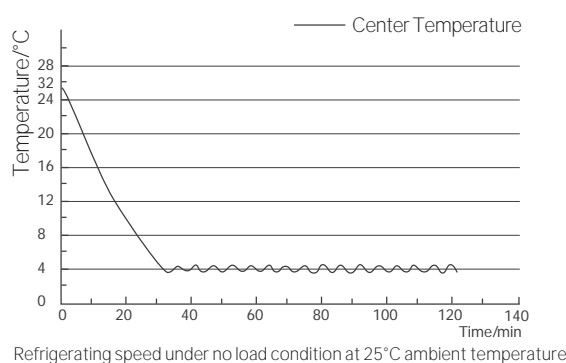

## Specifications

Model	HXC-106	HXC-279		
Technical Data	Type	Basket-Type	Basket-Type	
	Climate Class	N	N	
	Cooling Type	Forced air cooling	Forced air cooling	
	Defrost Mode	Auto	Auto	
	Refrigerant	HC	R134A	
Performance	Sound level (dB(A))	42	41	
	Temperature Range (°C)	4±1	4±1	
Control	Ambient Temperature (°C)	10-38	16-32	
	Controller	Microprocessor	Microprocessor	
Electrical Data	Display	LED	LED	
	Power Supply (V/Hz)	220-240/50/60	220/50	
	Power (W)	253	400	
	Electrical Current (A)	1.6	2.6	
Construction	Power Consumption (kWh/24h)	3.8	5.1	
	Capacity (L/Cu.Ft)	106/3.75	279/9.85	
	Blood Storage Capacity	54 (400ml blood bags)	135	
	Net/Gross Weight (approx)	(kg)	49/52	113/136
		(lbs)	108.03/114.64	249/299.2
	Interior Dimensions (W*D*H)	(mm)	430*350*830	505*410*1315
		(in)	16.93*13.78*32.68	19.8*16.1*51.8
Exterior Dimensions (W*D*H)	(mm)	500*514*1055	660*705*1700	
	(in)	19.69*20.24*41.54	26.0*27.8*67.0	
Packing Dimensions (W*D*H)	(mm)	565*615*1145	730*760*1890	
	(in)	22.24*24.21*45.08	28.7*30.0*74.4	
Loading Quantities	Container load (20'/40'/40'H)	36/72/72	24/48/48	
Alarms	High/Low Temperature	Y	Y	
	Power Failure	Y	Y	
	Sensor Error	Y	Y	
	Low Battery	Y	Y	
	Door Ajar	Y	Y	
Accessories	Caster	Y	Y	
	Foot	Y	Y	
	Porthole	Y	Y	
	Shelves/Baskets	3/4	5/0	
	Inner doors	/	5	
	Remote Alarm	Y	Y	
Certification	USB Interface	/	N	
	CE	Y	/	

Product appearance and specifications are subject to change without notice



Applicable for the storage of blood and blood related products and other items that need to be stored at 2-6°C in hospitals and blood stations.



HXC-158

### Innovative Design

- Frequency Conversion Compressor
- Adjustable Shelf And Basket
- Condensation Free Design
- Intelligent Alarm

### Product Advantages



#### Adjustable Shelves

The shelves are adjustable to any height to fulfill different requirements



#### Three Types of Alarm

Audible buzzer, visible flashing light, remote alarm



#### Five Alarm Functions

High/low temperature, power failure, sensor error, low battery, door ajar



#### Superior Performance

Adopting air cooling technology for the inside temperature uniformity and stability

### Specifications

Model		HXC-158	HXC-158B	HXC-358	
Technical Data	Type	Basket-Type	Drawer-Type	Basket-Type	
	Climate class	ST	ST	ST	
	Cooling type	Forced air cooling	Forced air cooling	Forced air cooling	
	Defrost mode	Auto	Auto	Auto	
	Refrigerant	HC	HC	CFC-Free	
	Noise (dB(A))	42	42	43	
Performance	Temperature range (°C)	4±1	4±1	2-6	
	Ambient temperature (°C)	10-38	10-38	10-38	
Control	Controller	Microprocessor	Microprocessor	Microprocessor	
	Display	LED	LED	LED	
Electrical Data	Power supply (V/Hz)	220-240/50/60	220-240/50/60	220-240/50/60	
	Power (W)	320	320	460W	
	Electrical current (A)	2.6	2.6	3	
Dimensions	Capacity (L/Cu.Ft)	158/5.6	158/5.6	358/12.7	
	Blood storage capacity (450ml blood bags)	84	84	200	
	Net/Gross weight (approx)	kg	107/120	113/126	158/174
		lbs	235.9/264.6	249.1/277.8	348.3/383.6
	Interior dimensions (W*D*H)	mm	460*370*950	460*370*950	620*490*1160
		in	18.1*14.6*37.4	18.1*14.6*37.4	24.4*19.3*45.7
	Exterior dimensions (W*D*H)	mm	560*570*1530	560*570*1530	720*690*1730
		in	22.0*22.4*60.2	22.0*22.4*60.2	28.3*27.2*68.1
	Packing dimensions (W*D*H)	mm	645*675*1680	645*675*1680	795*805*1870
		in	25.4*26.6*66.1	25.4*26.6*66.1	31.3*31.7*73.6
Alarms	Container load (20'/40'/40'H)	27/54/54	27/54/54	14/30/30	
	High/Low temperature	Y	Y	Y	
	Power failure	Y	Y	Y	
	Sensor error	Y	Y	Y	
	Low battery	Y	Y	Y	
	Door ajar	Y	Y	Y	
	Remote alarm	Y	Y	Y	
Accessories	Caster	Y	Y	Y	
	Foot	Y	Y	Y	
	Test hole	Y	Y	Y	
	Shelves/Basket	4/4	-	5/20	
	Drawers/Inner doors	-/2	4/-	-/3	
	USB interface	Optional	Optional	Optional	
	Temp recorder	Optional	Y	Y	
Others	Certification	CE	CE	CE	

## RFID Solution with Real-Time IoT Technology



DW-30L1280FT

- RFID radio frequency, accurate management of plasma information, with automatic inventory and quick inquiry function.
- Hydrocarbon refrigeration, efficient and quick.
- Mobile terminal bio-link APP ensures real-time monitoring.
- Multiple alarms, safe and reliable.
- 10-inch large screen, easy to operate and more intuitive display.
- NFC permission management system combined with an electromagnetic lock, controllable flow direction and traceable information.

### 10-inch large touch screen, easy to operate, intuitive display.



- The 10-inch large touch screen ensures an easier operating experience. Capable of displaying interior real-time temperature, ambient temperature, temperature set point, input voltage, network status, user login status, temperature curve and new message/notebook, etc. Query interface can display plasma donation code, product code, blood type, blood volume, period of validity, etc.

### Equipped with IoT function, ensuring real-time temperature monitoring.



- Equipped with IoT function, capable of sending users the equipment alarm information in the form of text messages. Download bio-link APP to monitor and check cabinet temperature, alarms and event logs from anywhere at anytime.

### Bottom air inlet system, low noise



- Equipped with a special filter, ensuring the cleanness and safety of interior air.



### Multi-compartment Storage Basket

- Multi-compartment storage basket design, streamlines plasma storage and placement, easy to access.



### Dual Cooling System, Frost Free

- Equipped with dual cooling system, if one system fails, the other system can maintain the interior temperature at -25°C for an extended period, safe and reliable.
- RFID read-write board can read plasma label information, providing inventory plasma information statistics. Supports automatic inventory, one-key inventory and plasma in-out stock storage information.

## Specifications

Model	Voltage (V/Hz)	Interior Temperature (°C)	Exterior Dimension (W*D*H mm)	Interior Dimension (W*D*H mm)	Effective Volume (L)	N.W./G.W. (kg)	loading Qty (bag)
DW-30L1280FT	220/50	-10--35	1520*1065*1980	1320*752*1260	1280	440/505	576

Process is completely traceable with intelligent interconnection methods, this design improves the safety and security for the donor.



### Identity Recognition

Built-in intelligent identity recognition system can identify a person immediately and accurately through multiple sources, such as face, ID card and fingerprint as key examples.

### Intelligent identification, safe and effective error prevention system

Precise control and accurate identification of the anticoagulant bags, improved safety, reliability and security.

### Smart IoT

Intelligent interconnection with the management system, data at a glance, clear and convenient.

### Ergonomic

Suitable for plasma stations and mobile collections with limited space.

## Ergonomic Design



Intelligent connectivity which ensures automatic data collection and processing.



Large color touch screen, easy to operate.



The unit is small in size, movable and easy to use, which reduces the burden of users.



Optimized system and structural noise reduction design, low operating noise.



## The whole process of blood component (plasma) separation is traceable

- The whole process can be automatically monitored and managed.
- Automatic recording and uploading data.
- Precise control of data is immediate.



### Data and identity protection system

The separator can collect information in multiple dimensions including ID card, face, fingerprint and bar code. Then the system will recognize the accurate information from the database, ensuring no inaccuracy of donor or recipient information is contaminated.



### Automatic data processing

The separator can record and upload consumables and collect data automatically and intelligently without manpower, this improves efficiency and prevents errors, which saves medical staff precious time and reduces stress.



### The monitor prevents manual process errors

The separator will emit an alarm sound and corresponding text prompt when there is any misaligned of anticoagulant. If this occurs the system is unable to carry out the next operation, which completely eliminates the risk of infusion error, and avoids any accident that endangers the safety of the plasma donor.



### Comprehensive monitoring surveillance system

All-directional multi-angle monitoring plasma collection process. Exclusive design of blood pump and anticoagulation pump. Adaptive compensation function is more compatible with consumables from different manufacturers. No wearing parts. Stable flow. Accurate control of blood cell access ratio. Multi-level alarm system can find any errors.



### Maintain & Protect Blood

Centrifuge cup adopts new patented technology to gently protect blood activity so that blood is safer.



### Compatible with accurate capacity optimization

It can be used with 160ml anticoagulant bags to accurately match actual needs, which means cost reduction and environmentally friendly improvements. Consumables are versatile and compatible with multiple models.

## Specifications

Model	Power supply (V/Hz)	Exterior dimensions (W*D*H) (mm)	Gross weight (kg)
XJ-II	220-/50	540*510*770	29

Parameters	Amount collected per cycle (g)	Total plasma collection (g)	Pump speed (ml/min)	Return speed (ml/min)	Anticoagulant (Citrate) to whole blood ratio	Centrifuge speed (r/min)
Range	0-300	0-1000	20-100	20-100	1:12-1:16	7000
Preset	230	600	80	80	1:16	7000
Precision	1	1	≤2	≤2	<1	≤2.5%

This product is composed of a mainframe (Centrifuge, blood pump, anticoagulant pump, weighing scale, display screen, air detector, pressure detector, control panel) and a pressure cuff, excluding the matching disposable pipe consumables.



# Plasma Blast Freezer

Mainly applicable to the quick-frozen treatment of plasma products in blood stations or medical institutions.



XSD-24FL

## Features

- Traceability of each freezing cycle
- Maximum freezing efficiency
- Able to freeze all types and different sized plasma bags
- Easy-to-use interface
- Fast pre-cooling process
- Pneumatic lift
- Rollable, ready-to-plug in or external solution
- Night storage control
- Stainless steel plates
- Air cooled solutions

## Performance Curve

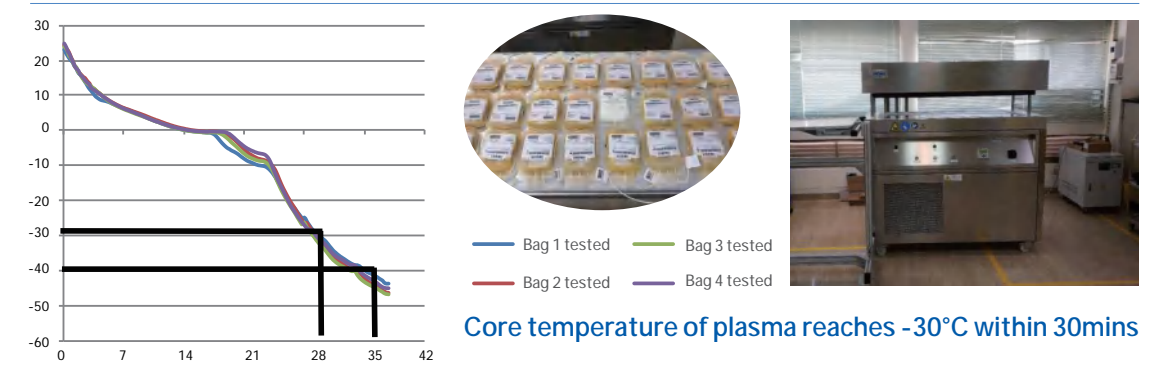

## Specifications

Model	Climate type	Power supply	Freezing capacity	Cooling method	Power cord	Dimension (head cover open) (mm)	Dimension (head cover close) (mm)	G.W/N.W (kg)
XSD-24FL	N	3N 400V/50hz/60hz	16 bags of 1000ml plasma or 24 bags of 500ml plasma	Forced air cooling	Crimp PTB	1455*915*1575	1455*915*1375	480/550

## Standard Parts List

Picture	Description	Basic Solution	Premium Solution	List of Configuration	Features & Functions
	Blast Freezer	●	●	1. XSD-24FL Blast Freezer 2. Analog sensor × 1 3. User's Manual × 1 4. Plug-in power cord × 1 5. Host computer software × 1 6. Dummy bag × 2	1. Rapid freezing of plasma, defrosting and locking 2. Pulls down the central temperature of blood bag to -30°C within 30mins 3. Standard software for host computer, to support query and printing of refrigeration data

## Optional Parts List

Picture	Description	Basic Solution	Premium Solution	List of Configuration	Features & Functions
	Scanner	●	●	Wireless scanner × 1	1. Enables the user to input the barcode of blood bag 2. Wireless device for more convenient operation 3. Ensures accurate and quick scanning
	Pallet Cart	○	●	Pallet cart for plasma transfer × 1	1. Made of aluminum alloy sections, firm and durable 2. Universal wheels, for convenient operation
	Tray	○	●	Tray for plasma transfer × 1	1. Made of aluminum to ensure high thermal conductivity 2. Put in and take out conveniently and effectively plasma by using the tray
	Analog Sensor	○	●	Analog sensor × 1	Supports the accurate regulation of blood bag
	Dummy Bag	○	●	Dummy bag × 1	Equipped with internal temperature measuring tube, convenient for determining the temperature at the center of blood bag

# Plasma Blast Freezer

Mainly applicable to the quick-frozen treatment of plasma products in blood stations or medical institutions.







XSD-48WFL

## Ergonomic Design

- 
**Flexible set up**  
 The storage temperature, freezing time, and defrosting time can be flexibly set as required
- 
**Simple operation**  
 All pre-cooling, freezing, defrosting procedures are controlled by PLC control module, simple operation, avoid wrong operation, ensure plasma safety
- 
**Rapid-freezing tray design**  
 Rapid-freezing tray design, not only to improve the efficiency of plasma rapid-freezing, but also easy to save labor
- 
**Electric lifting system**  
 Height control is more accurate and quieter than pneumatic lifting system
- 
**Password protection**  
 Parameter setting is password protected to ensure plasma safety
- 
**Friendly interface**  
 Friendly interface display design, clearer temperature observation

## Product Advantages

- 
**Low rapid-freezing temperature**  
 Rapid-freezing temperature can be reduced to -60°C, superior performance
- 
**Data is printable and the information traceable**  
 Plasma storage data and corresponding curves can be exported via USB, which is convenient for information traceability
- 
**Precise temperature control, control precision 1°C**  
 PLC control module, the system is stable and reliable, temperature control precision 1°C, to ensure the safety of plasma
- 
**Plate Rapid-Freezing, efficient Cooling**  
 The central temperature of full-load plasma can be quickly frozen to below -30°C within 45 minutes, which effectively guarantees the activity of factor VIII
- 
**Efficient core components, energy saving**  
 High efficiency compressor and dual-cooling system, better performance; Hydrocarbon refrigerant, energy saving and environmental protection

## Optional Accessories



Trolley

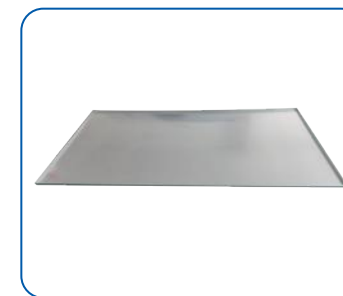

Tray

## Temperature Curve

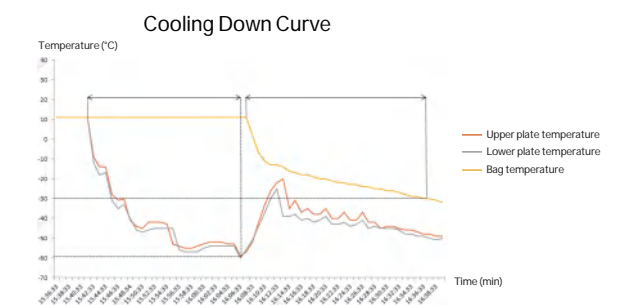

## Specifications

Model	Cooling Type	Power Supply	Cooling Method	Power Cord
XSD-48WFL	Plate contact quick-freezing	3N 380V-50HZ/60HZ	Forced air cooling	Plug and play

External Dimensions (mm)		Weight (kg)		Plasma Bag Capacity		
Indoor machine	Outdoor machine	Indoor machine	Outdoor machine	1000ml bag	350ml bag	250ml bag
2040*880*1895	1500*860*1850	320	360	32	80	80

Product appearance and specifications are subject to change without notice

# Plasma Blast Freezer

Mainly applicable to the quick-frozen treatment of plasma products in blood stations, plasma stations or medical institutions



XSD-24WFL

## Ergonomic Design



### Rapid-freezing tray design

Rapid-freezing tray design, not only to improve the efficiency of plasma rapid-freezing, but also reduces personnel hours



### Simple operation

All pre-cooling, freezing, defrosting procedures are controlled by PLC control module, simple operation, avoid errors and ensures plasma safety



### Electric lifting system

Height control is more accurate and quieter than pneumatic lifting system



### Password protection

Parameter setting is password protected to ensure plasma safety



### Flexible setup

The storage temperature, freezing time, and defrosting time can be flexibly set as required



### User-friendly interface

Easy to use and view temperature data via clear and intuitive interface

## Product Advantages



### Plate rapid-freezing

Contact refrigeration of upper and lower cold plates. Blood bags are placed between the upper and lower cold plates to achieve rapid freezing through contact and heat conduction. The appearance of quick-frozen blood bags is smooth



### Double stage cooling system

The refrigeration efficiency is 20% higher than that of single stage. Compared with single-stage compressor, double-stage compressor is more stable, more efficient and has a faster cooling speed at low temperature



### Split-style design

Placing the fan and compressors outdoors reduces the noise and heat output for an improved operator environment



### Intelligent screen

The 10-inch touch screen is convenient to view the temperature curve and data, record the rapid-freezing time in real time, and adjust the temperature parameters through the display screen, which is efficient and quick

## Cooling Down Curve

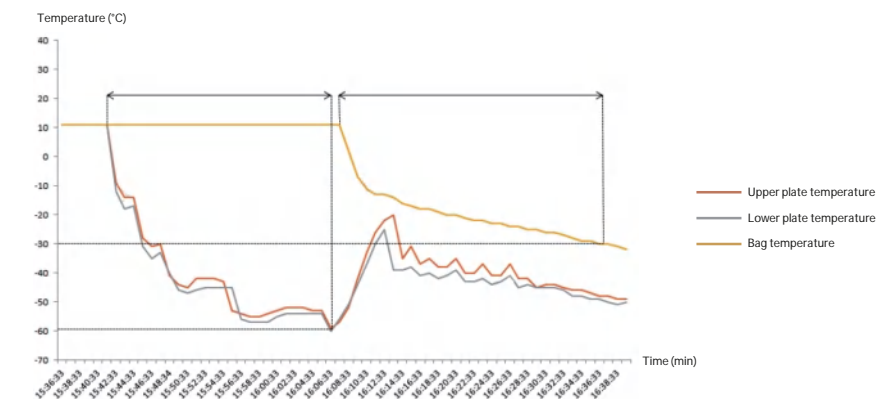

## Specifications

Model	Rapid-cooling Type	Power Supply (V/Hz)	Cooling Method	Power Cord	Exterior Dimensions (W*D*H)(mm)	Weight (Kg)
XSD-24WFL	Plate contact quick-freezing	3N 380-50/60	Forced air cooling	Plug and play	(Indoor machine / Outdoor machine) 1455*915*1465 1340*760*1640	(Indoor machine / Outdoor machine) 320/360

\*Haier Biomedical reserves the right to change products and specifications without prior notice.



# Platelet Incubator with Agitator

This incubator includes an integrated platelet agitator and is designed to create the optimal storage environment of platelets after collection. Suitable for hospitals, blood stations and research applications.



HXZ-149



HXZ-1369

## Product Performance

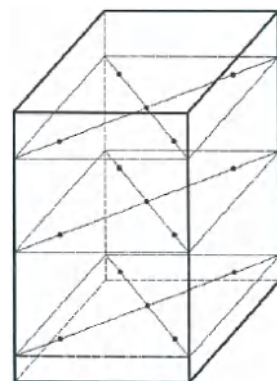

HXZ-149 15 test points

HXZ-149 Running temperature curve (Empty loaded)

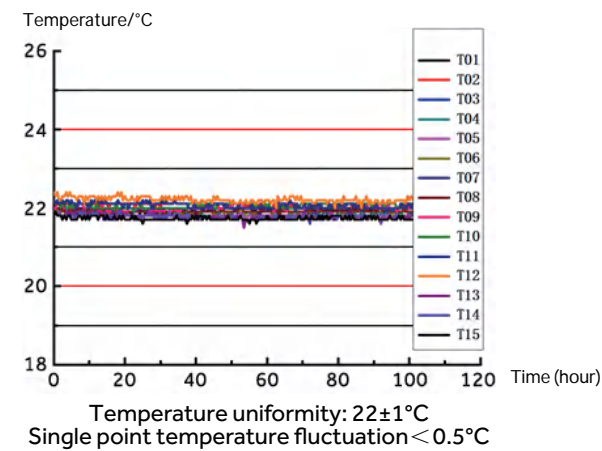

## Product Advantages



### Data Traceability

- Real-time temperature monitoring, records and stores historical data, alarm records and events
- USB interface, convenient and safe data transfer



### Energy Saving

Semiconductor temperature control technology, PID algorithm adjustment, energy saving 30% than the traditional compressor



### Multiple Alarms

Multiple alarms including over temperature alarm, power failure alarm, sensor failure alarm, door ajar alarm, low battery alarm, abnormal alarm of oscillating motor, remote alarm ensures maximum safety



### Superior Insulation Performance

60mm thickened foam layer. In the event of a power failure within a 25°C ambient and an empty load, the warm up time from 22°C to 24°C in the center of the chamber is more than 4 hours



### Reliable Oscillation

The agitator mechanism is equipped with an alarm and calibration device to ensure platelet quality



### Precise Temperature Control

Semiconductor temperature control, internal temperature is maintained at 22°C±1°C



### Low Noise

Semiconductor and EBM oscillating motor provide a quiet working environment



### Ultraviolet Disinfection

The UV disinfection function helps maintain a sterile environment

## Specifications

Model	HXZ-149	HXZ-1369
Temperature (°C)	22 ± 1	22 ± 1
Oscillation Range (mm)	50	50
Oscillation Frequency (times/min)	60	60
Power Supply (V/Hz)	220/50	220/50
Exterior Dimensions (mm)	625*795*1050	1545*915*1945
Interior Dimensions (mm)	505*560*610	1425*680*1455
Effective Capacity (L)	149	1369
Tray	9	18
Maximum Storage Capacity (300ml blood bags)	36	216
Net Weight (kg)	114	345

\*Haier Biomedical reserves the right to change products and specifications without prior notice.

Vaccine Storage



# Smart Vaccine refrigerator

## Haier Smart Vaccine

Haier Biomedical developed the Smart Vaccination Solution, by improving the conventional vaccination process, adopting advanced refrigeration technology, automation and intelligent vaccine delivery by incorporating IoT technologies. By connecting and leveraging the existing digital outpatient service system, the vaccination process can be managed as follows:

- After the vaccination record is scanned, the IoT based vaccination refrigerator will automatically and immediately eject the required vaccine.
- A 'double check' scan of the medical code to confirm a "Correct" & "Valid" vaccine prior to patient administration.
- Standardised vaccination process produces zero error.
- The vaccination records will be uploaded in real-time to the system. Records are traceable, making it possible to trace a specific vaccine code back to a specific child.

## Smart Vaccine Safe Vaccination Solution

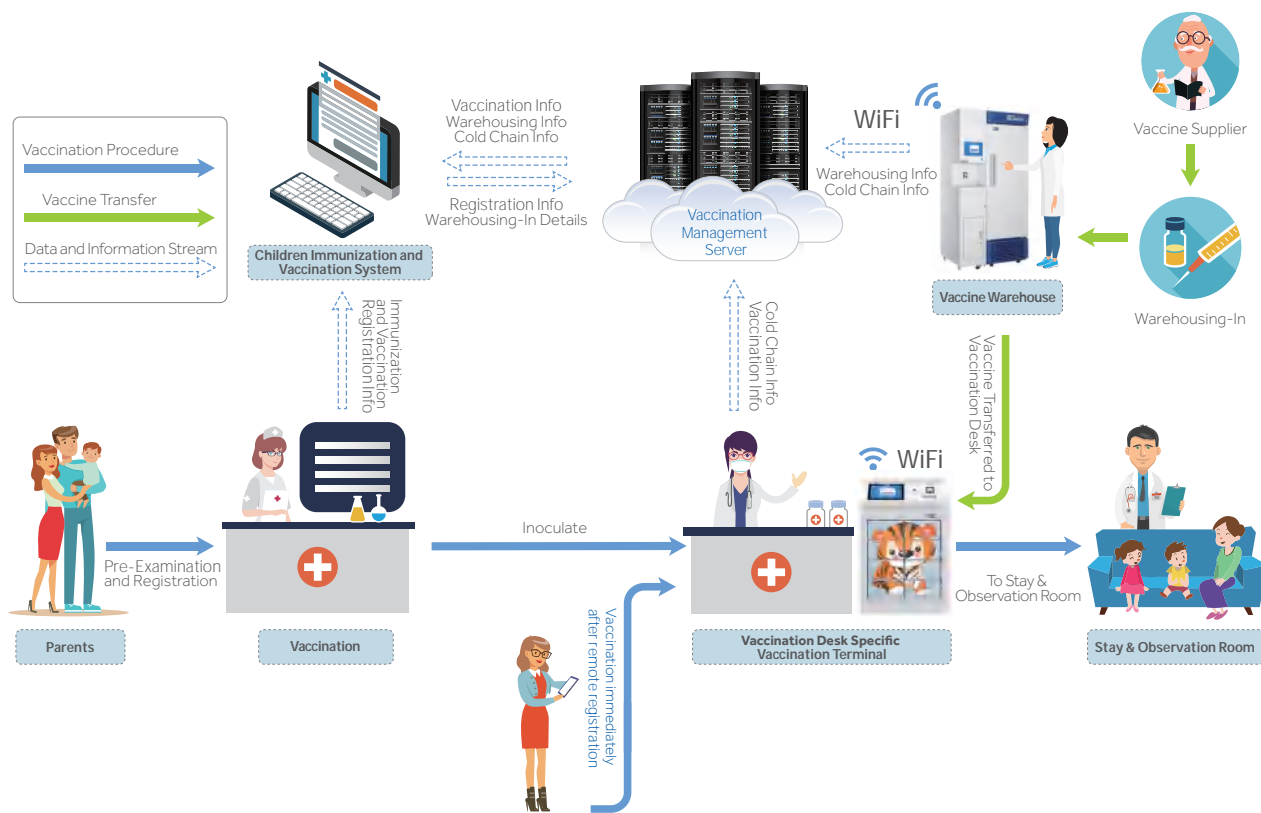

## Safe, Worry-free and Intelligent Vaccine Management

### 3 Key Advantages

- Right patient-vaccine information management system (VIMS) confirms correct patient required for the vaccination
- Right vaccine-vaccine is automatically selected and delivered and double-checked by VIMS to ensure right medicine can and should be administered
- Exchange of vaccine, child and vaccination information, end-to-end visibility and transparency, plus immediate freezing of vaccines upon expiration or in question, ensure the high reliability of the vaccination programme.

## Smart Vaccine Storage Solution

Vaccine storage management is an essential step to ensure vaccine safety. However, most of the vaccine storage refrigerators used by the vaccination stations are household refrigerators or ordinary medical refrigerators, without storage management functions, making it difficult to operate a first-in-first-out methodology. Haier's intelligent vaccine preservation refrigerator solves the problem of manual (pen and paper) vaccine management, which is time-consuming and laborious.

## Smart Vaccine Refrigerator

Smart Vaccine Preservation Refrigerator and Smart Vaccination Refrigerator are provided with a VIMS (Vaccine Information Management System) software to improve the vaccination experience.

- Smart Vaccine Preservation Refrigerator can improve the work efficiency of nurses by removing manual inventory-taking and warehouse operations by leveraging the classification based storage, electronic regulatory code based management, data and information stream management.



HYC-361

### Classification based storage

Each standard refrigerator is provided with 21 compartments in 7 layers. Each compartment can distinguish different lots of vaccines by applying specific first-in-first-out rules. Different kinds of vaccines can be stored upon such classification to effectively reduce the errors during the warehousing-in / out operations.



### The smallest package units

The warehousing-in/out operations are verified based on the electronic regulatory codes to realize the full digitalization and automation of vaccine management, and guarantee the accuracy and validity of vaccine storage data.



### Data and information streams

The data can be exchanged quickly between the vaccine warehouse and the vaccination desk. Vaccination program manager or disease control centre manager utilizes the vaccination management server, to monitor in real-time all vaccines stored by each vaccination station/centre.



- The Smart Vaccination Refrigerator, used at vaccination stations, can reduce the workload of nurses during the dispensing and checking of vaccines. The automated accurate vaccine dispensing, minimum temperature fluctuation, reconfirmation of vaccine information, electronic information system, integrated nurse station and other functions ensure zero vaccination error.



HYC-61

### Automated accurate vaccine dispensing

The vaccine will be ejected automatically after the Vaccination Record is scanned. The Regulatory Code will be scanned automatically to reconfirm the information of vaccine, including the inventory, expiration dates and cold chain early warnings. The time of dispensing can be shortened, and the rate of vaccination errors can be reduced effectively.

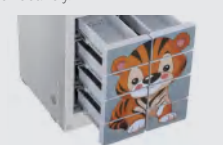

### Reduce temperature fluctuation

The refrigerator is divided into 8 independent chambers, and the small door of each chamber can be opened for taking out the vaccine required as quick as possible, to minimize the door opening time. The internal temperature fluctuation can be minimized to ensure the safe storage of vaccines.



### A Double Check

The warehousing-in/out and dispensing of vaccines can be verified by using the electronic regulatory codes. The vaccination can be conducted only after the vaccine to be used is verified by scanning the code. This function can guarantee the accurate vaccination effectively.



### Integrated nurse workstation

The queue management, vaccination management, vaccination information input, real-time cold chain control and authorization management are integrated into the vaccination desk vaccine refrigerator. Multiple tasks are centralized to streamline the overall management.

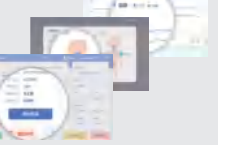



## Smart Vaccine refrigerator

247/248



## Specifications

Model		HYC-61	HYC-361	HYC-361 Scanner Cabinet	
Technical Data	Cabinet Type	upright	upright	upright	
	Climate Class	N	N	N	
	Cooling Type	Forced Air Cooling	Forced Air Cooling	/	
	Defrost Mode	Manual+ Auto defrost	Manual+ Auto defrost	/	
	Refrigerant	HC	HC	/	
	Sound Level (dB(A))	≤41	≤41	/	
Performance	Temperature Range (°C)	2-8	2-8	/	
Control	Controller	Microprocessor	Microprocessor	/	
	Display	10.1 inch touch screen	/	10.1 inch touch screen	
Electrical Data	Power Supply (V/Hz)	220/50	220/50	/	
	Power (W)	230	254	/	
	Electrical Current (A)	1.5	1.6	/	
	Power Consumption (kWh/24h)	1.8	1.5	/	
Construction	Capacity (L/Cu.Ft)	61/2.15	361/12.75	/	
	Net/Gross Weight (approx)	kg	80/90	116/139	36/42
		lbs	176/198	255.7/306.4	79.2/92.4
	Interior Dimensions (W*D*H)	mm	560*460*630	530*555*1380	/
		in	22*18.1*24.8	20.8*21.9*54.3	/
	Exterior Dimensions (W*D*H)	mm	600*600*935	980*680*1980	315*710*1965
		in	23.5*22.6*37.1	38.6*26.8*78	12.4*28*77.4
	Packing Dimensions (W*D*H)	mm	670*660*1110	1055*755*2110	420*744*2042
in		26.4*26*43.7	41.6*29.8*83.1	16.5*29.3*80.4	
Loading Quantities	Container load (20'/40'/40'H)	54/102/102	23/46/46	/	
Alarms	High/Low Temperature	Y	Y	/	
	Remote Alarm	Y	Y	/	
	Power Failure	Y	Y	/	
	Sensor Error	Y	Y	/	
	Door Ajar	/	Y	/	
Accessories	Caster	Y	Y	/	
	Foot	Y	Y	/	
	Porthole	/	Y	/	
	Shelves/Drawers	Y	Y	/	
	USB Interface	/	Y	/	
Certifications	Registration certification for medical equipment	Y	Y	/	
	CE	Y	Y	/	

Product appearance and specifications are subject to change without notice

## Solar Direct Drive Combined Refrigerator/Freezer

249/250

The combined refrigerator with freezer can be used to store vaccines, reagents and freeze ice packs. Suitable for remote and sunny regions where power shortages are common.



### Storage Security

- The anti-freeze function ensures the internal temperature of the cooling chamber is not lower than 0°C.
- Guarantees the safe storage of vaccines even in the event of a power failure. Under an ambient temperature of 43°C, the inner box temperature will be no more than 8°C in case of rainy or cloudy days for more than 121 hours (Autonomy time) and no more than 10°C after power outage for more than 160 hours (Holdover time).
- The freezing chamber can freeze 2.08kg of ice every day, with storage of 10.68kg in total.
- Solar powered temperature display indicates clearly the internal temperature.
- Lockable catch designed for padlock for added security
- The cooling chamber meets the A level WHO requirements for anti-freezing protection.



### Temperature Control

Microprocessor Control; accurate and precise temperature control



### Ergonomic Design

- Equipped with USB charging socket, allows users to charge their mobile phone, etc.
- Eliminate storage batteries and only provide solar energy power, which is better for the environment.
- Even when powered off the temperature display screen remains illuminated.
- The refrigerating chamber and freezing chamber both have separate refrigerating systems; the two independent cooling systems ensure safety of the vaccine storage.
- Sensor error alarm.
- Low noise.

## Specifications

	Model	HTCD-160	
Technical Data	Cabinet Type	Upright	
	Ambient Temperature (°C)	5-43	
	Cooling Type	Direct cooling	
	Defrost Mode	Manual	
	Refrigerant	HC	
	Sound Level (dB(A))	38	
Performance	Temperature Range (°C)	Freezer ≤-10 Refrigerator: 2-8	
	Waterpack Storage Capacity (kg)	10.68	
	Waterpack Freezing Capacity (kg/24h)	2.08	
	Freezer Protection Level	A	
Control	Controller	Microprocessor	
	Display	Solar LED Temperature Display	
Electrical Data	Power supply (V)	24	
	Maximal Current (A)	9	
	Energy Consumption: Stable Running (kWh/24h)	0.86	
	Energy Consumption: Cool Down Test (kWh/24h)	0.86	
	Holdover time at 43°C	160hrs8mins	
	Holdover time at 32°C	230hrs10mins	
	Autonomy Time at 43°C	121hrs27mins	
	Solar Radiation Reference Period (kWh/m <sup>2</sup> /day)	3.5	
Construction	Vaccine Storage Capacity (L/Cu.Ft)	100/3.5	
	Gross Volume (L/Cu.Ft)	Refrigerator: 120/4.2 Freezer: 40/1.4	
	Net/Gross Weight (approx)	kg	170/197
		lbs	374.8/434.3
	Interior Dimensions (W*D*H)	mm	Cooling Chamber: 545*500*530 Freezer Chamber: 560*520*150
		in	Cooling Chamber: 21.5*19.7*20.9 Freezer Chamber: 22.0*20.5*5.9
	Exterior Dimensions (W*D*H)	mm	865*825*1700
		in	34.1*32.6*66.9
	Packing Dimensions (W*D*H)	mm	985*920*1860
		in	38.8*36.2*73.2
Loading Quantities	Container Load (20'/40'/40'H)	12/24/24	
Alarm	Sensor Error	Y	
Accessories	Shelves	2(Refrigerator Room)	
	Data Logger	Y	
Certifications	CE	Y	
	WHO/PQS	Y	

Product appearance and specifications are subject to change without notice

# Solar Direct Drive Combined Refrigerator/Freezer

251/252

The combined refrigerator with freezer is designed to store vaccines, reagents and to freeze ice packs. Suitable for remote and sunny regions where power shortages are common. Freezers are only designed to freeze the ice packs and not applicable for the storage of vaccines.



HTCD-90



## Temperature Control

- Electronic temperature controller, digital temperature display, the display precision is 0.1°C and the control range is 2~8°C
- Solar energy temperature display system, without the need for a battery backup system



## High Performance

- World Health Organization Certified (PQS certification)
- Class A anti-freeze
- Low temperature thermal compensation to prevent vaccine freezing
- 140mm insulation provides excellent thermal efficiency
- Broad working ambient temperature range of 5~43°C, outstanding performance
- Internal and external double-door designs to ensure superior insulation performance



## Ergonomic Design

- Intelligent control
- The height of the temperature display screen is moderate, and the inner temperature can be checked at any time
- Safety door lock
- Low DC voltage ensures personal safety
- Plug-and-play type quick plug, positive and negative pole error-proof
- External door handle with door lock design to prevent random opening of the door to ensure vaccine safety
- Built-in handgrips on both sides of the cabinet facilitate overall movement
- The daily freezing volume of the freezer is 2.4kg, meeting the daily requirement



## Safety System

- Sensor error alarm, high and low temperature alarm
- Alarm mode: sound buzzer alarm and light flashing alarm
- Key components such as compressors and fans are designed for purpose to ensure the reliability and safety of stored items



## Environmental Protection

- Environmentally friendly hydrocarbon refrigerant R600a and foam material LBA
- The shell is coated with cold rolled steel plate, and the inner liner is made of 1.0mm alumina, easy to recycle
- Ultra low GWP value
- Without any battery

## Specifications

	Model	HTCD-90	
Technical Data	Cabinet Type	Chest	
	Ambient Temperature (°C)	5-43	
	Cooling Type	Direct cooling	
	Defrost Mode	Manual	
	Refrigerant	HC	
	Sound Level (dB(A))	< 38	
Performance	Temperature Range (°C)	Freezer ≤-10 Refrigerator: 2-8	
	Waterpack Storage Capacity (kg)	12.52	
	Waterpack Freezing Capacity (kg/24h)	2.43	
	Freezer Protection Level	A	
Control	Controller	Microprocessor	
	Display	Solar LED Temperature display	
Electrical Data	Power supply (V)	24	
	Maximal Current (A)	7	
	Energy Consumption: Stable Running (kWh/24h)	0.86	
	Energy Consumption: Cool Down Test (kWh/24h)	0.81	
	Holdover time at 43°C	137hrs47mins	
	Holdover time at 32°C	169hrs6mins	
	Autonomy Time at 43°C	114hrs 56mins	
	Solar Radiation Reference Period (kWh/m <sup>2</sup> /day)	3.5	
Construction	Vaccine Storage Capacity (L/Cu.Ft)	37.5/1.3	
	Gross Volume (L/Cu.Ft)	Refrigerator: 58/2.1 Freezer: 32 /1.1	
	Net/Gross Weight (approx)	kg	83/113
		lbs	183.0/250.0
	Interior Dimensions (W*D*H)	mm	Cooling Chamber: 270*345*555 Freezer Chamber: 170*370*555
		in	Cooling Chamber: 10.6*13.6*21.9 Freezer Chamber: 6.7*14.6*21.9
	Exterior Dimensions (W*D*H)	mm	1128*720*875
		in	44.4*28.3*34.3
	Packing Dimensions (W*D*H)	mm	1190*770*1080
		in	46.9*30.3*42.5
Loading Quantities	Container Load (20'/40'/40'H)	26/56/56	
Alarm	Sensor Error	Y	
Accessories	Baskets	2	
	Data Logger	Y	
Certifications	CE	Y	
	WHO/PQS	Y	

Product appearance and specifications are subject to change without notice



# Solar Direct Drive Vaccine Refrigerator

Applicable for the storage of biological products and items that need to be stored under the condition of 2-8°C within pharmacies, pharmaceutical factories, epidemic prevention stations, health centers and hospitals as key examples.



HTC-40/110/112

## Temperature Control

- Electronic temperature controller, digital temperature display, the display precision is 0.1°C and the control range is 2°C-8°C
- Solar power temperature display system, without the need of battery

## Ergonomic Design

- Intelligent control, no adjustment required
- The height of the temperature display screen is moderate, and the inner temperature can be checked at any time
- Safety door lock
- Low DC voltage ensures personal safety
- Plug-and-play type quick plug, positive and negative pole error-proof
- External door handle with door lock design to prevent random door to ensure vaccine safety
- Built-in handgrips on both sides of the box body facilitate overall movement

## Superior Performance

- World Health Organization Certified (PQS certification)
- Class A antifreeze
- Excellent hold-over times ensure the safety of vaccines
- Low temperature thermal compensation to prevent vaccine freezing
- 140mm insulation provides excellent thermal efficiency
- Wide working ambient temperature range of 5-43°C
- Internal and external double door design, better thermal insulation performance

## Safety System

- Sensor error alarm, high and low temperature alarm
- Alarm mode: sound buzzer alarm and light flashing alarm
- Key components like compressors and fans are designed for purpose to ensure reliability and safety of stored items

## Environmental Protection

- Environmentally friendly hydrocarbon refrigerant R600a and foam material LBA
- The shell is coated with cold rolled steel plate, and the inner liner is made of 1.0mm alumina, which is easy to recycle
- Ultra low GWP value
- Don't use any batteries

## Specifications

Model	HTC-40	HTC-110	HTC-112		
Technical Data	Cabinet Type	Chest	Chest	Chest	
	Ambient Temperature (°C)	5-43	5-43	5-43	
	Cooling Type	Direct cooling	Direct cooling	Direct Cooling	
	Refrigerant	HC	HC	HC	
	Sound Level (dB(A))	<30	<30	<30	
Performance	Temperature Range (°C)	2-8	2-8	2-8	
	Freezer Protection Level	A	A	A	
Control	Controller	Microprocessor	Microprocessor	Microprocessor	
	Display	Solar LED temperature display	Solar LED temperature display	Solar LED temperature display	
Electrical Data	Power supply (V)	24	24	24	
	Maximal Current (A)	5	5	5	
	Energy Consumption: Stable Running (kWh/24h)	0.69	0.58	0.59	
	Energy Consumption: Cool Down Test (kWh/24h)	0.71	0.62	0.62	
	Holdover time at 43°C	122hrs18mins	106hrs17mins	/	
	Holdover time at 32°C	162hrs36mins	152hrs28mins	/	
	Autonomy Time at 43°C	117hrs18mins	96hrs24mins	92hrs46mins	
	Solar Radiation Reference Period (kWh/m <sup>2</sup> /day)	3.5	3.5	3.5	
	Vaccine Storage Capacity (L/Cu.Ft)	22.5/0.8	59/2.08	75/2.65	
	Gross Volume (L/Cu.Ft)	40/1.4	110/3.88	110/3.88	
Construction	Net/Gross Weight (approx)	kg	57/82	75/105	75/105
		lbs	125.6/180.7	165/231.5	165/231.5
	Interior Dimensions (W*D*H)	mm	200*345*555	545*345*555	545*345*555
		in	7.9*13.6*21.9	21.5*13.6*21.9	21.5*13.6*21.9
	Exterior Dimensions (W*D*H)	mm	788*720*875	1128*720*875	1128*720*875
		in	31.0*28.3*34.4	44.4*28.3*34.4	44.4*28.3*34.4
Packing Dimensions (W*D*H)	mm	850*770*1080	1190*770*1080	1190*770*1080	
	in	33.4*30.3*42.5	46.9*30.3*42.5	46.9*30.3*42.5	
Loading Quantities	Container Load (20'/40'/40'H)	36/78/78	26/56/56	26/56/56	
Alarm	Sensor Error	Y	Y	Y	
Accessories	Baskets	2	4	4	
	Data Logger	Y	Y	Y	
Certifications	CE	Y	Y	Y	
	WHO/PQS	Y	Y	Y	

Product appearance and specifications are subject to change without notice

# Solar Direct Drive Vaccine Refrigerator

255/256

Applicable for the storage of vaccines and reagents within clinics, health centres, hospitals, public health and research organisations in remote and sunny regions where power shortages are common.



HTC-120

HTC-240



## Ergonomic Design

- Intelligent control
- High performance insulation with superior thermal efficiency
- Safety door lock
- Low DC voltage ensures personal safety



## Temperature Control

- Electronic temperature controller, digital temperature display, the display precision is 0.1°C and the control range is 2°C-8°C
- Low temperature thermal compensation to prevent vaccine freezing



## Safe and Reliable

- Plug-and-play type quick plug, positive and negative pole error-proof
- Solar powered display panel shows refrigerator and freezer interior temperature without the need for a battery backup



## Superior Insulation Performance

- World Health Organization Certified (PQS certification)
- Excellent autonomy time ensures the safety of vaccines
- 140mm insulation provides excellent thermal efficiency
- Broad working ambient temperature range of 5-43°C
- Door construction, seals and door handles maximizes door sealing effectiveness to reduce thermal loss



## Safety System

- Sensor error alarm, high and low temperature alarm
- Alarm mode: sound buzzer alarm and light flashing alarm
- Key components like compressors and fans are designed for purpose to ensure reliability and safety of stored items

## Specifications

Model	HTC-120	HTC-240		
Technical Data	Cabinet Type	Upright	Upright	
	Ambient Temperature (°C)	5-43	5-43	
	Cooling Type	Direct Cooling	Direct Cooling	
	Defrost Mode	No electric heating defrost	No electric heating defrost	
	Refrigerant	HC	HC	
Performance	Sound Level (dB(A))	≤43	≤43	
	Temperature Range (°C)	2-8	2-8	
Control	Freezer Protection Level	A	A	
	Controller	Microprocessor	Microprocessor	
Electrical Data	Display	Solar LED Temperature display	Solar LED Temperature display	
	Power supply (V)	24	24	
	Maximal Current (A)	5	5	
	Energy Consumption: Stable Running (kWh/24h)	0.44	0.35	
	Energy Consumption: Cool Down Test (kWh/24h)	0.48	0.54	
	Autonomy Time at 43°C	112hrs24mins	95hrs23mins	
	Autonomy Time at 32°C	183hrs20mins	151hrs10mins	
	Solar Radiation Reference Period (kWh/m <sup>2</sup> /day)	3.5	3.5	
Construction	Vaccine Storage Capacity (L/Cu.Ft)	100/3.5	200/7.1	
	Gross Volume (L/Cu.Ft)	120/4.2	240/8.5	
	Net/Gross Weight (approx)	kg	130/160	150/185
		lbs	286/352	330/407.9
	Interior Dimensions (W*D*H)	mm	530*500*530	530*500*960
		in	20.9*19.7*20.9	20.9*19.7*37.8
	Exterior Dimensions (W*D*H)	mm	865*825*1422	865*825*1815
in		34*32*56	34*32*71	
Packing Dimensions (W*D*H)	mm	980*920*1585	980*920*1980	
	in	38.6*36.2*62.4	38.6*36.2*78	
Loading Quantities	Container Load (20'/40'/40'H)	12/24/24	12/24/24	
Alarm	Sensor Error	Y	Y	
Accessories	Baskets	Y	Y	
	Shelves	3	4	
	Data Logger	Y	Y	
Certifications	CE	Y	Y	
	WHO/PQS	Y	Y	

Product appearance and specifications are subject to change without notice

## Solar Direct Drive Vaccine Freezer

257/258

This product is designed to freeze ice packs in remote and sunny regions where power shortages are common.

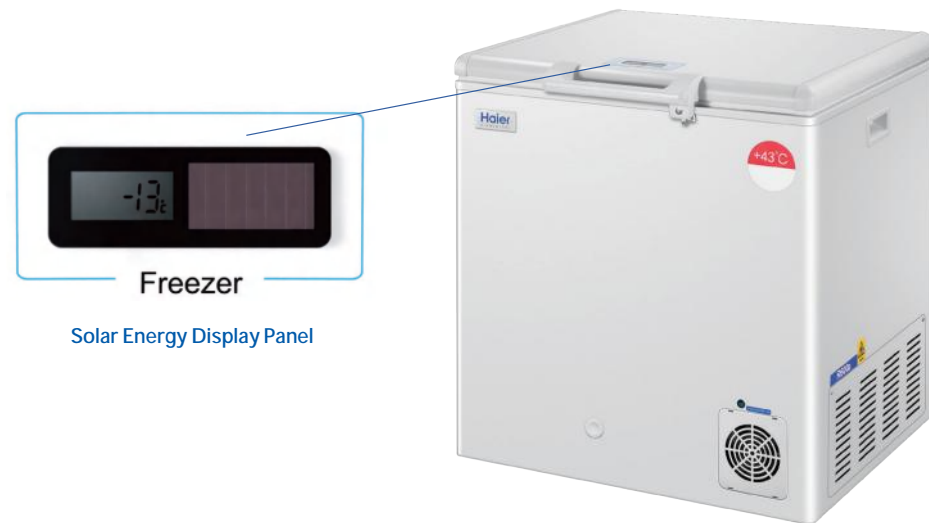

HTD-40



## High Performance

- World Health Organization Certified (PQS certification)
- Equipped with ice pack pressing device, enabling the ice-pack plastered to the liner, speed up the water pack freezing
- The thickness of insulation layer is 140mm to better store the frozen ice-packs
- Broad working ambient temperature range of below 43°C, outstanding performance
- Internal and external double door design, superior insulation performance



## Environmental Protection

- Environmentally friendly hydrocarbon refrigerant R600a and foam material LBA
- The shell is coated with cold rolled steel plate, and the inner liner is made of 1.0mm alumina, which is easy to recycle.
- Ultra low GWP value
- Without any battery



## Ergonomic Design

- Intelligent control
- The height of the temperature display screen is moderate, and the inner temperature can be checked at any time
- Safety door lock
- Low DC voltage ensures personal safety
- Plug-and-play type quick plug, positive and negative pole error-proof
- Built-in handgrips on both sides of the box body facilitate overall movement
- Compressor indicator light, indicating the system work status
- Two-chamber design: Ice pack freezer and ice pack storage chamber



## Temperature Control

- Electronic temperature controller, digital temperature display, the display precision is 0.1°C, during the day the temperature can reach -10°C
- Solar energy temperature display system, driven by natural light



## Safety System

High performance key components (compressor, fan, controller, etc.), safe and reliable

## Specifications

	Model	HTD-40	
Technical Data	Cabinet Type	Chest	
	Ambient Temperature (°C)	≤43	
	Cooling Type	Direct cooling	
	Defrost Mode	Manual	
	Refrigerant	HC	
	Sound Level (dB(A))	<30	
Performance	Temperature Range (°C)	<-10	
	Waterpack Storage Capacity (kg)	20	
	Waterpack Freezing Capacity (kg/24h)	2.4	
Control	Controller	Microprocessor	
	Display	Solar LED Temperature Display	
Electrical Data	Power supply (V)	24	
	Maximal Current (A)	5	
	Energy Consumption: Stable Running (kWh/24h)	0.46	
	Energy Consumption: Cool Down Test (kWh/24h)	0.50	
	Autonomy Time at 43°C	5 days	
	Solar Radiation Reference Period (kWh/m <sup>2</sup> /day)	3.5	
Construction	Gross Volume (L/Cu.Ft)	48/1.7	
	Net/Gross Weight (approx)	kg	65/85
		lbs	143.0/187.4
	Interior Dimensions (W*D*H)	mm	Waterpack Freezer: 135*370*310 Waterpack Storage Chamber: 265*370*555
		in	Waterpack Freezer: 5.3*14.6*12.2 Waterpack Storage Chamber: 10.4*0.6*0.5
	Exterior Dimensions (W*D*H)	mm	788*720*875
		in	31.0*28.3*34.3
	Packing Dimensions (W*D*H)	mm	850*770*1080
		in	33.4*30.3*42.5
	Solar Panel (L*W*D)	mm	1335*990*40
in		52.6*39.0*1.6	
Loading Quantities	Container Load (20'/40'/40'H)	36/78/78	
Alarm	Sensor Error	Y	
Accessories	Baskets	2	
Certifications	CE	Y	
	WHO/PQS	Y	

Product appearance and specifications are subject to change without notice



# Solar Direct Drive Blood Refrigerator

259/260

Applicable for storing wholeblood, medicines, biological products and other laboratory products that need to be stored at 4°C.

Suitable for the storage of blood and blood articles in areas that have power shortages.



HTXC-240



Lock Catch Designed to Match Padlock



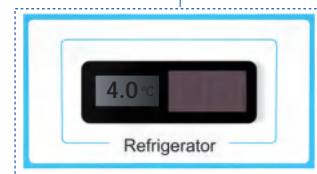

Handgrip



Display Panel

 It is equipped with 16 blood baskets, each basket can hold 12 blood bags, and a total of 192 blood bags can be stored (350ml blood bags)

 Excellent autonomy time ensures the safety of blood

 Solar direct drive refrigerator without battery

 Environmentally friendly hydrocarbon refrigerant R600a and foam material LBA

 Electronic temperature controller, digital temperature display, the display precision is 0.1°C and the control range is 2°C~8°C

 Broad working ambient temperature range of 5~43°C

 Vertical structure, first-in first-out, easy operation

 Automatic drainage design

## Specifications



Model		HTXC-120	HTXC-240	
Technical Data	Cabinet Type	Upright	Upright	
	Ambient Temperature (°C)	≤43	≤43	
	Cooling Type	Direct Cooling	Direct Cooling	
	Defrost Mode	No electric heating defrost	No electric heating defrost	
	Refrigerant	HC	HC	
	Sound Level (dB(A))	≤43	≤43	
Performance	Temperature Range (°C)	2-8	2-8	
	Freezer Protection Level	A	A	
Control	Controller	Microprocessor	Microprocessor	
	Display	Solar LED Temperature display	Solar LED Temperature display	
Electrical Data	Power supply (V)	24	24	
	Maximal Current (A)	5	5	
	Energy Consumption: Stable Running (kWh/24h)	0.44	0.35	
	Energy Consumption: Cool Down Test (kWh/24h)	0.48	0.54	
	Autonomy Time at 43°C	112hrs24mins	95hrs23mins	
	Autonomy Time at 32°C	183hrs20mins	151hrs10mins	
	Solar Radiation Reference Period (kWh/m <sup>2</sup> /day)	3.5	3.5	
Construction	Blood Storage Capacity (350ml Blood Bags)		108	192
	Gross Volume (L/Cu.Ft)		120/4.2	240/8.5
	Net/Gross Weight (approx)	kg	130/160	150/185
		lbs	286/352	330/407.9
	Interior Dimensions (W*D*H)	mm	530*500*530	530*500*960
		in	20.9*19.7*20.9	20.9*19.7*37.8
	Exterior Dimensions (W*D*H)	mm	865*825*1422	890*825*1815
		in	34*32*56	35*32*71
Packing Dimensions (W*D*H)	mm	980*920*1585	985*920*1980	
	in	38.6*36.2*62.4	38.8*36.2*78	
Loading Quantities	Container Load (20'/40'/40'H)	12/24/24	12/24/24	
Alarm	High/Low Temperature	Y	Y	
	Sensor Error	Y	Y	
Accessories	Shelves	3	4	
	Data Logger	Y	Y	
	Remote Temperature Monitoring Device(RTMD)	Optional	Optional	
Certifications	CE	Y	Y	
	WHO/PQS	Y	Y	

Product appearance and specifications are subject to change without notice

# Ice-Lined Refrigerator

The combined refrigerator with freezer is designed to store vaccines, reagents and to freeze ice packs. Suitable for vaccination stations, epidemic prevention stations, healthcare centers, pharmaceutical factories as key examples. Freezers are only designed to freeze the ice packs and not applicable for the storage of vaccines.

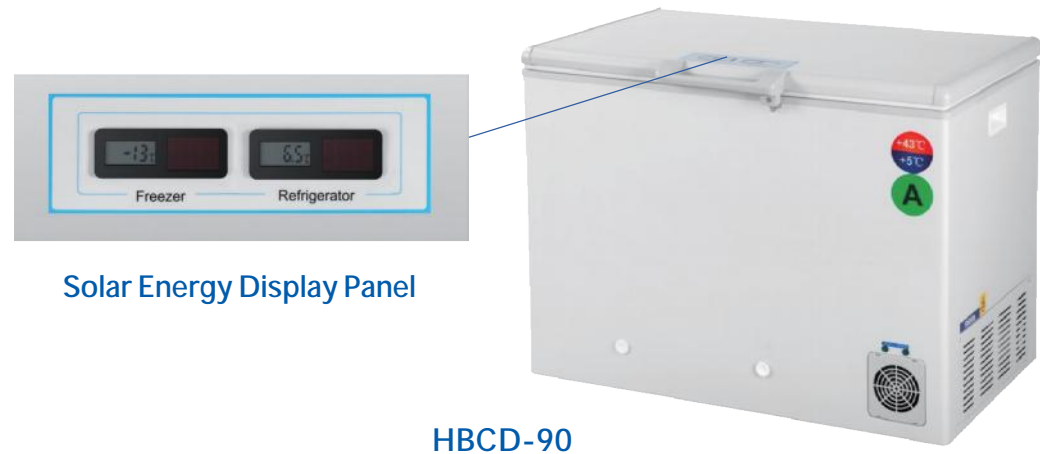

Solar Energy Display Panel

HBCD-90

**Temperature Control**

- Electronic temperature controller, digital temperature display, the display precision is 0.1°C and the control range is 2-8°C
- Solar powered display panel shows interior temperature through natural light sources

**Ergonomic Design**

- Intelligent control, no adjustment required
- The height of the temperature display screen is moderate, and the inner temperature can be checked at any time
- External door handle with door lock design to prevent random opening of the door to ensure vaccine safety
- Built-in handgrips on both sides of the cabinet facilitate overall movement

**Safety System**

- Sensor error alarm, high/low temperature alarm
- Alarm mode: sound buzzer alarm and light flashing alarm
- Key components such as compressors and fans are designed for purpose to ensure the reliability and safety of stored items

**Environmental Protection**

- Environmentally friendly hydrocarbon refrigerant R600a and foam material LBA
- The shell is coated with cold rolled steel plate, and the inner liner is made of 1.0mm alumina, easy to recycle
- Ultra low GWP value
- Without any battery

**Superior Performance**

- Complies with WHO PQS specification E003/RF03.4
- Super long holdover time to ensure vaccine safety
- The daily frozen ice volume of the freezer is 4.0KG, which can meet the daily use
- Broad working ambient temperature range of 5-43°C, outstanding performance

## Specifications

	Model	HBCD-90	
Technical Data	Cabinet Type	Chest	
	Ambient Temperature (°C)	5-43	
	Cooling Type	Direct Cooling	
	Defrost Mode	Manual	
	Refrigerant	HC	
	Sound Level (dB(A))	< 40	
Performance	Temperature Range (°C)	Freezer ≤-10 Refrigerator: 2-8	
	Waterpack Storage Capacity (kg)	16	
	Waterpack Freezing Capacity (kg/24h)	4	
	Freezer Protection Level	A	
Control	Controller	Microprocessor	
	Display	Solar LED Temperature display	
Electrical Data	Power Supply (V/Hz)	220-240/50	
	Power (W)	190	
	Electrical Current (A)	1	
	Power Consumption: stable running (kWh/24h)	0.9	
	Power Consumption: cool down test (kWh/24h)	1	
	Holdover Time at 43°C	63hrs48mins	
	Holdover Time at 32°C	132hrs21mins	
Construction	Vaccine Storage Capacity (L/Cu.Ft)	30/1.1	
	Gross Volume (L/Cu.Ft)	Refrigerator:42/1.5 Freezer:32/1.1	
	Net/Gross Weight (approx)	kg	105/135
		lbs	231/298
	Interior Dimensions (W*D*H)	mm	Refrigerator Chamber:279*273*556 Freezer Chamber:166*366*580
		in	Refrigerator Chamber:11*10.8*21.9 Freezer Chamber:6.5*14.4*22.8
	Exterior Dimensions (W*D*H)	mm	1128*717*872
		in	44.4*28.2*34.3
	Packing Dimensions (W*D*H)	mm	1190*770*1080
		in	47*30*42.5
Loading Quantities	Container Load (20'/40'/40'H)	26/56/56	
Alarm	High/Low Temperature	Y	
	Sensor Error	Y	
Accessories	Baskets	4	
	Data logger	Y	
	30 Days Temperature Logger	Optional	
	Automatic Voltage Stabilizer	Optional	
	Remote Temperature Monitoring Device (RTMD)	Optional	
Certifications	CE	Y	
	WHO/PQS	Y	

Product appearance and specifications are subject to change without notice

# Ice-Lined Refrigerator

263/264

Suitable for pharmacies, pharmaceutical factories, epidemic prevention stations, health centers, hospitals as key examples. Used to store biological products and items that need to be stored under the condition of 2~8°C.

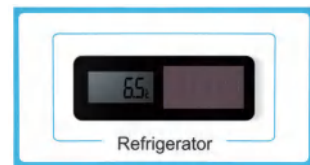

Solar Energy Display Panel



HBC-150/260/80



### Temperature Control

- Electronic temperature control, temperature digital display and the precision is 0.1°C, internal temperature range is 2°C~8°C
- Solar powered display panel shows interior temperature through natural light sources



### Safety system

- Sensor error alarm, high/low temperature alarm
- Alarm mode: sound buzzer alarm and light flashing alarm
- All independent components are securely earthed
- Key components such as compressors and fans are QC approved



### Superior performance

- World Health Organization Certified(PQS certification)
- Broad ambient temperature range of 5°C~43°C
- Broad voltage design, stable operation within ± 20% voltage range



### Ergonomic design

- Intelligent control, no adjustment required
- High performance insulation with superior thermal efficiency
- Safety door lock

## Specifications

Model		HBC-80		HBC-150		HBC-260	
Technical Data	Cabinet Type	Chest		Chest		Chest	
	Ambient Temperature (°C)	5-43		5-43		5-43	
	Cooling Type	Direct Cooling		Direct Cooling		Direct Cooling	
	Refrigerant	HC		HC		HC	
	Sound Level (dB(A))	<40		<40		<40	
Performance	Temperature Range (°C)	2-8		2-8		2-8	
	Freezer Protection Level	A		A		A	
Control	Controller	Microprocessor		Microprocessor		Microprocessor	
	Display	Solar LED Temperature Display		Solar LED Temperature Display		Solar LED Temperature Display	
Electrical Data	Power Supply (V/Hz)	220-240/50	220V-240V (50/60Hz)	220-240/50	220V-240V (50/60Hz)	220-240 (50/60)	
	Power (W)	110	140	120	150	165	
	Electrical Current (A)	0.9	1.3	1	1.5	1.3	
	Power Consumption:Stable Running(kWh/24h)	0.6	0.55	0.6	0.72	1.47	
	Power Consumption:Cool Down Test(kWh/24h)	0.7	0.65	0.7	0.76	1.62	
	Holdover Time at 43°C	59hrs58mins	57hrs34mins	60hrs50mins	57hrs55mins	62hrs	
	Holdover Time at 32°C	98hrs26mins		96hrs23mins		117hrs24mins	
	Vaccine Storage Capacity (L/Cu.Ft)	61/2.2		122/4.3		211/7.5	
	Gross Volume (L/Cu.Ft)	80/2.8		150/5.3		260/9.2	
	Construction	Net/Gross Weight (approx)	kg	85/110	105/140	160/200	
lbs			187.6/242.7	231.7/308.9	353/441.3		
Interior Dimensions (W*D*H)		mm	500*366*560	840*366*560	1359*366*560		
		in	19.7*14.4*22	33.1*14.4*22	53.5*14.4*22		
Exterior Dimensions (W*D*H)		mm	788*717*872	1128*717*872	1647*717*940		
		in	31*28.2*34.3	44.4*28.2*34.3	64.8*28.2*37		
Packing Dimensions (W*D*H)	mm	850*770*1080	1190*770*1080	1720*770*1080			
	in	33.5*30*42.5	47*30*42.5	67.7*30*42.5			
Loading Quantities	Container Load (20'/40'/40'H)	36/78/78		26/56/56		18/38/38	
Alarms	High/Low Temperature	Y		Y		Y	
	Sensor Error	Y		Y		Y	
Accessories	Foot	/		/		Y	
	Baskets(Standard/Max)	1/2		3/5		5/9	
	Data logger	Y		Y		Y	
	Automatic Voltage Stabilizer	Optional		Optional		Optional	
	Remote Temperature Monitoring Device(RTMD)	Optional		Optional		Optional	
Certifications	CE	Y		Y		Y	
	WHO/PQS	Y		Y		Y	

Product appearance and specifications are subject to change without notice



# Ice-Lined Refrigerator

This product is applicable for the storage of biological products and items that need to be stored under the condition of 2~8°C. This product is used by pharmacies, pharmaceutical factories, epidemic prevention stations, health centers and hospitals as key examples.



HBC-120



HBC-240



### Microprocessor Control System

- Microprocessor electronic temperature controller, LED temperature display, the temperature display precision is 0.1°C and the control range is 2°C~8°C
- Solar powered display panel shows refrigerator and freezer interior temperature



### Safe, Secure and Reliable

- Sensor error alarm, high and low temperature alarm
- Alarm mode: sound buzzer alarm and light flashing alarm
- All discrete units are properly grounded
- Key units like the compressor and the fan are safe and reliable



### Superior Performance

- International Health Organization Certification (PQS certification)
- Extra-long holdover time (It can maintain the interior temperature with only 8hrs power supply per day)
- Broad working ambient range of 5~43°C
- Operates within wide voltage range, ±20% volt



### Ergonomic Design

- Intelligent control
- High performance insulation layer with superior thermal insulation
- Ergonomic designed safety lock

## Specifications

Model		HBC-120	HBC-240	
Technical Data	Cabinet Type	Upright	Upright	
	Ambient Temperature (°C)	5~43	5~43	
	Cooling Type	Direct Cooling	Direct Cooling	
	Refrigerant	HC	HC	
Performance	Sound Level (dB(A))	<40	<40	
	Temperature Range (°C)	2~8	2~8	
Control	Freezer Protection Level	A	A	
	Controller	Microprocessor	Microprocessor	
Electrical Data	Display	Solar LED Temperature Display	Solar LED Temperature Display	
	Power Supply (V/Hz)	220~240/50/60	220~240/50/60	
	Power (W)	145	145	
	Electrical Current (A)	1	1	
	Power Consumption:Stable Running (kWh/24h)	0.35	0.35	
	Power Consumption:Cool Down Test (kWh/24h)	0.4	0.4	
	Holdover Time at 43°C	128hrs 48mins	87hrs14mis	
	Holdover Time at 32°C	185hrs	165hrs	
	Vaccine Storage Capacity (L/Cu.Ft)	100/3.6	200/7.2	
	Gross Volume (L/Cu.Ft)	120/4.3	240/8.5	
Construction	Net/Gross Weight (approx)	kg	128/160	152/186
		lbs	281.6/352	334.4/409.2
	Interior Dimensions (W*D*H)	mm	530*500*530	530*500*960
		in	20.87*19.69*20.87	20.87*19.69*37.8
	Exterior Dimensions (W*D*H)	mm	890*829*1425	890*829*1815
		in	35.04*32.64*56.10	35.04*32.64*71.46
Packing Dimensions (W*D*H)	mm	980*920*1585	980*920*1980	
	in	38.6*36.2*62.4	38.6*36.2*78	
Loading Quantities	Container Load (20'/40'/40'H)	12/24/24	12/24/24	
Alarms	High/Low Temperature	Y	Y	
	Sensor error	Y	Y	
Accessories	Foot/Caster	Y	Y	
	Shelves	3	4	
	Data logger	Y	Y	
	Automatic Voltage Stabilizer	Optional	Optional	
Certifications	Remote Temperature Monitoring Device (RTMD)	Optional	Optional	
	CE	Y	Y	
	WHO/PQS	Y	Y	

Product appearance and specifications are subject to change without notice

## Vaccine &amp; Icepack Freezer

267/268

This product is applicable for cryogenic storage of biological reagents in hospitals, CDC, health facilities and other units in areas with insufficient or unstable power supply.



HBD-86

HBD-265



## Refrigeration System

- High quality compressor
- CFC-free high-density foam insulation
- Optimized refrigeration system design



## Temperature Control

- Electronic temperature controller with digital display
- Internal temperature range is -15°C to -20 °C



## Ergonomic Design

- Safety lock to safeguard against unauthorized access
- Internal configuration suitable for various sizes of storage baskets
- Drainage port for ease of cabinet cleaning
- LCD temperature display



## Alarms

- Power failure alarm, high temperature alarm, sensor error alarm
- Two alarm modes: sound alarm and light alarm

## Specifications

Model	HBD-86	HBD-265		
Technical Data	Cabinet Type	Chest	Chest	
	Ambient Temperature	<43°C	<43°C	
	Cooling Type	Direct Cooling	Direct Cooling	
	Defrost Mode	/	Manual	
	Refrigerant	HC	HC	
	Sound Level (dB(A))	40.6	39.3	
Performance	Temperature Range (°C)	-15~-25	-15~-25	
Control	Controller	Microprocessor	Microprocessor	
	Display	LCD	LCD	
Electrical Data	Power Supply (V/Hz)	220~240(50/60)	220~240(50/60)	
	Power (W)	120	210	
	Electrical Current (A)	1.1	1.6	
	Power Consumption: Cool Down Test (kWh/24h)	0.98	1.43	
	Power Consumption: Stable Running (kWh/24h)	0.95	1.41	
	Holdover Time at 43°C	More than 7hrs (up to -5°C)	11hrs25min (up to -5°C)	
Construction	Gross Volume (L/Cu.Ft)	86/3	265/9.4	
	Net/Gross Weight (approx)	kg	65/90	135/160
		lbs	143/198	297/352
	Interior Dimensions (W*D*H)	mm	500*366*560	1359*366*560
		in	19.7*14.4*22	53.5*14.4*22
	Exterior Dimensions (W*D*H)	mm	788*717*872	1647*717*940
		in	31*28.2*34.3	64.8*28.2*37
	Packing Dimensions (W*D*H)	mm	850*770*1080	1720*770*1080
in		33.5*30*42.5	67.7*30*42.5	
Loading Quantities	Container Load (20'/40'/40'H)	36/78/78	18/38/38	
Accessories	Foot	/	Y	
	Baskets	3	9	
	Automatic Voltage Stabilizer	optional	optional	
Certifications	CE	Y	Y	
	WHO/PQS	Y	Y	

Product appearance and specifications are subject to change without notice

## Walk-In Cold/Freezer Room

269/270



Haier Biomedical walk-in cold rooms are for storage of vaccines and other temperature sensitive products. The complete unit is also designed for installations in housed areas such as warehouses to meet specified temperature standards. These units have been installed in India, Guinea, Syria, Pakistan, Burundi, Zimbabwe and other regions across the world.

## Specifications

Type	Freezer Room	Freezer Room	Cold Room	Cold Room	Cold Room	Cold Room	Cold Room	Combined Cold/Freezer Room	
								Cold Room	Freezer Room
Model	HRZK-40D	HRZK-20D	HRZK-10G	HRZK-15G	HRZK-20G	HRZK-30G	HRZK-40G	HRZK-40GD	
Defrost Mode	Electrical heating								
Refrigerant	CFC-Free								
Internal Temperature Range (°C)	-20	-20	2-8	2-8	2-8	2-8	2-8	2-8	-20
Evaporator Temperature (°C)	-25	-25	-7	-7	-7	-7	-7	-7	-25
Power Supply (V/Hz)	380/50	380/50	220/50	220/50	220/50	380/50	380/50	380/50	
Power (W)	5300	2630	1300	1750	1750	2520	2610	2520	2010
Refrigerating Output (W)	4200	2060	1560	2230	2230	2950	3250	2950	1580
Capacity (m³)	40	20	10	15	20	30	40	25	15
Condensation Temperature (°C)	43								
Density (Kg/Cbm)	40±2								
K-Value (m²K)	0.22								
Insulation Thickness (mm)	100								
Certification	-		WHO/PQS						

Product appearance and specifications are subject to change without notice

## Integral Cold Store Unit

- The cold room is suitable for a variety of applications; it can be used to freeze or refrigerate samples for healthcare, research, agriculture, and biotechnology purposes. In the walk-in cold room (WIC), the interior temperature can be controlled within a range of 2°C to 8°C. In the walk-in freezer (WIF), the temperature is set at -20°C.



## Features of the Cold Room

- The set point of the cold room has an adjustable range of 0°C to 10°C (or -15°C to -25°C for the Freezer Room) with a resolution of 0.1°C.
- High-efficiency CFC-free polyurethane insulation foamed into place. With a density of 42kg/m³, a thickness of 100mm and an insulation K-value of 0.22 W/(m²)(K) or better.
- Internal and exterior surfaces are made up of hot-dipped galvanized steel sheet, coated in a white polyester coating. The floor is clad with non-slip material.
- Rooms are equipped with tungsten lighting.
- Rooms are equipped with shelving systems on 3 of their walls.
- Dual refrigeration system – while one system is working, the other one is reserved as a back-up.
- Forced air-cooling system
- Door equipped with a lock and heavy-duty hinges, with an internal safety release.
- CFC-free refrigerant
- Automatic defrosting
- A manual change-over switch is offered as standard, an automatic change-over switch is available as an optional extra.
- Temperature recorder and audible alarm system.

## Technical Characteristics of the Refrigerating Unit

- An integrated condenser unit, called Mono block, integrating evaporator, condenser, compressor, electrical control units into one compact body, is used in cold storage rooms with temperature control of -5°C~5°C or -15°C~-20°C, in medical, clinical, agricultural and chemical industries where large scale cold storage is needed.
- Small compact structure.
- Comprises of TECUMSEH hermetic compressors, high efficient, in-grooved copper tube and aluminium fin heat exchangers and leading brand refrigeration parts.
- The electronic control boards manage following parameters: automatic temperature setpoint and control, electric heater defrosting, protection devices for over loading, over-heating, lack of phase, high and low pressure.
- Safe, easy to use and is economical, low cost installation and operation.

## Temperature Recorder

- Upper and lower limits +50°C to -30°C
- Accuracy ±1°C
- Resolution ±0.5°C
- Minimum acceptable recording period between chart changes is 7 days
- USB interface is included



## Cold Room

271/272

### Combined Cold Room

Applicable for storing large quantities of vaccines, reagents, medicines and other biological products. Suitable for CDCs, animal epidemic prevention and control centers, hospitals, biopharmaceutical companies, etc.

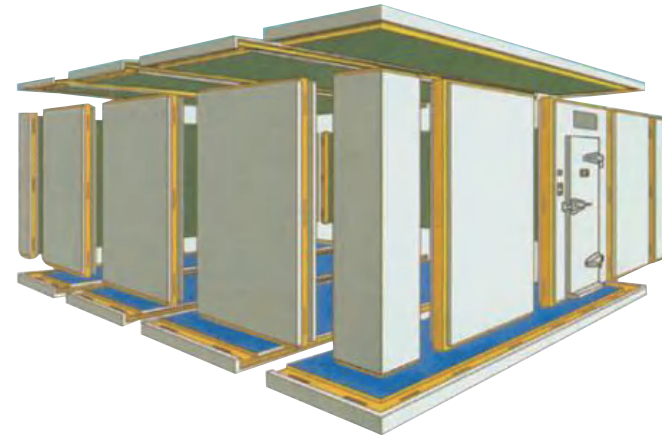

#### Technical Features:

- The integrated solution provider integrates cold storage, automation, informatization and environmental laboratory.

#### Environmental protection

- Uses R404a environmentally friendly refrigerant;
- Uses durable, environmentally-friendly poly-ethurane foam insulated walls to provide excellent insulation with a low ozone destruction coefficient.

#### Safety

- With equipment fault self-diagnosis function. With a variety of active protection and passive early warning functions, the operating status is monitored to ensure the safety of stored samples.

#### Modular

- The system is modular and solutions are customized according to individual requirements.

#### Energy saving

- The technology of liquid-subcooling and exhaust-precooling via defrosting water is adopted to save energy.

#### Smart

- The PLC control system can automatically control the start and stop of the refrigeration unit, the regular switching between the main and standby machines and the automatic fault switch. No manual operation is required for refrigeration and defrosting.

### Side Loading Cold Room

Applied to save vaccines, reagents, medicaments, biological products, etc., Suitable for community clinics, pharmacies, etc.



#### Technical Features:

- All-weather: 24-hour uninterrupted monitoring of the cold storage operation status to ensure the safety of samples;

## Solar Direct Driven Cold Room

- Whole process monitoring: production, transportation and storage
- Full coverage: network monitoring, real-time query, unified management
- Stable state change rate:  $\leq \pm 0.3^\circ\text{C}/10\text{h}$
- Temperature uniformity:  $\leq \pm 3^\circ\text{C}$
- Ultra-low noise: the noise of the outdoor unit is less than 50 decibels
- Exclusive perforated ceiling air supply design ensures rapid cooling and excellent temperature uniformity  $\pm 1^\circ\text{C}$
- Utilizes quick and effective hot fluoride defrosting method
- An electronic expansion valve accurately controls the storage temperature while ensuring the refrigeration system runs more energy efficiently



Applicable for storage of temperature-sensitive products such as large quantities of vaccines and medicines; National or regional vaccine centers, hospitals, biopharmaceutical and other industries;

#### Technical Features:

- Powered by solar photovoltaic power generation system, low operating cost.

- Solar direct drive refrigeration, no battery driven compressor; combined with ice lining technology, maintain the temperature in the cold room at  $2-8^\circ\text{C}$  throughout the day.
- Adopting PLC intelligent control, preferentially start the compressor of higher temperature cold storage box to ensure the uniformity of the room temperature.
- Power off and maintain  $2-8^\circ\text{C}$  for more than 48 hours at  $43^\circ\text{C}$  ambient temperature; it can last longer under low ambient temperature conditions.
- Low temperature protection function module (optional), can achieve  $5-43^\circ\text{C}$  wide temperature range operation.
- Optional 48V switching power supply can be connected to single-phase 110-220V AC power supply.

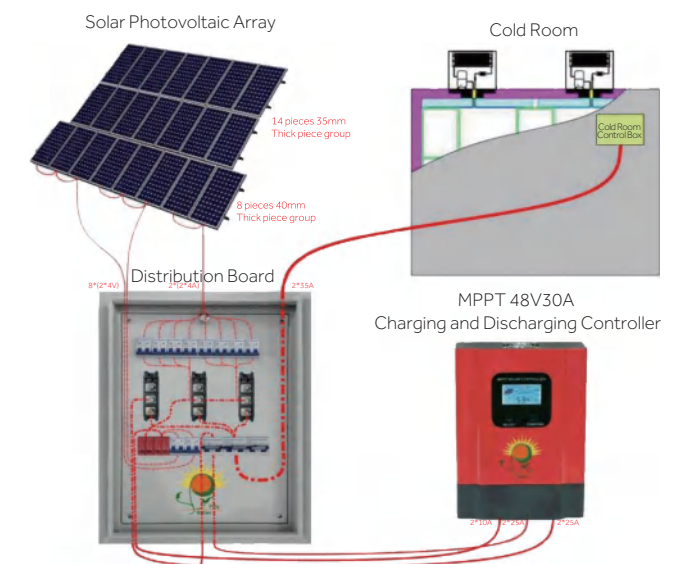



## Vaccine Refrigerated Vehicle

- High chassis, excellent cross-country capacity.
- Euro-2 standard, easy and low-cost maintenance in African area with backup power.
- Complies with WHO/PQS standard requirements.
- Backup power supply.
- Heating system to use in -20°C ambient temperature.

## Vaccine Stock Monitoring Solution

Monitoring the vaccine status of all vaccination sites nationwide, providing Enterprise Resource Planning (ERP) management for decision makers with timely and accurate information of vaccine inventory and temperatures.



### Function:

- Manual entry of vaccine stock.
- Data acquisition of temperature.
- Receives immunization notifications.
- Checks inventory reports.
- Check inventory trend and alarm information.
- Information data and files of vaccines.
- Checking vaccine warehousing plans.
- Submitting information for invalid vaccines.
- Checking historical temperature curve.

- 7-inch touch screen.
- Internal Internet-enabled SIM card.
- Solar power USB, EHC power supply.
- External NTC temperature sensor.

No	Vaccine	Quantity	Doses	Updated	Alert Levels
1	MR	29	does	2019/10/20	Low
2	OPV	89	does	2019/10/20	No alert
3	DTP+HepB+Hib	9	does	2019/10/20	High
4	BCG	6	does	2019/10/20	High
5	HPV	2	does	2019/10/20	High
6	Td	90	does	2019/10/20	Low

## U-COOL Remote Temperature Monitoring Device

### Remote Temperature Recording:

- The external temperature sensor measures the temperature, records and stores the measured temperature values automatically, and transmits them to the cloud platform.

### Application Scenarios:

- It can be used for real-time monitoring of storage and distribution of medicine, vaccine, blood, reagents, biological products, biological sample tissue, food and other items. The application scenarios include refrigerated trucks, incubators, cold rooms, cold packs, refrigerated cabinets, refrigerators, freezers and so on.

Cloud Platform Website <http://ems.haierbiomedical.com>

### U-COOL



- Once powered on, the device immediately uploads the data automatically to the portal. Plug and play - one simple activation - no technical skills needed, easy and user friendly.
- Remote portal management platform, which can track temperature, location, signal strength information and has multiple data analysis reports.
- Powered by mains supply with battery back up (10 days) in the event of power failure
- The device supports sound and visual alarms.
- High precision sensors: -40C +65C (NTC) -200C +150C (PT100)
- High precision, wide range of temperature measurements.
- IP65 protection, waterproof, shockproof and dustproof to fit a variety of complex environments.
- Complies with WHO Standards, WHO prequalified code: E006/060

### Specifications

Model	U-COOL
Temperature Sensor	Internal temperature/humidity sensor: 1; External temperature sensor: 1
Measurement Items	Ambient temperature/humidity, cold chain equipment temperature
Measurement Unit	°C, %RH
External Probe	NTC PT100 (optional)
Temperature Range	NTC: -40°C~+65°C; PT100: -200°C~+150°C
Accuracy	NTC: ±0.5°C within 0°C to +65°C, ±1°C within -40°C to +0°C PT100: ±0.3°C
Resolution Ratio	0.1°C
Storage Capacity	60000 sets
Acquisition Frequency	600s (Adjustable)
Upload Frequency	600s (Adjustable)
Local Alarm	Sound buzzer alarm and light flashing alarm (off by default, openable)
Remote Alarm	Support global SMS, telephone dialing and email alarm (user configurable)
SIM Card	Global roaming card (Standard) / local SIM card (optional)
Communication Net Work Mode	2G/3G/4G
Ambient Temperature	-10°C~+55°C
Power Supply Optional Solar Panel	Built-in rechargeable battery, power adapter DC220V, 50HZ
Standby Time	Support charge and discharge 300 times, single charge standby ≥10 days (Normal signal, acquisition frequency 10min/ time)
IP	IP66
Exterior Dimension	114.5*71.5*22mm
Shell Material	Shell: PA66 plus 30% fiber; Shell sleeve: ABS
Weight	400g
Warranty	3 years

## U-COOL-PRO

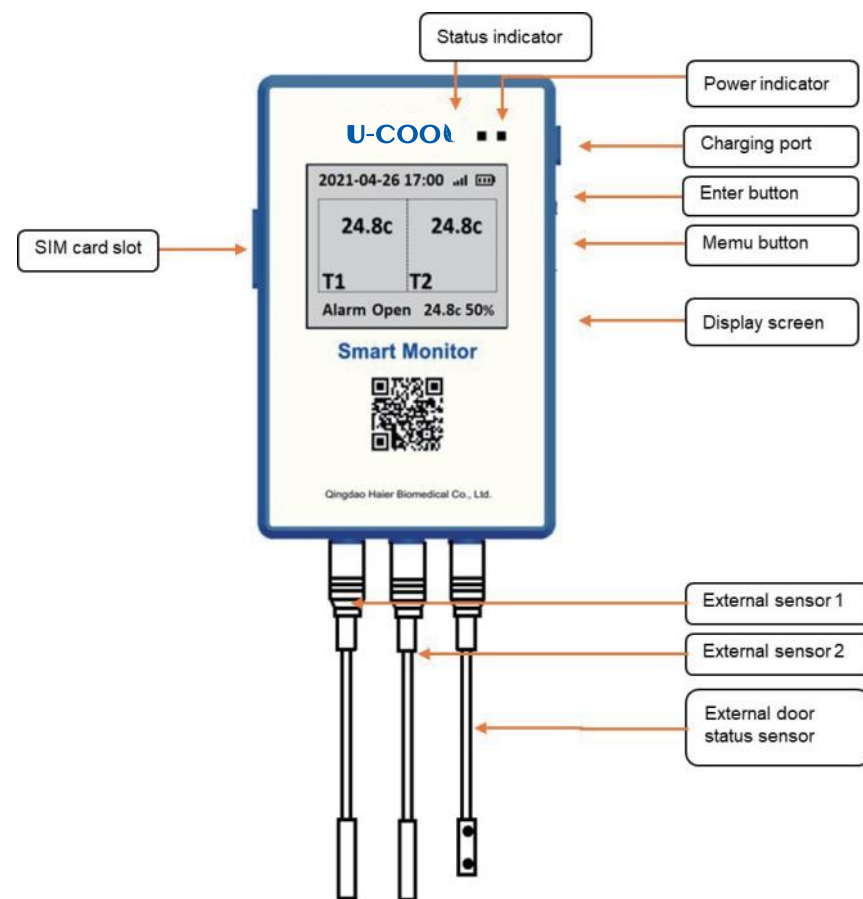

## Product Advantages

- The battery powered do not require a local power supply or network cabling and can be installed
- Users can select a local sound and light alarm via the software, alerting users if the temperature exceeds set thresholds or the device malfunctions
- LBS base station positioning, indoor use can also be positioned
- USB data export (30 days temperature record)
- One charge, more than 10 days of battery life
- 2 pluggable temperature sensors, 1 pluggable door switch sensor
- Supports 4G/3G/2G signal

## Specifications

Model	U-COOL Pro
Temperature Sensor	Internal temperature/humidity sensor: 1; External temperature sensor: 2
Measurement Items	Ambient temperature/humidity, cold chain equipment temperature
Measurement Unit	°C, %RH
External Probe	NTC PT100 (Optional)
Temperature Range	NTC: -40°C~+65°C; PT100: -200°C~+150°C
Accuracy	NTC: ±0.5°C within 0°C to +65°C, ±1°C within -40°C to +0°C PT100: ±0.3°C
Resolution Ratio	0.1°C
Storage Capacity	60000 sets
Acquisition Frequency	600s
Upload Frequency	600s
Local Alarm	Sound buzzer alarm and light flashing alarm (off by default, user configurable)
Remote Alarm	Support global SMS, telephone dialing and email alarm (user configurable)
SIM Card	Global roaming card (Standard) / local SIM card (optional)
Communication Net Work Mode	2G/3G/4G
Ambient Temperature	-10°C~+55°C
Power Supply Optional Solar Panel	Built-in rechargeable battery, power adapter DC220V, 50HZ
Standby Time	Support charge and discharge 300 times, single charge standby ≥10 days (Normal signal, acquisition frequency 10min)
IP	IP64
Exterior Dimension	112mm*75mm*21mm
Shell Material	Shell: PC
Weight	380g
Warranty	3 years

## U-Cool-LoRa

## Introducing Our RF Wireless Monitoring System

The UCool LoRa monitoring system consists of a central gateway and multiple, wireless sensors. The intelligent 4G gateway is connected to the cloud-based monitoring platform, and offers real-time monitoring and alarming of multiple parameters including temperature, humidity & status.





**YB-HC600-01**  
Temperature Data Logger



**YB-HC600-02**  
Door On-off Monitor



**YB-HC600-03**  
Power Outage Monitor



**YB-HZ600-01**  
Smart Gateway

## Product Advantages

### Long communication distance

LoRa spread spectrum modulation is adopted for wireless communication, which works in the sub-1 GHz band. Offering long communication distances, and a strong ability for signals to pass through obstacles/walls, with excellent anti-interference properties, there is no need to run data cabling or power supply cables to each sensor. As they are battery powered, they are separate from your building infrastructure and will continue transmitting in the event of an onsite power failure/network interruption.

### Local audible and visual alarm

When the recorded temperature exceeds the set domain value, or the acquisition node is not working normally, the local audible and visual alarm can be activated through the online configuration tool.

### Micro-USB for local data export

It is equipped with standard a Micro-USB interface to cooperate with PC software for local data export.

### Power supply mode

The sensor is powered by user-changeable batteries, and the gateway by an external power adaptor. When power is lost to the gateway, it switches to its built-in 48hr battery backup.

### Pluggable aviation plug

- 1) The probe is installed inside the equipment, and can be disconnected to allow the transmitter to be removed for further operation (e.g. for battery change or data download);
- 2) When the probe is broken or damaged, it is easy to replace;
- 3) The plug-type is more robust than the 3.5mm audio connector, and offers better electromagnetic protection.

Model	U-COOL-LoRa: Gateway	U-COOL-LoRa: Temperature Data Logger	U-COOL-LoRa: Door On-off Logger	U-COOL-LoRa: Power Outage Logger
Temperature Sensor	/	External sensor: 1	External door status sensor: 1	External power outage sensor: 1
Measurement Items	/	Temperature	Door on-off status	Power
External Probe	/	Digital, PT100 (Optional)	Magnetic reed switch	Mains power relay
Temperature Range	/	Digital: -40°C~+80°C PT100: -199°C~+199°C	/	/
Accuracy	/	0.5°C	/	/
Resolution Ratio	/	0.1°C	/	/
Storage Capacity	60000 sets	60000 sets	60000 sets	60000 sets
Acquisition Frequency	600s (Adjustable)	600s (Adjustable)	600s (Adjustable)	600s (Adjustable)
Upload Frequency	600s (Adjustable)	600s (Adjustable)	600s (Adjustable)	600s (Adjustable)
Local Alarm	Sound buzzer alarm and light flashing alarm	Sound buzzer alarm and light flashing alarm (off by default, openable)		
Remote Alarm	Support global SMS, telephone dialing and email alarm (user configurable)	/	/	/
SIM Card	Global roaming card (Standard)/ local SIM card (optional)	/	/	/
Communication Net Work Mode	4G/LoRa	LoRa	LoRa	LoRa
Ambient Temperature	-10°C~+55°C	-10°C~+55°C	-10°C~+55°C	-10°C~+55°C
Power Supply	Built-in rechargeable battery, power adapter DC220V, 50HZ	Two non-rechargeable batteries, 3.6V	Two non-rechargeable batteries, 3.6V	Two non-rechargeable batteries, 3.6V
Standby Time	Single charge standby ≥48h	3 years (Normal signal, acquisition frequency 10min/ time)	3 years (Normal signal, acquisition frequency 10min/ time)	3 years (Normal signal, acquisition frequency 10min/ time)
IP	IP50	IP65	IP65	IP65
Exterior Dimension	160mm*100mm*33mm	125mm*73mm*23mm	125mm*73mm*23mm	125mm*73mm*23mm
Shell Material	Aluminium +PC panel	ABS	ABS	ABS
Weight	640g	150g	150g	150g
Warranty	3 years	3 years	3 years	3 years

\*Haier Biomedical reserves the right to change products and specifications without prior notice.

## Equipment Management

User can monitor data in real time  
(Ultra-low temperature refrigerator, Liquid nitrogen tank, etc)

Making it easy to collect data from onsite Haier Biomedical equipment, and then transmit recorded data to the cloud-based monitoring platform, the IOT module allows the remote viewing of various parameters which would usually only be available on the unit itself. The platform also facilitates remote alarming, allowing users to be alerted to an excursion even when you are not on site. Suitable for the monitoring of a variety of equipment, including Ultra-Low Temperature freezers and Liquid Nitrogen storage, it is perfect for hospitals, academia, laboratories and more.



## Product Advantages

Easy configuration, plug and play

Uninterrupted and highly reliable connectivity through the 2G/3G/4G network, with data uploaded to the cloud-based monitoring platform.

Easy for Remote Management  
Through remote monitoring and centralized management, you can easily track your devices and enjoy better efficiency for large scale deployment and preventive maintenance.

Purposely Designed for Industrial Scenarios  
EMC level 3, IP30 protection rating, and wide temperature and voltage ranges make it enduring in challenging environments.

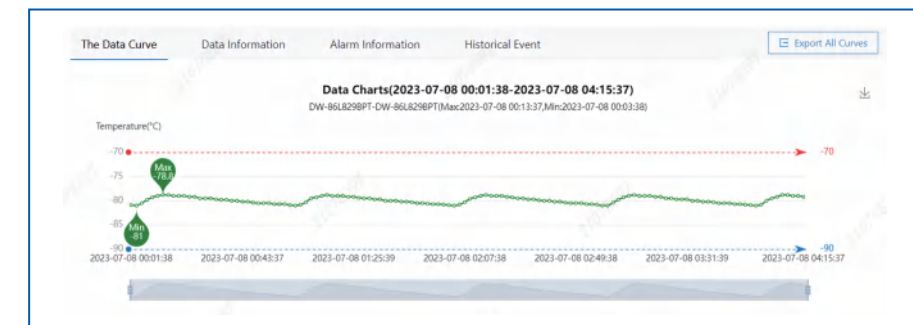
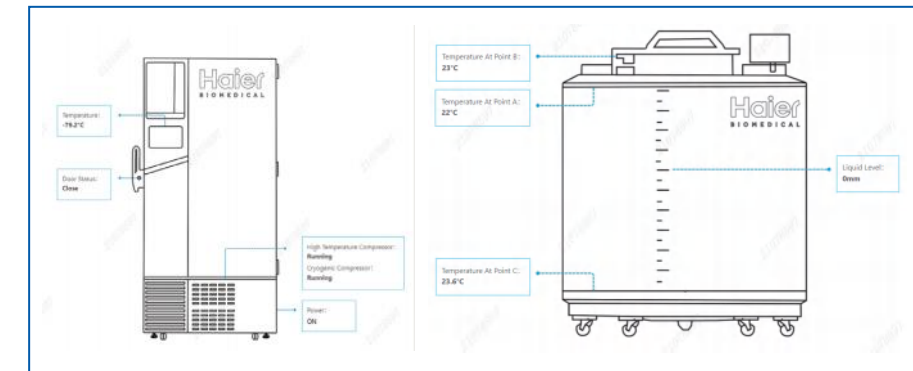
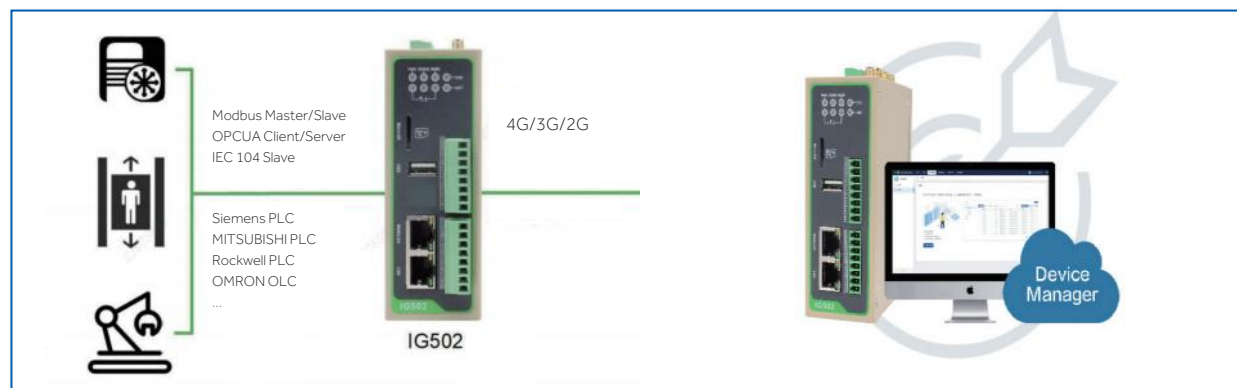

## Map Display

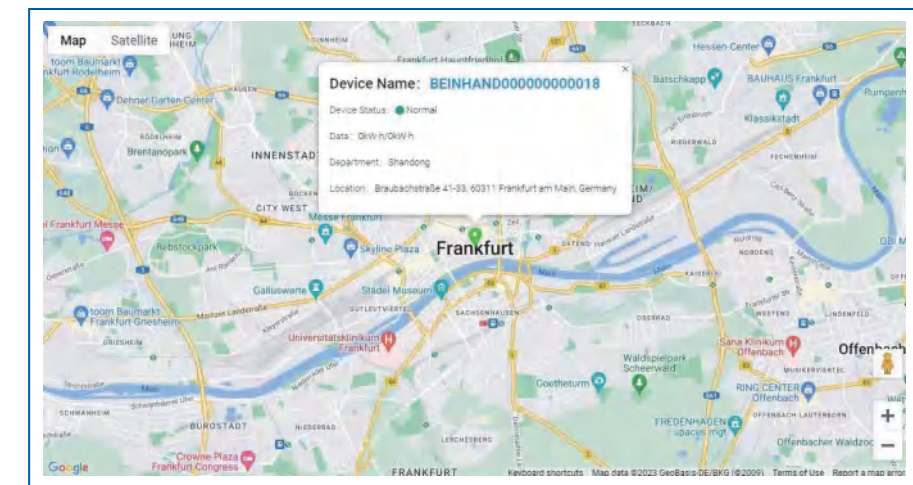

## Hardware Specifications

Model	IG502	
Hardware Platform	CPU	ARM Cortex-A8
	Memory Capacity	512MB
	FLASH	8GB eMMC
Port	Ethernet Port	2*10/100Mbps fast Ethernet port, 1*WAN+1*LAN or 2*LAN
	Serial Port (optional)	RS485*1, RS232*1 or RS485*2
	Wi-Fi (optional)	2.4G (802.11/b/g/n)
	GPS (optional)	GPS, SMAX1
	USB	USB2.0x1
	IO Port (optional)	4*DI, 4*DO
	Reset Key	Pinhole reset button
	TF	Support MicroSD
	Bluetooth (optional)	BLE4.0
Mechanical Features	Installation Methods	Rail, wall hanging, ear hanging
	Cooling Type	Fan-free cooling
	Shell	Metal shell
	IP Grade	IP30
Power Supply	Power Input	DC12-48V, Anti-reverse protection
	Standby Power Loss	200mA@12V
	Peak Power	500mA@12V
	Power Port	CLIPLINE
	Working Power Consumption	250mA@12V
Environment	Working Temperature	-20~70°C
	Environment Humidity	5-95% (Frost-free)
	Storage Temperature	-40~85°C
Indicator Light	LED	PWR, STATUS, WARN, ERR, Signal strength indicator lamps (3), LTE
EMC	Static Electricity	EN61000-4-2, level3
	Radiation Electric Field	EN61000-4-3, level3
	Pulsed Electric Field	EN61000-4-4, level3
	Surge	EN61000-4-5, level3
	Onducted Emission	EN61000-4-6, level3
	PFMF	EN61000-4-8, Horizontal direction/vertical direction 400A/m (>level3)
Physical Characteristics	Oscillation Wave Immunity	EN61000-4-12, level3
	Quakeproof	IEC60068-2-27
	Drop	IEC60068-2-32
Vibration		IEC60068-2-6
	Others	Authentication Certificate CE/UKCA/FCC/PTCRB/UL/C1D2 (Class 1Division 2)/ VerizonWireless/AT&T/IC/RCM/NBTC/ANATEL

\*Haier Biomedical reserves the right to change products and specifications without prior notice.

## Software Specifications

Model	IG502	
Operating System	Operating System	Customized Linux
Network Interconnection	Network Access	APN/VPDN
	Access Authentication	CHAP/PAP/MS-CHAP/MS-CHAPV2
	Network Standard	5G SA/NSA/LTECat4/LTECat1
	LAN Protocol	ARP/Ethernet
	WAN Protocol	Support static IP/DHCP
Network Protocol	IP Application	ICMP/DNS/TCP/UDP/TCPserver/DHCP
	IP Routing	Support static routing
Network Security	Multilevel User	Support multi-level administrative permissions
	Data Security	Support OpenVPN, support IPsecVPN
Reliability	Backup Function	Support dual SIM cards
	Link Online Detection	Heartbeat packet detection is sent, and the disconnection is automatically reconnected.
	Embedded Watchdog	Self-inspection technology of equipment operation, self-repair of equipment operation failure
Open Platform	Open Platform	Support Python development platform
	Access Cloud Platform	Support cloud platforms such as AWS, Azure and Ali
Protocol Type	Protocol Type	Modbus/slave, Modbus/slave, EtherNet/IP, ISOonTCP, OPCUAClient/Server, MitsubishiMC 3C/3E/3COverTCP, MitsubishiCPUPort, FINSUDP, HostLink, PPI, DLT645-2007, IEC104Server and other protocols.
Maintenance Management	Collocation Method	Configuration of Web interface
	Configure Backup	Support the import and export of configuration files
	Upgrade Mode	Support proprietary upgrade mechanism, and upgrade firmware locally or remotely.
	Log Function	Support local system logs and remote logs, and save important logs in case of power failure.
	Remote Administration	Support InHand Device Manager network management cloud platform, InConnet platform and iSCADA cloud platform; HTTPS, Telnet, SSH, etc.

\*Haier Biomedical reserves the right to change products and specifications without prior notice.



## 30-Day Electronic Temperature Logger

283/284

### Haier Biomedical Vaccine Cold Chain Storage Safety Solution

- Continuous, real-time, whole-process traceable monitoring for vaccine safety storage
- WHO approved and sourced by WHO procurement.

### 30-Day Electronic Temperature Logger



HETL-01



WHO Certified  
PQS code:E006/042

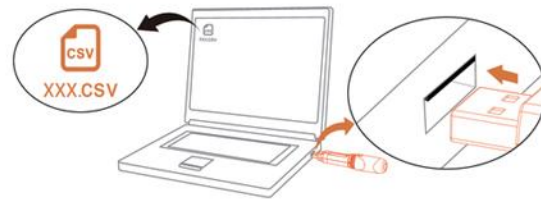

Easy to download data



Accessory: Bracket

### Product Features

- Approved by WHO's PQS, PQS code:E006/042
- Designed specifically for 2-8°C vaccine storage, equipped with high/low temperature visual alarm to meet the WHO standard
- Recording capacity is over 30 days, recording interval is 6 minutes, outdated data will be overwritten by new one automatically, when the recording volume is full
- LCD screen displays temperature
- Integrated sensor device, dust and water resistant to IP65 protection standard, can be placed in Cold Box or vaccine refrigerator to monitor the temperature
- The logger can be plugged into the USB port of any PC to automatically generate a CSV file including temperature data and temperature graph which can be generated by data management software
- Built-in disposable wide temperature range lithium battery (Non-replaceable) with a minimum operating life of two years after a maximum shelf life of one year
- The bracket is included as standard

### Specifications

Model	HETL-01
Temperature Range (°C)	-20--+50
Main Material	ABS (Transparent Shield: PC)
Data Interface	USB Interface
Display Medium	LCD
Resolution (°C)	0.1
Accuracy	±0.5°C for -20°C--+40°C, ±1°C for the others
Recording Volume	8192 Data Points(34 days)
Logging Interval	6 min
Power Source	Non-Replaceable Battery
Size (Length*Diameter mm)	131*24
Service Life	2-3 years

Product appearance and specifications are subject to change without notice



Clean Air  
Solution



# NSF Series Biological Safety Cabinet

287/288

## Scope of Application

Professional air purification equipment suitable for pharmaceuticals, medical and health industries, scientific research laboratories of universities and colleges as well as other related fields.

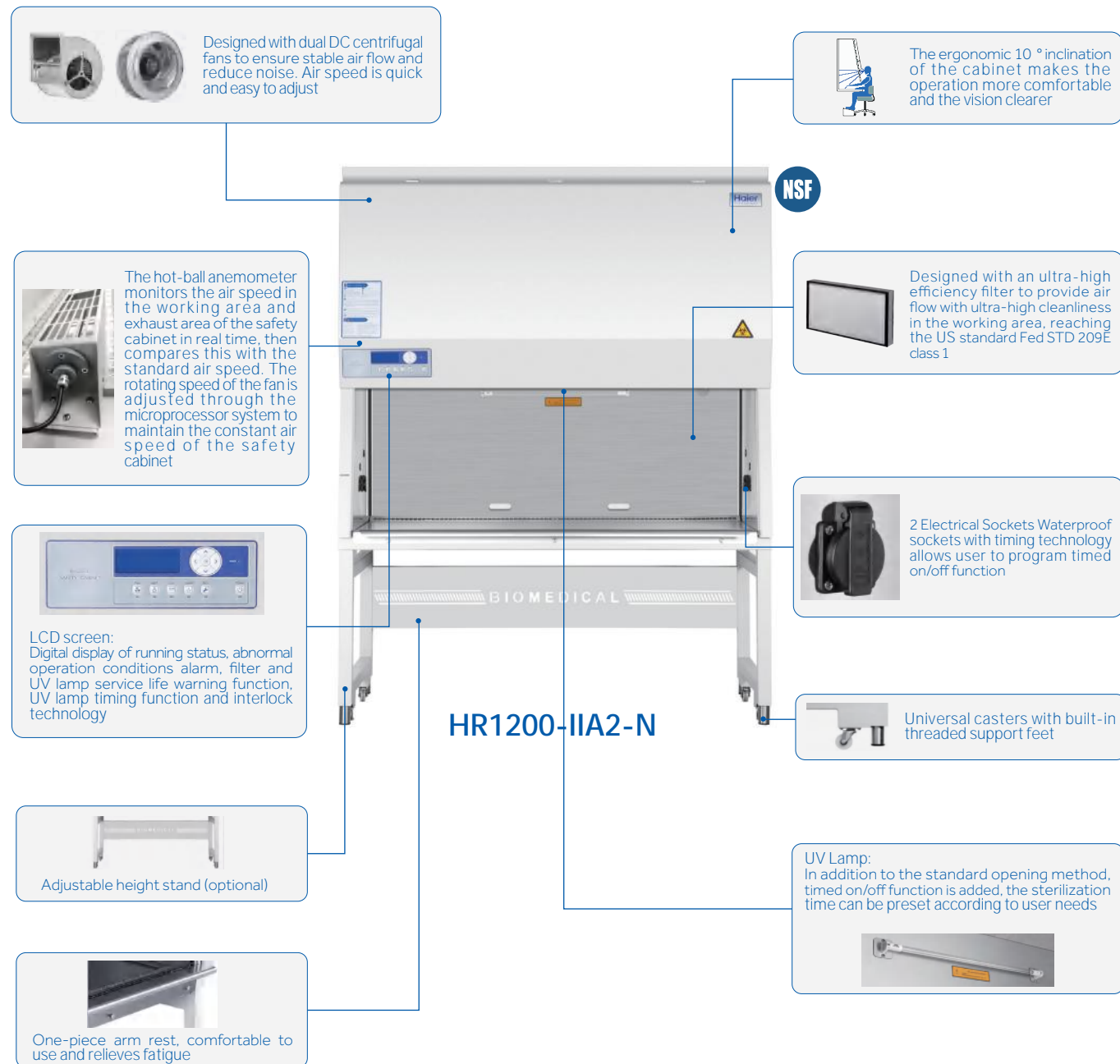

## Product Advantages



### Multiple Voltage Options, Suitable for Many Countries and Regions

Full voltage coverage (100-230V 50/60Hz), suitable for a wide range of countries and regions.



### Microprocessor Control System

- Intuitive and informative interactive digital LCD display.
- The hot-ball anemometer monitors the downflow and inflow air speed of the safety cabinet in real time and compares it with the standard air speed. The rotating speed of the fan is adjusted through the microprocessor system to maintain the constant air speed of the safety cabinet.
- Real-time display of operational information and parameters including downflow air velocity, flow rate, temperature, humidity, positive pressure, negative pressure, fan cumulative running time and filter remaining service life.
- One button UV lamp timer function, allows users to set 0 to 24 hours of automatic on/off time.



### Ultra-low Noise, Uniform Airflow

Designed with Dual DC centrifugal fans, combined with an innovative air distribution system, with lower noise, and more uniform air flow.



### Superior Filter, Multiple Protection

- ULPA is made of moisture-proof and flame-retardant glass fiber filter paper which can intercept 99.9995% solid particles with a diameter of 0.12 μm to ensure high cleanliness of air supply flow and exhaust flow.
- Perfect air distribution design, no turbulence in the working area.
- Sound and light alarm function for abnormal parameters.



### One-piece Welded Cabinet Structure, Leak Proof

Prevention of leakage performance of dangerous factors conforms to NSF specification.



Specifications

Model	HR900-IIA2-N	HR1200-IIA2-N	HR1500-IIA2-N	HR1800-IIA2-N
Working Voltage&Frequency (V/Hz)	100-230/50/60	100-230/50/60	100-230/50/60	100-230/50/60
Power (VA)	1300	1300	1400	1400
Power of Blower (W)	DC 190W 112W	DC 120W 112W	DC 190W 112W	DC 120W 112W
Airflow Circulation	70% Downflow, 30% Exhaust	70% Downflow, 30% Exhaust	70% Downflow, 30% Exhaust	70% Downflow, 30% Exhaust
Main Filter Typical Efficiency	ULPA, U15,99.9995%@0.12um	ULPA, U15,99.9995%@0.12um	ULPA, U15,99.9995%@0.12um	ULPA, U15,99.9995%@0.12um
Exhaust Filter Typical Efficiency	ULPA, U15,99.9995%@0.12um	ULPA, U15,99.9995%@0.12um	ULPA, U15,99.9995%@0.12um	ULPA, U15,99.9995%@0.12um
Filter's Brand	AAF	AAF	AAF	AAF
Downflow Velocity (m/s)	0.35	0.35	0.35	0.35
Inflow Velocity (m/s)	0.53	0.53	0.53	0.53
Lighting Intensity (Lux)	946	1323	/	1292
Sound Level (dB(A))	67	64	/	67
Net/Gross Weight	kg	225/265	275/335	325/365
	lbs	496/584	617/750	716.5/804.7
Internal Dimensions (W*D*H)	mm	930*600*650	1230*600*650	1530*600*650
	in	36.6*23.6*25.6	48.4*23.6*25.6	60.2*23.6*25.6
External Dimensions (W*D*H) (Width without Arm Rest)	mm	1040*850(790)*2160	1340*850(790)*2160	1640*850(790)*2160
	in	40.9*33.5(31.1)*85	52.8*33.5(31.1)*85	64.6*33.5(31.1)*85
Packing Dimensions (W*D*H)	mm	1135*945*1700	1435*945*1700	1735*945*1700
	in	44.7*37.2*66.9	56.5*37.2*66.9	68.3*37.2*66.9
Support Stand (mm)		680mm (standard), 680-900mm adjustable height (optional)	680mm (standard), 680-900mm adjustable height (optional)	680mm (standard), 680-900mm adjustable height (optional)
Sash Opening (mm)		200 (Max 460)	200 (Max 460)	200 (Max 460)
Container Load (20'/40'/40'H)		12/24/24	8/16/16	6/12/12
Alarm		Sound and Flash	Sound and Flash	Sound and Flash
Closing Fan Alarm After Door Opening		Y	Y	Y
Door Ajar		Y	Y	Y
Abnormal Inflow		Y	Y	Y
Abnormal Downflow		Y	Y	Y
Door Open More than Limit		Y	Y	Y
Filter Clogging		Y	Y	Y
Filter Damage		Y	Y	Y
Filter Lifetime Lack		Y	Y	Y
UV Light Lifetime Lack		Y	Y	Y
UV Lamp		Y	Y	Y
Socket		2 sockets (optional GFCI socket)	2 sockets (optional GFCI socket)	2 sockets (optional GFCI socket)
Valve Port		Optional	Optional	Optional
Side Wall Service Taps		Optional gas tap, vaccum tap, compressed air tap and water tap	Optional gas tap, vaccum tap, compressed air tap and water tap	Optional gas tap, vaccum tap, compressed air tap and water tap
Antimicrobial Coating		Optional	Optional	Optional
316SS Work Surface		Optional	Optional	Optional
Work Surface		Single-piece	Single-piece	Single-piece
Touch Screen		Optional	Optional	Optional
Electric Front Sash		/	/	/
Foot Switch		/	/	/
Armrest		Y	Y	Y
Exhaust Duct Connection Kits		Optional	Optional	Optional
Others		UL, NSF	UL, NSF	UL, NSF

\*Haier Biomedical reserves the right to change products and specifications without prior notice

Smart IoT Series Biological Safety Cabinet

Scope of Application

The X series of standard Class II microbiological safety cabinets are suitable for basic cell biology, microbiology, biomedicine, biosafety laboratories and other laboratories.

**HR1200-IIA2-X**

- Advanced ULPA filtration system 10x filtration efficiency compared to the HEPA filter
- Intelligent IoT-based module for monitoring operation conditions with mobile app (Optional)
- Designed with dual DC centrifugal fans, ensure the air flow in the safety cabinet is stable and less noisy. The air speed is easy to adjust
- Cabinet body with 10° inclination to optimize user comfort, reduce glare, and maximize reach into the work area
- 10" touch screen intuitive operation and indicates clear status and performance
- Patented IP-44 rated socket with timer. The sockets can be programmed to supply power at a specified time to meet the users' experiment schedules
- Dual surveillance cameras (Optional)
- Platform-type workbench Ultra-large water collecting basin
- Electronic front sash (Optional)
- Ergonomically-designed armrest helps prevent blocking of the grill to optimise air flow whilst supporting a more comfortable working posture
- Height-adjustable stand
- Foot switch (Optional)
- Universal caster with built-in threaded supporting leg

## Product Advantages



### Microprocessor Control System

- Utilizing intelligent constant air speed design to monitor the downward airflow and the inlet airflow in real-time. The dual airspeed sensors adjust the fan speed through a microcomputer system so as to maintain constant airspeed inside the cabinet
- Intuitive and informative interactive touch screen
- Real-time display of operational information and parameters including downflow air velocity, flow rate, temperature, humidity, positive pressure, negative pressure, fan cumulative running time and filter remaining service life



### Electronic Front Sash (optional)

With push button simplicity the front window automatically opens to the correct aperture mandated by regional regulation to help ensure proper working conditions



### Dual Cameras (optional)

As an option, two surveillance cameras can monitor and record the conditions at each side of the working area. The camera is positioned to avoid any splashback within the working area, minimizing cleaning required



### Intelligent IoT Module (optional)

An IoT module is an option available to enable users to simply manage the biosafety cabinets, any time anywhere, using our app. The system monitors the cabinet in real-time and alerts in the event of any abnormal alarms. Users can view operational parameters, operation performance curves, event and alarm records as well as other useful information



### Ultra-low Noise, Uniform Airflow

Designed with dual DC fans, for up to 50% energy savings vs AC motor, meeting the low-noise, energy-saving and high-reliability requirements



### One-touch UV Lamp Operation

One-button UV lamp timer, learns and retains users' UV lamp usage habits for convenient one-key start-up of the UV lamp timing function



### Foot Switch (optional)

The foot switch will open or close the front sash to allow users to access samples without direct contact with the sash handle



### Easy to Clean

The armrest can be removed and the unique drop-down front sash can be removed in seconds to enable easy cleaning and full access to the cabinet interior work space for thorough cleaning/disinfection



### Interlocking Design to Ensure Maximum Safety and Reliability

UV lamp, front sash, fan and interior light operation are interlocked together to protect against harmful UV rays and to prevent leakage of microorganisms



### PIR Detection

In intelligent mode, the PIR sensor will detect when the operating area has been clear of personnel for more than 15 minutes and automatically switch to LNS green-saving mode to reduce the noise level, save energy and prolong the service life of filter

## Specifications

Model		HR1200-IIA2-X	HR1500-IIA2-X	HR1800-IIA2-X	
General Specification	Working Voltage&Frequency (V/Hz)	220-240 50/60	220-240 50/60	220-240 50/60	
	Power (VA)	1600	1670	1850	
	Power of Blower (W)	DC 120, DC 112	DC 190, DC 112	DC 120, DC 112	
	Airflow Circulation	70% Downflow, 30% Exhaust	70% Downflow, 30% Exhaust	70% Downflow, 30% Exhaust	
	Main Filter Typical Efficiency	ULPA, U15, 99.9995% @ 0.12um	ULPA, U15, 99.9995% @ 0.12um	ULPA, U15, 99.9995% @ 0.12um	
	Exhaust Filter Typical Efficiency	ULPA, U15, 99.9995% @ 0.12um	ULPA, U15, 99.9995% @ 0.12um	ULPA, U15, 99.9995% @ 0.12um	
	Exhaust Filter	Single	Single	Single	
	Filter's Brand	AAF	AAF	AAF	
	Downflow Velocity (m/s)	0.3	0.3	0.3	
	Inflow Velocity (m/s)	0.45	0.45	0.45	
Lighting Intensity (Lux)	1317	1396	1133		
Sound Level (dB(A))	59.3	61	63.5		
Dimensions	Net/Gross Weight	kg	280/340	320/400	380/465
		lbs	617/750	705/882	838/1025
	Internal Dimensions (W*D*H)	mm	1230*600*655	1530*600*655	1830*600*655
		in	48.4*23.6*25.8	60.2*23.6*25.8	72.0*23.6*25.8
	External Dimensions (W*D*H) (Width without Arm Rest)	mm	1336*845 (790)*2120	1636*845 (790)*2120	1936*845 (790)*2120
		in	52.6*33.3 (31.1)*83.5	64.4*33.3 (31.1)*83.5	76.2*33.3 (31.1)*83.5
	Packing Dimensions (W*D*H)	mm	1435*945*1700	1720*945*1700	2038*945*1700
		in	56.5*37.2*66.9	67.7*37.2*66.9	80.2*37.2*66.9
Support Stand (mm)		680-900mm adjustable height (standard)	680-900mm adjustable height (standard)	680-900mm adjustable height (standard)	
Sash Opening (mm)		200 (Max 480)	200 (Max 480)	200 (Max 480)	
Container Load (20'/40'/40'H)		8/16/16	6/12/12	6/12/12	
Alarms Functions	Alarm	Sound and flash	Sound and flash	Sound and flash	
	Closing Fan Alarm After Door Opening	Y	Y	Y	
	Door Ajar	Y	Y	Y	
	Abnormal Inflow	Y	Y	Y	
	Abnormal Downflow	Y	Y	Y	
	Door Open More than Limit	Y	Y	Y	
	Filter Clogging	Y	Y	Y	
	Filter Damage	Y	Y	Y	
	Filter Lifetime Lack	Y	Y	Y	
	UV Light Lifetime Lack	Y	Y	Y	
Accessories	UV Lamp	Y	Y	Y	
	Socket	2 sockets	2 sockets	2 sockets	
	Valve Port	Optional	Optional	Optional	
	Side Wall Service Taps	Optional gas tap, vaccum tap, compressed air tap and water tap	Optional gas tap, vaccum tap, compressed air tap and water tap	Optional gas tap, vaccum tap, compressed air tap and water tap	
	Antimicrobial Coating	Optional	Optional	Optional	
	316SS Work Surface	Optional	Optional	Optional	
	Work Surface	Single-piece	Single-piece	Single-piece	
	Touch Screen	Standard	Standard	Standard	
	Electric Front Sash	Optional	Optional	Optional	
	Foot Switch	Optional	Optional	Optional	
Others	Armrest	Y	Y	Y	
	Exhaust Duct Connection Kits	Optional	Optional	Optional	
	Certification	CE, TUV	CE, TUV	CE, TUV	

\*Haier Biomedical reserves the right to change products and specifications without prior notice

## Biological Safety Cabinet (Single/Double exhaust filter)

293/294

### Scope of Application

Suitable for microbiology, biomedicine, biosafety laboratories and other laboratories. It offers three levels of protection-operator, product and environment

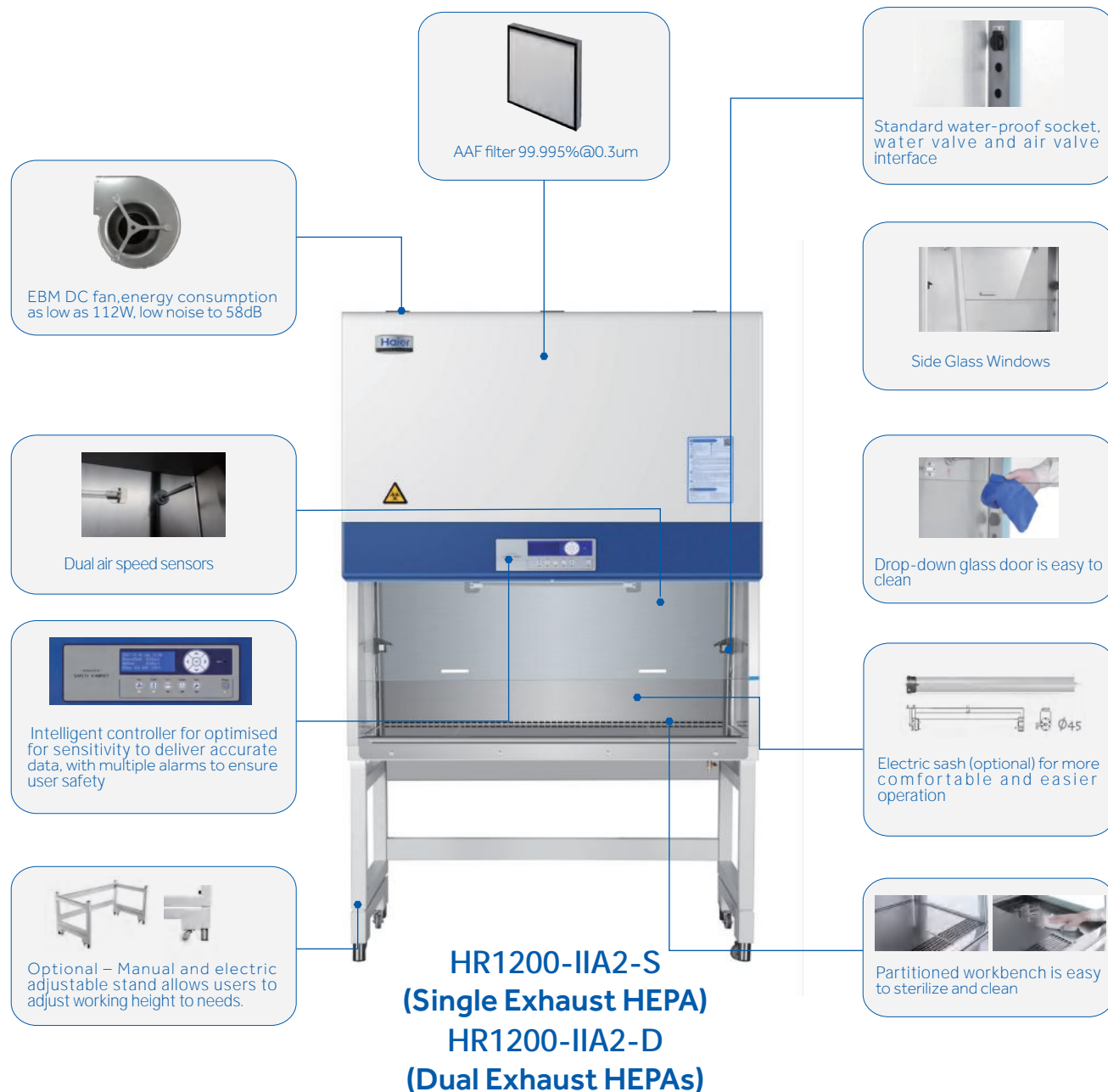

### Product Advantages



#### Ultra-efficient Filtration

High efficiency moisture proof and flame-retarded filter achieving a retention efficiency of 99.9995% for 0.12 micron solid particle system



#### Intelligent Constant Air Velocity System

Designed with intelligent constant air speed technology, which can ensure that the working area could have its downflow and inflow velocities in line with the standard requirements



#### Side Glass Windows

Tempered glass side walls increase visibility and prevents the operator from experiencing a "boxed-in" feeling



#### Multiple Alarm Functions

Audible and visual alarm functions: filter and UV end-of-life alerts, fan turned-off after door opening alert and door open alarm



#### Ergonomic Design

- A comfortable platform-type armrest can reduce hand and arm fatigue
- 10-degree angle inclination design, in accordance with ergonomic principles for more comfortable operation
- With height adjustable stand, users can adjust the height of the work bench to requirements



#### Easy to Clean

The armrest can be removed and the unique drop-down front sash can be removed in seconds to enable easy cleaning and full access to the cabinet interior work space for thorough cleaning/disinfection



#### Patented IP-44 Rated Socket with Timer

The sockets can be programmed to supply power at a specified time to meet the users' experiment schedules



#### Lower Noise and Airflow Uniformity

DC&EC fans operate with lower noise and deliver excellent air flow uniformity



#### PIR Detection

In intelligent mode, the PIR sensor will detect when the operating area has been clear of personnel for more than 15 minutes and automatically switch to LNS green-saving mode to reduce the noise level, save energy and prolong the service life of filter



#### UV Lamp

Patented one-button UV lamp technology allows users to automatically activate or deactivate based on usage habits or at specific sterilization intervals to minimise waiting time



## Biological Safety Cabinet (Single/Double exhaust filter)

## Biological Safety Cabinet

295/296

## Specifications

Model	HR900-IIA2-S	HR1200-IIA2-S	HR900-IIA2-D	HR1200-IIA2-D	
Working Voltage&Frequency (V/Hz)	220-240 50/60	220-240 50/60	220-240 50/60	220-240 50/60	
Power (VA)	1500	1600	1500	1600	
Power of Blower (W)	DC 120W/EC170W	DC 120, DC 112	DC 120W/EC170W	DC 190, DC 170	
Airflow Circulation	70% Downflow, 30% Exhaust	70% Downflow, 30% Exhaust	70% Downflow, 30% Exhaust	70% Downflow, 30% Exhaust	
Main Filter Typical Efficiency	ULPA, U15, 99.9995% @ 0.12um	HEPA, H14, 99.995% @ 0.3um	ULPA, U15, 99.9995% @ 0.12um	ULPA, U15, 99.9995% @ 0.12um	
Exhaust Filter Typical Efficiency	ULPA, U15, 99.9995% @ 0.12um	HEPA, H14, 99.995% @ 0.3um	ULPA*2, U15, 99.9995% @ 0.12um	HEPA*2, H14, 99.995% @ 0.3um	
Exhaust Filter	Single	Single	Double	Double	
Filter's Brand	AAF	AAF	AAF	AAF	
Downflow Velocity (m/s)	0.3	0.3	0.3	0.3	
Inflow Velocity (m/s)	0.45	0.45	0.45	0.45	
Lighting Intensity (Lux)	≥1300	≥1000	≥1300	≥1000	
Sound Level (dB(A))	57.1	60	59.7	60	
Net/Gross Weight	kg	290/320	320/339	290/320	320/339
	lbs	639/705	705.5/747.4	639/705	705.5/747.4
Internal Dimensions (W*D*H)	mm	936*620*635	1310*620*635	936*620*635	1310*620*635
	in	36.9*24.4*25	51.6*24.4*25	36.9*24.4*25	51.6*24.4*25
External Dimensions (W*D*H) (Width without Arm Rest)	mm	1002*856(796)*1485	1380*856(796)*2164	1002*856(796)*1485	1380*856(796)*1485
	in	39.5*33.7(31.3)*58.5	54.3*33.7(31.3)*85.2	39.5*33.7(31.3)*58.5	54.3*33.7(31.3)*58.5
Packing Dimensions (W*D*H)	mm	1185*925*1720	1475*935*1720	1105*932*1730	1475*935*1720
	in	46.7*36.4*67.7	58.1*36.8*67.7	43.5*36.7*68.1	58.1*36.8*67.7
Support Stand (mm)	No. 680-900mm adjustable height (optional)	680-900mm adjustable height (standard)	No. 680-900mm adjustable height (optional)	No. 680-900mm adjustable height (optional)	
Sash Opening (mm)	200 (Max 490)	200 (Max 490)	200 (Max 490)	200 (Max 490)	
Container Load (20'/40'/40'H)	11/21/21	8/16/16	11/21/21	8/16/16	
Alarm	Sound and Flash	Sound and Flash	Sound and Flash	Sound and Flash	
Closing Fan Alarm After Door Opening	Y	Y	Y	Y	
Door Ajar Alarm	Y	Y	Y	Y	
Abnormal Inflow Alarm	Y	Y	Y	Y	
Abnormal Downflow Alarm	Y	Y	Y	Y	
Door Open More than Limit Alarm	Y	Y	Y	Y	
Filter Clogging Alarm	Y	Y	Y	Y	
Filter Damage Alarm	Y	Y	Y	Y	
Filter Lifetime Lack Alarm	Y	Y	Y	Y	
UV Light Lifetime Lack Alarm	Y	Y	Y	Y	
UV Lamp	Y	Y	Y	Y	
Socket	2 sockets	2 sockets	2 sockets	2 sockets	
Valve Port	Optional	Optional	Optional	Optional	
Side Wall Service Taps	Optional gas tap, vacuum tap, compressed air tap and water tap	Optional gas tap, vacuum tap, compressed air tap and water tap	Optional gas tap, vacuum tap, compressed air tap and water tap	Optional gas tap, vacuum tap, compressed air tap and water tap	
Antimicrobial Coating	Optional	Optional	Optional	Optional	
316SS Work Surface	Optional	Optional	Optional	Optional	
Work Surface	Three-pieces	Four-pieces	Three-pieces	Three-pieces	
Touch Screen	/	/	/	/	
Electric Front Sash	Optional	Optional	Optional	Optional	
Foot Switch	Optional	Optional	Optional	Optional	
Armrest	Y	Y	Y	Y	
Exhaust Duct Connection Kits	Optional	Optional	Optional	Optional	
Others	Certification	CE, UKCA	CE, UKCA, TUV	CE, UKCA	CE, UKCA, TUV

\*Haier Biomedical reserves the right to change products and specifications without prior notice

## Scope of Application

This Class II microbiological safety cabinet is designed to protect the operator, laboratory environment and samples from being exposed to the infective aerosol produced from samples with bacteria strains, diagnostic materials, and other infective substances. It provides the operator with comfortable and safer working conditions. It is widely used in medical health, disease prevention, food safety, biological pharmacy and environment monitoring.



# Biological Safety Cabinet

# Mini Biological Safety Cabinet

297/298

## Product Advantages

**V-shaped Air Inlet**  
The V-shaped air inlet can prevent the samples or arms of operator from blocking the air flow. The work surface can be easily lifted using the handles for cleaning purposes

**One-touch UV Lamp Operation**  
UV lamp records and remembers users' setting and habits and can be preset with a startup delay with one-key operation for ease and convenience

**Energy Conservation**  
**PIR detection**  
In intelligent mode, the PIR sensor will detect when the operating area has been clear of personnel for more than 15 minutes and automatically switch to LNS green-saving mode to reduce the noise level, save energy and prolong the service life of filter

**Ergonomic**

- 10° inclination design of cabinet body**  
The front operation interface has an ergonomic design of 10° inclination for ensuring more comfortable operation
- Stainless steel armrest**  
A comfortable platform-type armrest can reduce hand and arm fatigue

**Easy to Clean**  
The armrest can be removed and the unique drop-down front sash can be removed in seconds to enable easy cleaning and full access to the cabinet interior work space for thorough cleaning/disinfection

**Intelligent**  
**Constant airflow velocity**  
The hot-bulb airflow velocity transducer performs real-time monitoring of the air velocity of the working area, compares it with the standard air velocity, and keeps a constant air velocity in the cabinet by regulating the fan speed with a microcomputer system

**IP 44 Rated Power Sockets with Timer**  
The sockets can be programmed to supply power at a specified time to meet the users' demands for timing of experiments

**Safe**

- Abnormal operation condition alarm**  
Audible and visual alarms in form of voice or text will be present when air turbulence level exceeds 20% and door height (high or low) or work area temperature exceeds limits
- Patented technology: filter end-of-life reminder**  
Pressure transducer monitors the resistance variation of filter to determine the remaining life of filter and will remind the user by warning when the remaining life is below 10%
- Patented technology: UV lamp end-of-life reminder**  
The microcomputer will add up the service time of UV lamp, and will remind by warning the user to replace the UV lamp when its remaining life is less than 10%

**Offers a Broad Range of Sizes to Fit any Available Laboratory Space**

## Scope of Application

Small size microbiological safety cabinet for single person operations and small working spaces, suitable for testing stations within warehouse, airports and mobile laboratories.

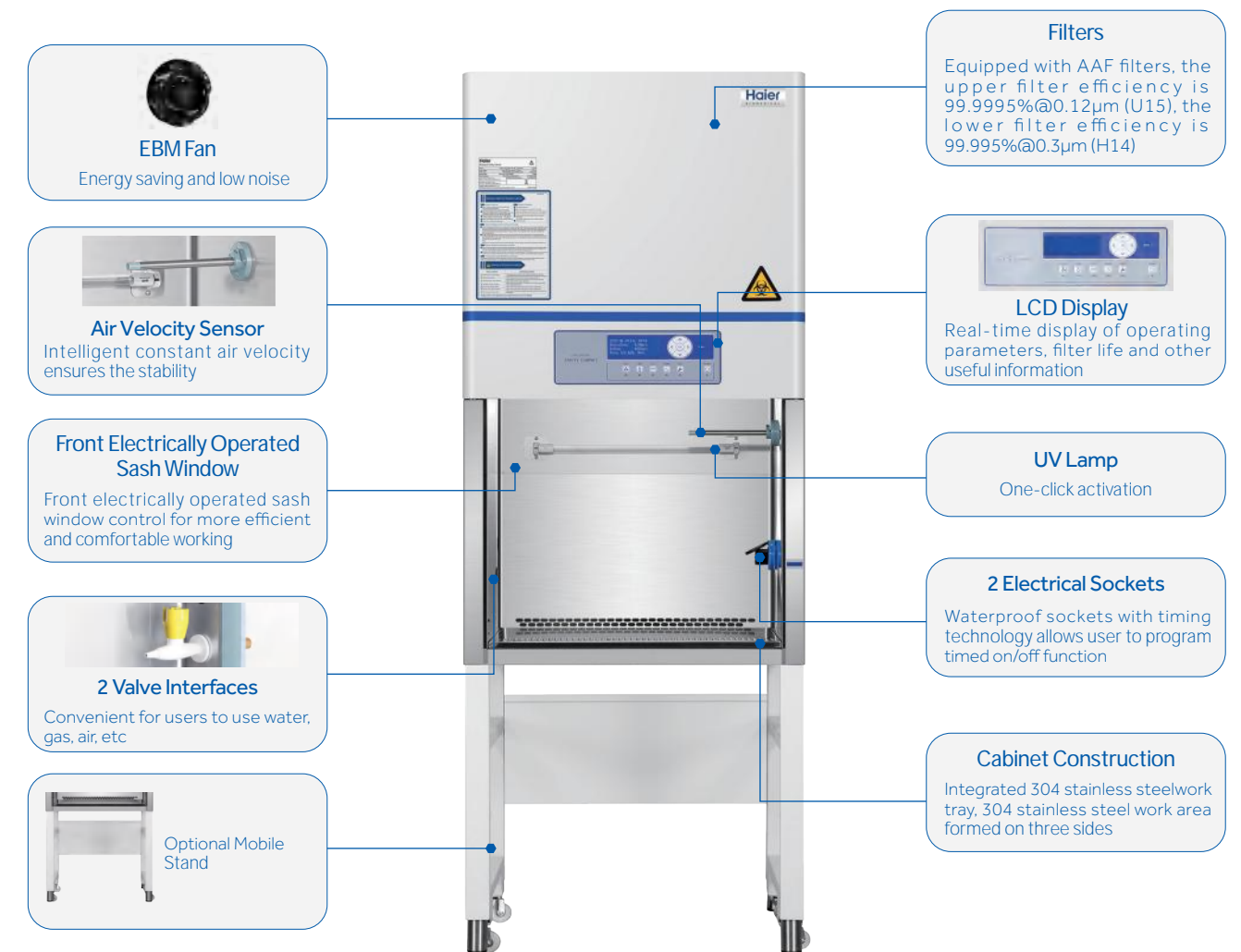

HR700-IIA2

## Mini Biological Safety Cabinet

299/300

## Product Advantages



## Safe and Reliable

Adopts AAF filters, class 1 cleanliness to provide maximum protection for people, environment and samples



## LCD Display

LCD screen displays various parameters and service life of accessories in real time, and the operational condition of the equipment is clear at a glance



## One-click Operation

UV lamp one-click reservation allows users to set 0 min to 24 hours of automatic on/off time and sterilization interval, reducing the waiting time



## Two Waterproof Sockets

Sockets include timing technology to allow users to program socket on/off times



## Interlocking Function

The product features an interlocking function between UV disinfection, fluorescent lamp, front sash and fan



## Alarms

Audible and visual alarm functions: hardware failure alarm, operation parameter overrun alarm, filter and UV lamp life warning



## Uniform Airflow

The EBM fan, combined with Haier Biomedical's professional air distribution design, provides lower noise operation and a uniform air flow



## Safety Certified

Complies with EN12469

## Specifications

Model		HR700-IIA2	HR900-IIA2	HR1200-IIA2	HR1500-IIA2	
General Specification	Working Voltage&Frequency (V/Hz)	220-240 50	220-240 50	220-240 50	220-240 50	
	Power (VA)	1200	1500	1500	1900	
	Power of Blower (W)	210W	AC L=330, M=465, H=735	AC L=330, M=465, H=735	AC 650	
	Airflow Circulation	70% Downflow, 30% Exhaust	70% Downflow, 30% Exhaust	70% Downflow, 30% Exhaust	70% Downflow, 30% Exhaust	
	Main Filter Typical Efficiency	HEPA, H14, 99.995% @ 0.3um	ULPA, U15, 99.9995% @ 0.12um	ULPA, U15, 99.9995% @ 0.12um	ULPA, U15, 99.9995% @ 0.12um	
	Exhaust Filter Typical Efficiency	ULPA, U15, 99.9995% @ 0.12um	ULPA, U15, 99.9995% @ 0.12um	HEPA, H14, 99.995% @ 0.3um	HEPA, H14, 99.995% @ 0.3um	
	Exhaust Filter	Single	Single	Single	Single	
	Filter's Brand	AAF	AAF	AAF	AAF	
	Downflow Velocity (m/s)	0.30	0.33	0.34	0.31	
	Inflow Velocity (m/s)	0.53	0.55	0.55	0.55	
	Lighting Intensity (Lux)	≥780	≥900	≥900	≥900	
	Sound Level (dB(A))	65	60	60	62	
	Dimensions	Net/Gross Weight	kg	100/130	290/310	320/339
lbs			220.4/286.52	639.3/683.4	705.5/747.4	771.6/866.4
Internal Dimensions (W*D*H)		mm	600*550*540	920*620*650	1220*620*650	1520*620*650
		in	23.62*21.65*21.26	36.2*24.4*25.6	48.0*24.4*25.6	59.9*24.4*25.6
External Dimensions (W*D*H) (Width without Arm Rest)		mm	700*720*1200	1080*845(790)*2160	1380*845(790)*2160	1680*845(790)*2160
		in	27.56*28.35*47.24	42.5*33.3(31.1)*85.0	54.3*33.3(31.1)*85.0	66.1*33.5(31.1)*85.0
Packing Dimensions (W*D*H)		mm	800*810*1385 (withoutstand) 825*820*1495 (withstand)	1185*925*1720	1475*935*1720	1785*932*1720
		in	31.5*31.9*54.5 32.5*32.3*58.9	46.7*36.4*67.7	58.1*36.8*67.7	70.3*36.7*67.7
Support Stand (mm)			No.700mm (optional)	680-900mm adjustable height (standard)	680-900mm adjustable height (standard)	680-900mm adjustable height (standard)
Sash Opening (mm)			200 (Max)	200 (Max 490)	200 (Max 490)	200 (Max 490)
Container Load (20'/40'/40'H)		14/28/28	11/21/21	8/16/16	6/12/12	
Alarms Functions	Alarm	Sound and Flash	Sound and Flash	Sound and Flash	Sound and Flash	
	Closing Fan Alarm After Door Opening	Y	Y	Y	Y	
	Door Ajar Alarm	Y	Y	Y	Y	
	Abnormal Inflow Alarm	Y	Y	Y	Y	
	Abnormal Downflow Alarm	Y	Y	Y	Y	
	Door Open More than Limit Alarm	Y	Y	Y	Y	
	Filter Clogging Alarm	Y	Y	Y	Y	
	Filter Damage Alarm	Y	Y	Y	Y	
	Filter Lifetime Lack Alarm	Y	Y	Y	Y	
	UV Light Lifetime Lack Alarm	Y	Y	Y	Y	
Accessories	UV Lamp	Y	Y	Y	Y	
	Socket	2 sockets	2 sockets	2 sockets	2 sockets	
	Valve Port	Optional	Standard with 2 valve port	Standard with 2 valve port	Standard with 2 valve port	
	Side Wall Service Taps	Optional gas tap, vaccum tap, compressed air tap and water tap	Standard gas tap and vaccum tap, optional compressed air tap and water tap	Standard gas tap and vaccum tap, optional compressed air tap and water tap	Standard gas tap and vaccum tap, optional compressed air tap and water tap	
	Antimicrobial Coating	Optional	Optional	Optional	Optional	
	316SS Work Surface	Optional	Optional	Optional	Optional	
	Work Surface	Single-piece	Single-piece	Single-piece	Single-piece	
	Touch Screen	/	/	/	/	
	Electric Front Sash	Standard	Optional	Optional	Optional	
	Foot Switch	Optional	Optional	Optional	Optional	
Others	Armrest	/	Y	Y	Y	
	Exhaust Duct Connection Kits	/	Optional	Optional	Optional	
	Certification	CE, TUV	CE, UKCA, TUV	CE, UKCA, TUV	CE, UKCA, TUV	

\*Haier Biomedical reserves the right to change products and specifications without prior notice





## Classic Series Biological Safety Cabinet (Type A2)

301/302

### Scope of Application

Professional partial air purification equipment, it is suitable for cell biology, microbiology, biomedicine, biosafety and other related laboratories.



HR30-IIA2

### Product Advantages

- Patented air flow blocking technology is designed at the upper edge and both edges of front window to eliminate the exposure of microorganisms
- Real-time display of key parameters: down-flow velocity, inflow velocity, airflow volume, static pressure, negative pressure, accumulative running time off an accumulative running time of UV lamp, and remaining life of filter
- The internal walls on three sides of operation area is constructed by a single plate, and the 12mm arc angle corner for optimal cleaning
- The volume of liquid tank is over 4L, designed with outlet valve for convenient cleaning and maintenance
- Quality 304 stainless steel work surface without screws, no accumulation of contaminant
- Safe**
  - Abnormal operation condition alarm**  
Audible and visual alarms in form of voice or text will be present when air turbulence level exceeds 20% and door height (high or low)
  - Filter end-of-life reminder**  
Pressure transducer monitors the resistance variation of filter to determine the remaining life of filter and reminds the user by warning when the remaining life is below 10%
  - UV lamp end-of-life reminder**  
The microcomputer records service times of the UV lamp and will alert the user to replace the UV lamp when its remaining life is less than 10%
  - Interlocking feature to ensure high safety and reliability**  
Patented technology: UV lamp interlocking control UV lamp, sash, fan and interior light operation are interlocked together to protect against harmful UV rays and to prevent leakage of microorganisms
- Audible and visual alarms for abnormal parameters
- Digital LCD screen
- Dismountable air in-flow plate, easy to clean and sterilize
- UV lamp one-click reservation allows users to set 0 min to 24 hours of automatic on/off time and sterilization interval, reducing the waiting time
- Professional**

**Digital display of operating parameters**

Real-time digital display of down flow, inflow, exhaust volume, filter remaining life, UV lamp remaining life, negative pressure and positive pressure

## Classic Series Biological Safety Cabinet (Type A2)

## Classic Series Biological Safety Cabinet (Type B2)

303/304

## Specifications





Model		HR30-IIA2	HR40-IIA2		
General Specification	Working Voltage&Frequency (V/Hz)	220-240 50/60	115/60	220-240 50/60	
	Power (VA)	1300	1300	1300	
	Power of Blower (W)	AC 540/625	AC 540/625	AC 540/625	
	Airflow Circulation	70% Downflow, 30% Exhaust	70% Downflow, 30% Exhaust	70% Downflow, 30% Exhaust	
	Main Filter Typical Efficiency	ULPA, U15.99.9995%@0.12um	ULPA, U15.99.9995%@0.12um	ULPA, U15.99.9995%@0.12um	
	Exhaust Filter Typical Efficiency	HEPA, H14.99.995%@0.3um	HEPA, H14.99.995%@0.3um	HEPA, H14.99.995%@0.3um	
	Exhaust Filter	Single	Single	Single	
	Filter's Brand	AirePlus	AAF	AAF	
	Downflow Velocity (m/s)	0.3	0.28	0.3	
	Inflow Velocity (m/s)	0.53	0.55	0.53	
	Lighting Intensity (Lux)	≥1100	≥1200	≥1200	
	Sound Level (dB(A))	61	64	64	
	Bench or Stand Only	Stand only	Stand only	Stand only	
Dimensions	Net/Gross Weight	kg	220/248	258/305	258/305
		lbs	485/546.7	568.8/672.4	568.8/672.4
	Internal Dimensions (W*D*H)	mm	900*610*680	1167*610*680	1167*610*680
		in	35.4*24.0*26.8	45.9*24.0*26.8	45.9*24.0*26.8
	External Dimensions (W*D*H)	mm	1100*820*2200	1360*820*2200	1360*820*2200
		in	43.3*32.3*86.6	53.5*32.3*86.6	53.5*32.3*86.6
	Packing Dimensions (W*D*H)	mm	1185*945*1750	1445*945*1720	1445*945*1720
		in	46.7*37.2*68.9	56.9*37.2*67.7	56.9*37.2*67.7
Support Stand (mm)		680mm (standard), 680-900mm adjustable height (optional)	680mm (standard), 680-900mm adjustable height (optional)	680mm (standard), 680-900mm adjustable height (optional)	
Sash Opening (mm)		190 (Max 490)	190 (Max 490)	190 (Max 490)	
Container Load (20'/40'/40'H)		10/20/20	8/16/16	8/16/16	
Alarms Functions	Alarm	Sound and Flash	Sound and Flash	Sound and Flash	
	Closing Fan Alarm After Door Opening	Y	Y	Y	
	Door Ajar	Y	Y	Y	
	Abnormal Inflow	Y	Y	Y	
	Abnormal Downflow	Y	Y	Y	
	Door Open More than Limit	Y	Y	Y	
	Filter Clogging	Y	Y	Y	
	Filter Damage	Y	Y	Y	
	Filter Lifetime Lack	Y	Y	Y	
	UV Light Lifetime Lack	Y	Y	Y	
Accessories	UV Lamp	Y	Y	Y	
	Socket	1 Socket	1 Socket	1 Socket	
	Valve Port	Standard with 2 Valve Port	Standard with 2 Valve Port	Standard with 2 Valve Port	
	Side Wall Service Taps	Standard gas tap and vacuum Tap; optional compressed air tap and water tap	Standard gas tap and vacuum Tap; optional compressed air tap and water tap	Standard gas tap and vacuum Tap; optional compressed air tap and water tap	
	Antimicrobial Coating	Optional	Optional	Optional	
	316SS Work Surface	Optional	Optional	Optional	
	Work Surface	Single-piece	Single-piece	Single-piece	
	Touch Screen	/	/	/	
	Electric Front Sash	/	/	/	
	Foot Switch	/	/	/	
Others	Armrest	Y	Y	Y	
	Exhaust Duct Connection Kits	Optional	Optional	Optional	
	Certification	CE, TUV	/	CE, TUV	

\*Haier Biomedical reserves the right to change products and specifications without prior notice

## Scope of Application

Professional partial air purification equipment, it is suitable for cell biology, microbiology, biomedicine, biosafety and other related laboratories.

## Product Advantages

-  100% exterior exhaust
-  4m corrosion-resistant corrugated hose (standard)
-  Haier Biomedical exterior exhaust fan (optional)
-  Interlocking between safety cabinet and exterior exhauster, enables remote control of exterior exhauster parameters with safety cabinet



HR40-IIB2

## Classic Series Biological Safety Cabinet (Type B2)

## Animal Containment Workstation

305/306

## Specifications

Model		HR40-IIB2	
General Specification	Working Voltage&Frequency (V/Hz)	220-240 50/60	
	Power (VA)	1700	
	Power of Blower (W)	AC 115	
	Airflow Circulation	100% Exhaust	
	Main Filter Typical Efficiency	ULPA, U15,99.9995%@0.12um	
	Exhaust Filter Typical Efficiency	HEPA, H14,99.995%@0.3um	
	Exhaust Filter	Single	
	Filter's Brand	AAF	
	Downflow Velocity (m/s)	0.28	
	Inflow Velocity (m/s)	0.55	
	Lighting Intensity (Lux)	≥1200	
	Sound Level (dB(A))	64	
	Bench or Stand Only	Stand only	
Dimensions	Net/Gross Weight	kg	252/308
		lbs	555.6/679.0
	Internal Dimensions (W*D*H)	mm	1167*610*680
		in	45.9*24.0*26.8
	External Dimensions (W*D*H)	mm	1360*820*2330
		in	53.5*32.3*91.7
	Packing Dimensions (W*D*H)	mm	1445*945*1930
		in	56.9*37.2*76.0
Support Stand (mm)	680mm (standard), 680-900mm adjustable height (optional)		
Sash Opening (mm)	190 (Max 490)		
Container Load (20'/40'/40'H)	8/16/16		
Alarms Functions	Alarm	Sound and Flash	
	Closing Fan Alarm After Door Opening	Y	
	Door Ajar	Y	
	Abnormal Inflow	Y	
	Abnormal Downflow	Y	
	Door Open More than Limit	Y	
	Filter Clogging	Y	
	Filter Damage	Y	
	Filter Lifetime Lack	Y	
	UV Light Lifetime Lack	Y	
Accessories	UV Lamp	Y	
	Socket	1 Socket	
	Valve Port	Standard with 2 Valve Port	
	Side Wall Service Taps	Standard gas tap and vaccum tap; optional compressed air tap and water tap	
	Antimicrobial Coating	Optional	
	316SS Work Surface	Optional	
	Work Surface	Single-piece	
	Touch Screen	/	
	Electric Front Sash	/	
	Foot Switch	/	
Others	Armrest	Y	
	Exhaust Duct Connection Kits	/	
	Certification	CE, TUV	

\*Haier Biomedical reserves the right to change products and specifications without prior notice

## Scope of Application

Applicable for laboratory animal operations (surgery, weighing, etc.) in experimental animal centers of scientific research institutions, hospitals, colleges and universities, or experimental animal research and development projects and breeding institutions.



HR1500-IIA2-DW



## Animal Containment Workstation

### Product Advantages



#### Low Maintenance Costs

Experimental animal hair and debris are captured to eliminate the impact of hair debris and other debris on the service life of the fans and filters which ensures the cabinet is more durable



#### The Dual System Ensures Maximum Safety

Each independent-controlled down flow and inlet airflow system is designed with dual fans, which ensures the stable airflow in the cabinet even if the pre-filter is 50% blocked. In the case of either damage to either fan, the air supply and exhaust system ensure safe air and protection



#### Sectioned Pre-filter

The interior of the sectioned pre-filter is easy to clean, and the pre-filter with a rear-mounted work surface is designed in sections, meaning the filter is easy to disassemble and sterilized as needed



#### Stable Laminar Flow Offers Safety

The intelligent constant air speed design means that if abnormal air velocity is detected the fan adjust automatically to ensure the air speed stay within normal range

### Product Features



#### Safety Interlock

Ultraviolet lamp, sash window, fans, and lamps are interlocked to eliminate hidden dangers of ultraviolet and microorganism leakage



#### Real-time Status Display

The digital screen displays in real time the flow rate of downflow and inflow airflow, the volume of discharged air, the temperature and humidity of the working area, the remaining service life of the filter, the UV lamp, the pressure in the negative pressure area, and positive pressure area. Users are alerted if abnormal operation is detected



#### Traceable

The work area in the cabinet is monitored by camera and the images are stored for future reference (optional)



#### Electric Foot Switch

When it is inconvenient to open the safety cabinet door with both hands, the electric front sash can be opened by foot switch (optional)

### Specifications

Model	HR1500-IIA2-DW
Power (W)	1400
Downflow Velocity (m/s)	0.3
Inflow Velocity (m/s)	0.53
Lighting Intensity (Lux)	≥1100
Net/Gross Weight (kg)	350/400
Interior Dimensions (W*D*H)(mm)	1530*600*653
Exterior Dimensions (W*D*H)(mm)	1636*790*2170
Packing Dimensions (W*D*H)(mm)	1700*925*1715
Container Load (20'/40'/40'H)	6/12/12

\*Haier Biomedical reserves the right to change products and specifications without prior notice

## Laminar Flow Cabinet

307/308

### Scope of Application

A professional localized air purification equipment suitable for pharmaceuticals, medical and health, scientific research laboratories of universities and colleges, photoelectric/microelectronics manufacturing and other fields



### Product Advantages



Moisture-proof and flame-retardant glass fiber high efficiency particulate air filters (HEPA), ensure a filtration efficiency of 99.99% or above for particles of 0.3μm or above



With the industry's first pre-cleaning function: namely pre-cleaning the workspace before sample treatment so as to further improve the protection of samples



The air cleanliness conforms to Class 5 of the ISO14644.1 Standard, and is better than Class 100 cleanliness requirements



#### One-key operation, convenient and secure:

- With a timed UV lamp turn off function, it is adjustable between 0 and 99 minutes

- With the lighting lamp and UV lamp interlock function; the UV lamp can only be lit when the lighting lamp is off. The UV lamp is turned off immediately if the fluorescent lighting is turned on to prevent mis-operation



Built-in lighting prevents exposure to fluorescent lamp to avoid eye stain

# Laminar Flow Cabinet

309/310



## Specifications

Model		HCB-900V	HCB-1300V	HCB-1600H		
General Specification	Flow Type	Vertical	Vertical	Vertical		
	Voltage/Frequency	220/50	115/60	220/50		
	Power (W)	1200	1200	1200		
	Vibration Amplitude (UM)	2	2	2		
	Exhaust Filter Typical Efficiency	H13 HEPA, 99.99% @ 0.3µm	H13 HEPA, 99.99% @ 0.3µm	H13 HEPA, 99.99% @ 0.3µm		
	Average Velocity (M/S)	0.2-0.4	0.2-0.4	0.2-0.4		
	Lighting Intensity (Lux)	≥300	≥300	≥300		
	Sound Level (dB(A))	60	60	60		
	Working Height of Front Window (mm)	Max 310	Max 310	Max 310		
	Dimensions	Net/Gross Weight	kg	115/145	145/171	145/171
lbs			254/319	320/376	320/376	363.7/471
Internal Dimensions (W*D*H)		mm	900*530*520	1300*530*520	1300*530*520	1710*550*750
		in	35.4*20.9*20.5	51.2*20.9*20.5	51.2*20.9*20.5	67.3*21.7*29.6
External Dimension (W*D*H)		mm	970*630*1730	1370*630*1730	1370*630*1730	1780*790*1960
		in	38.2*24.8*68.1	53.9*24.8*68.1	53.9*24.8*68.1	70.1*31.1*77.2
Packing Dimensions (W*D*H)		mm	1100*750*1290	1510*770*1280	1510*770*1280	1875*940*1410
		in	43.3*29.5*50.8	59.4*30.3*50.4	59.4*30.3*50.4	73.8*37.0*55.5
UV Lamp		Y	Y	Y	Y	
Power Outlet Socket		Y	Y	Y	/	
Conversion Socket	Optional	Optional	Optional	/		
Supporter	755mm (standard)	755mm (standard)	755mm (standard)	765mm (standard)		
Cleanliness Classification	ISO 14644.1 Class 5	ISO 14644.1 Class 5	ISO 14644.1 Class 5	ISO 14644.1 Class 5		
Container Load (20'40'40'H)	15/33/33	10/22/22	10/22/22	6/12/12		
Accessories	UV Lamp	Y	Y	Y	Y	
	Socket	1 Socket	1 Socket	1 Socket	Optional	
	Valve Port	Optional	Optional	Optional	Optional	
	Side Wall Service Taps	Optional gas tap, vacuum tap, compressed air tap and water tap	Optional gas tap, vacuum tap, compressed air tap and water tap	Optional gas tap, vacuum tap, compressed air tap and water tap	Optional gas tap, vacuum tap, compressed air tap and water tap	
	Antimicrobial Coating	Optional	Optional	Optional	Optional	
	316SS Work Surface	Optional	Optional	Optional	Optional	
	Work Surface	Single-piece	Single-piece	Single-piece	Single-piece	
	Touch Screen	/	/	/	/	
	Electric Front Sash	/	/	/	/	
	Foot Switch	/	/	/	/	
Others	Armrest	Y	Y	Y	Y	
	Exhaust Duct Connection Kits	/	/	/	/	
	Certification	CE	/	CE	CE	

\*Haier Biomedical reserves the right to change products and specifications without prior notice

# Laminar Flow Cabinet

311/312

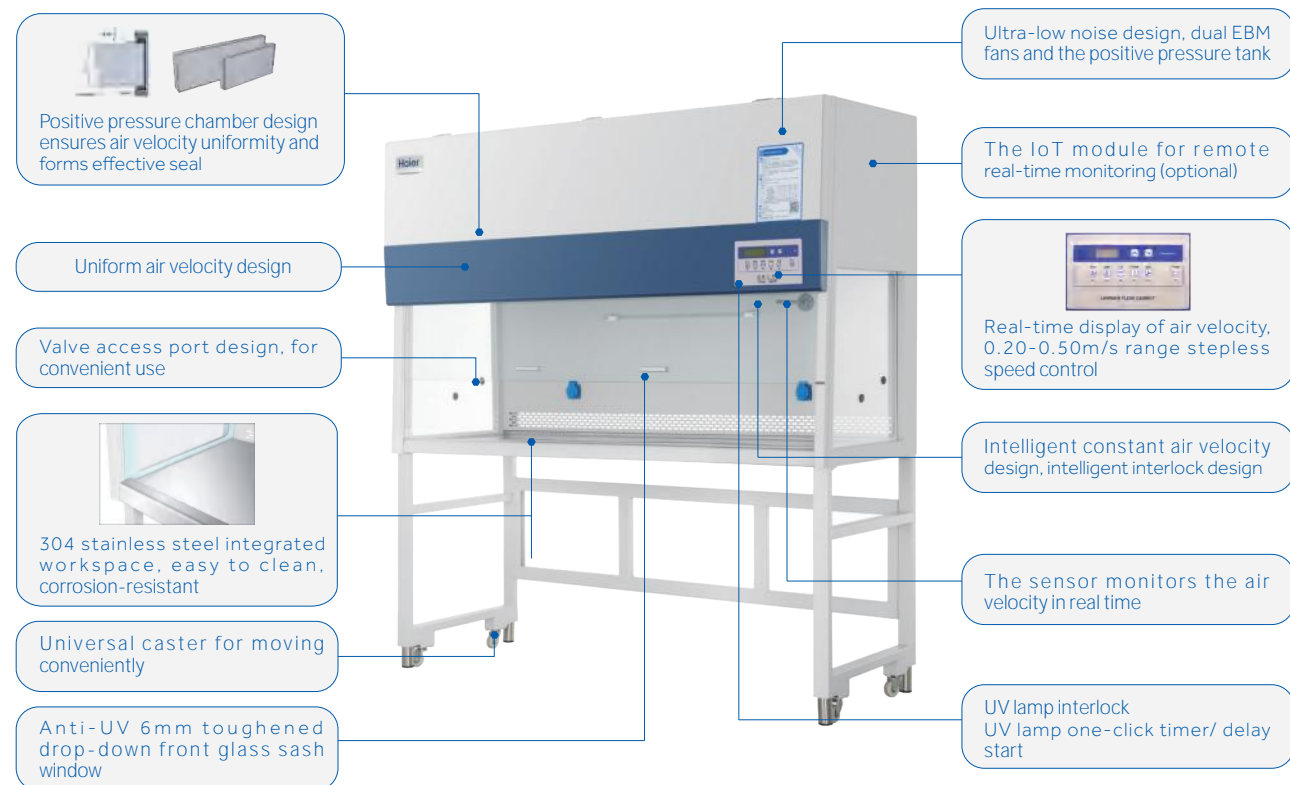

## Product Advantages

-  Positive pressure chamber design ensures air velocity uniformity and forms effective seal
-  Ergonomic cabinet design with a 10° inclination, to improve user comfort during operation
-  The workspace is made of easy-to-clean, high-quality, anti-corrosion 304 stainless steel
-  The front sash window and the left & right-side glass panels are all non-reflective tempered UV glass to maximise natural light during operation, which also makes the glass easy to clean
-  Designed with access ports on left and right sides, easy and convenient to mount valves such as gas supply

## Specifications

Model		HCB-900VS	HCB-1300VS	HCB-1600VS	
General Specification	Flow Type	Vertical	Vertical	Vertical	
	Voltage/Frequency	220/50/60	220/50/60	220/50/60	
	Power (W)	1200/1350	1350	1200/1350	
	Vibration Amplitude (UM)	2	2	2	
	Exhaust Filter Typical Efficiency	H13 HEPA, 99.99%@0.3um	H13 HEPA, 99.99%@0.3um	H13 HEPA, 99.99%@0.3um	
	Average Velocity (M/S)	0.20-0.50	0.20-0.50	0.20-0.50	
	Lighting Intensity (Lux)	≥400	≥600	≥1000	
	Sound Level (dB(A))	63	60	63	
Dimensions	Working Height of Front Window (mm)	Max 360	Max 360	Max 360	
	Net/Gross Weight	kg	140/166	180/232	202/260
		lbs	308.6/366	397/511.5	445.3/573
	Internal Dimensions (W*D*H)	mm	900*510*550	1300*510*550	1600*510*550
		in	35.4*20.1*21.7	51.2*20.1*21.7	60.0*20.1*21.7
	External Dimension (W*D*H)	mm	970*640*1820	1370*640*1820	1670*640*1820
		in	38.2*25.2*71.7	53.9*25.2*71.7	65.7*25.2*71.7
	Packing Dimensions (W*D*H)	mm	1083*772*1467	1480*845*1290	1780*840*1270
		in	42.6*30.4*57.8	58.3*33.3*50.8	70.1*33.1*50.0
	UV Lamp	Y	Y	Y	
Power Outlet Socket	Y	Y	Y		
Conversion Socket	Optional	Optional	Optional		
Supporter	750	750mm (standard)	750		
Cleanliness Classification	ISO 14644.1 Class 4	ISO 14644.1 Class 4	ISO 14644.1 Class 4		
Container Load (20'40'40'H)	15/32/32	11/20/20	7/14/14		
Accessories	UV Lamp	Y	Y	Y	
	Socket	1 socket	1 socket	1 socket	
	Valve Port	2 on each side	2 on each side	2 on each side	
	Side Wall Service Taps	Optional gas tap, vaccum tap, compressed air tap and water tap	Optional gas tap, vaccum tap, compressed air tap and water tap	Optional gas tap, vaccum tap, compressed air tap and water tap	
	Antimicrobial Coating	Optional	Optional	Optional	
	316SS Work Surface	Optional	Optional	Optional	
	Work Surface	Single-piece	Single-piece	Single-piece	
	Touch Screen	/	/	/	
	Electric Front Sash	/	/	/	
	Foot Switch	/	/	/	
	Armrest	Y	Y	Y	
	Exhaust Duct Connection Kits	/	/	/	
Others	Certification	NMPA	NMPA	NMPA	

\*Haier Biomedical reserves the right to change products and specifications without prior notice



# Ductless Fume Hood

313/314

## Scope of Application

This fume hood utilizes carbon filtration to protect laboratory personnel from toxic chemical fumes, odours, and particles. It is widely used within academia, public health, chemical and petrochemical industry, drug testing, museums and many other fields which involve the use of chemicals.



HTF-1200W/1500W

## Product Advantages



**10 inch touch screen**  
Real-time display of VOC concentration time, wind speed, filter and UV lamp running time. Alerts when filter or UV lamp lifespan falls below 10%



**EC fan**  
Energy-efficient EC fan for a longer service life and reliable and quieter operation.

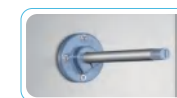

**Intelligent constant speed design**  
The air speed sensors adjust the fan speed through a microcomputer system so as to maintain constant air speed inside the cabinet.

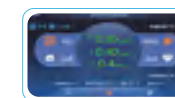

**TVOC detection**  
VOC probes detect the chemical concentration within both the cabinet workspace and filter. An audible and visual alarm will activate if conditions are unsafe.

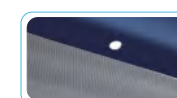

**PIR detection**  
In intelligent mode, the PIR sensor will detect when the operating area has been clear of personnel for more than 15 minutes and automatically switch to LNS green-saving mode.



**UV lamp**  
Patented one-button UV lamp technology allows users to automatically activate or deactivate based on usage habits or at specific sterilization intervals to minimise waiting time.



**Integral stand with universal caster and levelling feet**



**Intelligent IoT module (Optional)**  
Intelligent IoT module to enable the mobile APP to monitor the running state and display the performance parameters in real-time.

## Product Features

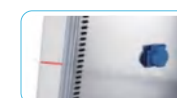

**Electrical sockets**  
Included as standard are two. Waterproof sockets with timing technology allows user to program timed on/off function.



**Ergonomic Design**  
The angled sash provides a clean view and more comfortable working position for operators.



**Adjustable height stand (optional)**



**Dual cameras monitoring (optional)**  
They can record individually the workspace around operating state.

## Specifications

Model	Operating Area Dimensions (W*D*H)(mm)	Exterior Dimensions (W*D*H)(mm)	Power Capacity (VA)	Fluorescent Lamp Power (W)	Noise (dB)	Inlet Wind Speed (m/s)	Certification
HTF-1200W	1230*760*655	1336*780*2120	1200	12V 18W*2	≤58	0.4-0.6	ASHRAE 110
HTF-1500W	1530*760*655	1636*780*2120	1300	12V 23W*2			

\*Haier Biomedical reserves the right to change products and specifications without prior notice.



# Incubators





Haier Biomedical IoT enabled CO<sub>2</sub> incubator with 180°C dry heat sterilization provides a safe and secure reproducible growth environment for cell cultures.



HCP-80

HCP-168

HCP-258

**IR Sensitive Control of CO<sub>2</sub> Concentration**

The new IR sensor with high temperature resistance of 190°C is based on the NDIR measurement principle and uses a silicon MEMS transmitter to replace the traditional light source. It can withstand more than 300 dry heat sterilization cycles with a service life of up to 15 years and control accuracy of ±0.1%. German IR infrared sensing technology, zero drift, without need for calibration, drift less than 0.3% within 2 years



**7-inch Touchscreen**

Displays CO<sub>2</sub> concentration and temperature data in real time. 15 years of data can be exported via USB

**6-sided heating sketch**

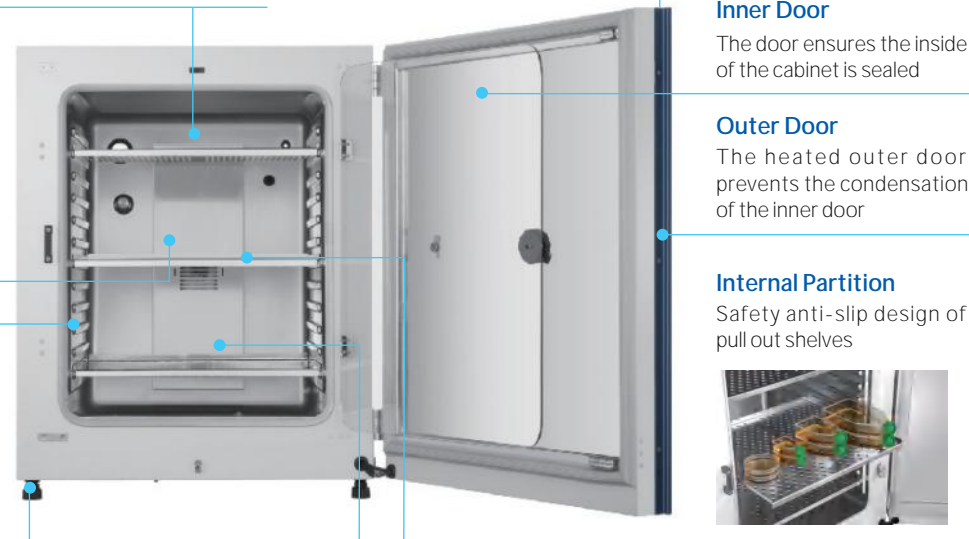
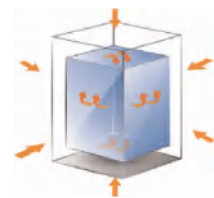

**Inner Door**

The door ensures the inside of the cabinet is sealed

**Outer Door**

The heated outer door prevents the condensation of the inner door

**Internal Partition**

Safety anti-slip design of pull out shelves



**304 Stainless Interior**



**Adjustable Feet**

It can be double stacked

**180°C Dry-heat Sterilization**

All internal components do not need to be disassembled and do not need separate autoclave sterilization to prevent secondary pollution. Cleaning consumables are not needed, one-button sterilization. German INFRARED CO<sub>2</sub> sensor, NDIR light source technology drift < 0.3% within two years. The unit can withstand sterilization at 180°C with no disassembly and no manual calibration

**Precise and Accurate Temperature Control**

Controls the temperature precisely, within ±0.1°C, with six-sided heating based on the fuzzy PID control principle, to provide a stable temperature to ensure the normal growth of cells throughout their life cycle.

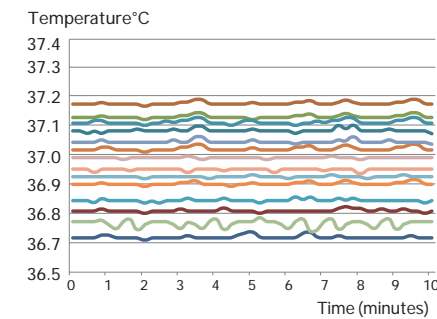

Uniformity of 27 measuring points <±0.3°C

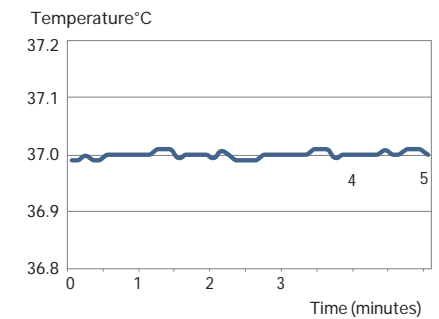

Central consistency point <±0.1°C

**Precise CO<sub>2</sub> Concentration Using New IR Sensor Control Technology**

Haier Biomedical's new IR Sensor technology uses NDIR measurement principles and withstands high temperatures of 190°C. The silicon MEMS transmitter can carry out more than 300 dry heat sterilization cycles to extend the service life to 15 years. Built-in temperature and humidity compensation technology reduces the impact of changes in humidity and temperature without the need for calibration after the high temperature sterilization. Five point calibration yields a higher measuring accuracy, sensitivity with less drift.

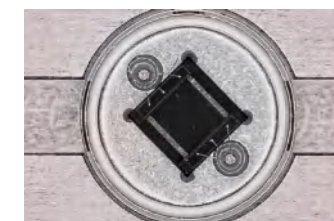

Silicon-based mems transmitter

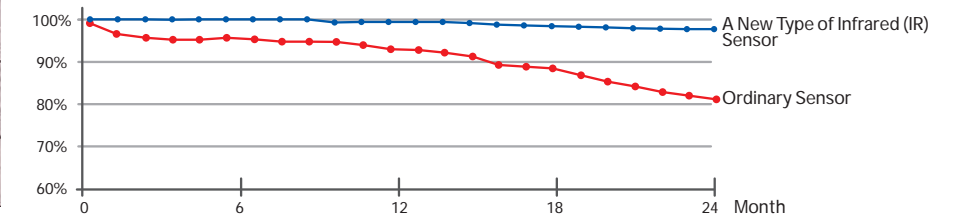

Sketch of drift less than 0.3%

**Fast Environment Recovery for Optimal Cell Growth**

Adopting active airflow control technology, and based on the fuzzy PID control principle, the parameters can be restored without overshoot. After opening the door for 30 seconds, the temperature and CO<sub>2</sub> concentration can be quickly restored within 4 minutes. Even if multiple users share a CO<sub>2</sub> incubator and frequently open and close the door, the stability and uniformity of the incubator can be ensured.

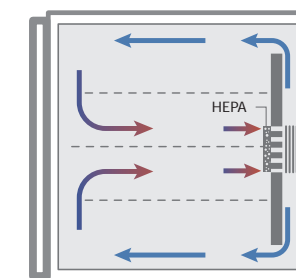
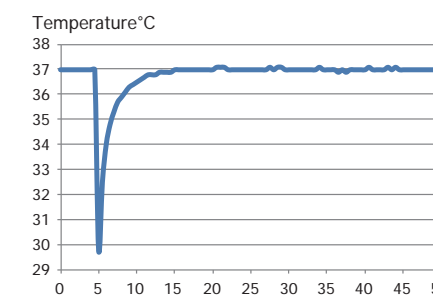
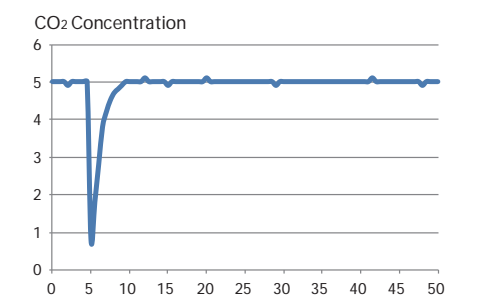

Illustration of purified airflow



Temperature recovery curve (door open for 30s)



CO<sub>2</sub> concentration recovery curve (door open for 30s)



### 180°C Dry-Heat Sterilization Technology Minimises Contamination

Easy and effective sterilization of microorganisms including bacteria, fungi and microplasma with strong resistance, at 180°C high temperatures without the need for consumables. Simply press the “sterilization key” to activate and complete the sterilization process automatically in just 12 hours.

Delivers sterility level within the chamber of all surfaces to meet WS/T367-2012 standards.

All components are sterilized during the process, there is no need to disassemble internal components (including CO<sub>2</sub> sensors) and decontaminate separately, thus avoiding secondary pollution.

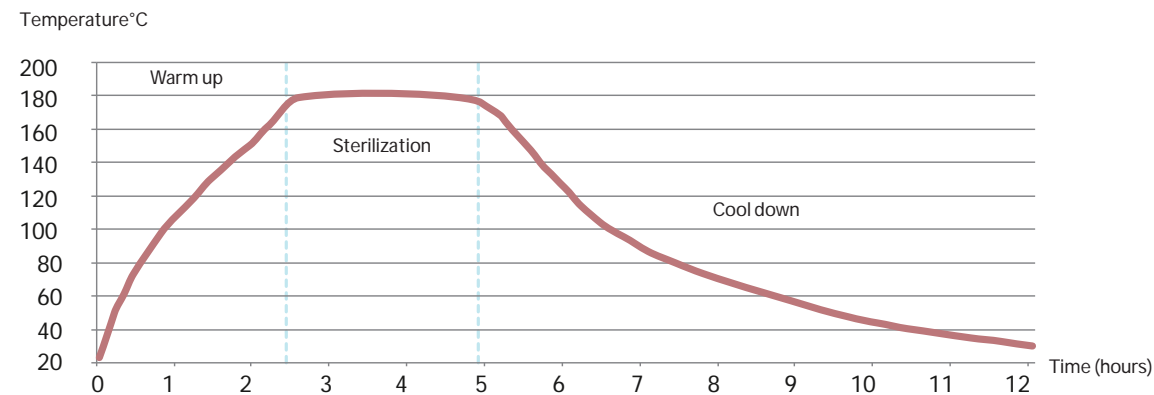

### High Efficiency Microbial Filter



The CO<sub>2</sub> inlet is equipped with a high-efficiency microbial filter, with 99.99% filtration efficiency for particles larger than or equal to 0.2µm in diameter. It can effectively filter bacteria and dust particles in the CO<sub>2</sub> gas line to ensure the safety of experimental results.

### Easy to Clean Interior

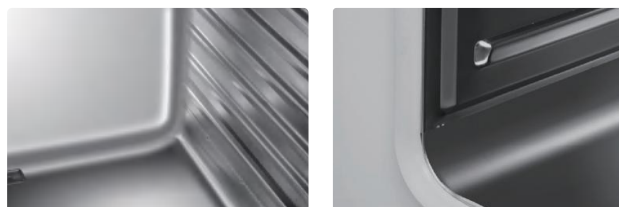

The working chamber is plasma electro polished, stamped stainless steel with wide-arc, laser welded corners. Bracketless shelving design ensures that it is quick and easy to clean.

### Interactive Intelligent Display with Easy Touch Operation

Touch-sensitive screen with rapid sensing even in rubber gloves. Green indicates normal operational parameters, while a red warning display indicates abnormal, making it easy to view data at a glance. A red warning display and audible buzzer will alarm when water level is low.



Home screen red warning.



Real-time display of operation data & real-time display of temperature, for CO<sub>2</sub> concentration and O<sub>2</sub> concentration, and the data during the culture cycle can be viewed at any time.



Announcement function designed for multiple persons to use the same incubator making it clear to all users on important matters.

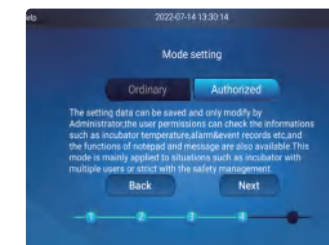

Operation mode clear management authority: three-levels of authority to ensure the security of data.

### Real-time Monitoring



An IoT module with multi-screen interface provides real-time uploadset parameters, operation parameters, operation curves, records and event records through the IoT cloud platform. The operation of incubator can be monitored at anytime and anywhere through mobile APP or computer terminal. Alarm function, and service function are available through an one button touch.

### Anti-Condensation Heating System to Reduce Pollution Risk

The door on the CO<sub>2</sub> incubator radiates heat to the inner glass door, effectively preventing the glass door from forming condensation. The possibility of microbial contamination caused by the condensate water is eliminated.

### Intelligent Control of Circulating Air Maintains Uniformity

Automatically adjusts the circulation of the air flow, optimizing the airflow to avoid air volatilization of samples and ensuring proper uniformity throughout the chamber.

### Comprehensive Safety Alarm System

The system ensures the safety of experiments and processes by utilizing an independent temperature alarm system, including a sound light and remote reminder. Other alarms include CO<sub>2</sub> concentration, door ajar and water shortage.

Innovative and User-friendly Design with Attention to Detail



Safe anti-slip design with pull out shelves.



Drainage design

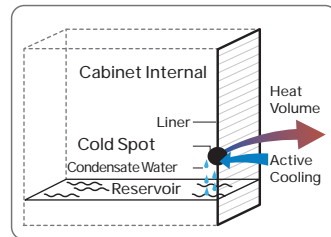

Active heat pipe condensation technology with any condensation directly returning to the reservoir.



Data traceable for 15 years with large storage capacity and data exportable through USB.

Accurate oxygen control (optional) for HCP-168

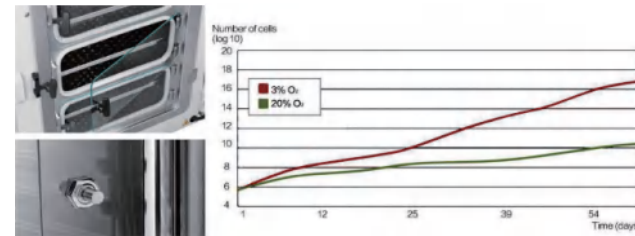

Three or six internal doors are available to reduce gas consumption  
 O<sub>2</sub> concentration can be controlled within the range of 1-21%  
 After opening the door for 30 seconds, the O<sub>2</sub> concentration can recover to 5% in only 8 minutes and 1% in 18 minutes  
 High precision zirconia O<sub>2</sub> sensor, oxygen control accuracy 0.1%  
 Advanced and reliable gas solenoid valve, low noise

The Quality of ISO Class 5 Clean Room Can Ensure a Better Cell Growth Environment

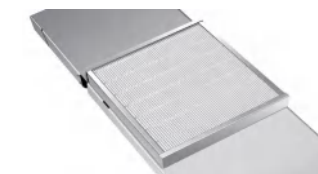

The optional HEPA high-efficiency filtration system combined with the unique air duct circulation design can continuously filter pollutants (biological pollutants and suspended particles) in the cabinet, ensuring that the incubator can reach the ISO class 5 clean room within 5 minutes after the external door is closed, which is equivalent to the class 100 environment of the 209 E standard of the united states

Optional Accessories

Name	Material Description
Oxygen module	Zirconia O <sub>2</sub> sensor, control accuracy: 0.1%; control range: 1-21% or +5-90%
3 Inner door (for HCP-168)	Reduce the temperature, humidity and carbon dioxide concentration in the box after opening the door, and minimize the mutual influence of multiple cultures
6 Inner door (for HCP-168)	Reduce the temperature, humidity and carbon dioxide concentration in the box after opening the door, and minimize the mutual influence of multiple cultures
8 Inner door (for HCP-258)	Reduce the temperature, humidity and carbon dioxide concentration in the box after opening the door, and minimize the mutual influence of multiple cultures
Water tray	Provides different bottom humidification methods
Roller base	Easy to move, prevent the ground bacteria contamination
HEPA filter	Ensure the cleanliness of the cabinet, suitable for users who open and close the door frequently; After opening the door for 30 seconds, the air inside the cabinet can be passed through HEPA filters within 5 minutes and reach ISO 5 clean room quality
Pressure reducing valve	Suitable for users with cylinder gas supply
Shelf	Increase the number of samples cultured 4 materials: SUS304 single mirror surface SUS304 double mirror surface tempering glass 100% Pure copper
Cylinder switching	Supports switching between multiple steel cylinders to ensure uninterrupted air intake into the incubator
Electromagnetic lock	Important tests can be dedicated by dedicated personnel to ensure test safety
Stacking bracket	Supports stacking of different volume models up and down, saving laboratory space

Specifications

Model	HCP-80	HCP-80B	HCP-168	HCP-168B	HCP-258	HCP-258B	
Type	Air Jacket		Air Jacket		Air Jacket		
Construction	Chamber Volume (L)	80	170		258		
	Interior Chamber	304 Stainless Steel					
	Exterior Chamber	Cold-rolled steel powder coated					
	Access Port	/	35mm Diameter		35mm Diameter		
	Data Outputs	Remote Alarm Contacts, USB, and Optional 4-20mA					
Dimensions	Net/Gross Weight (approx)	kg	75/95	95/130	110/155		
		lbs	165.3/209.4	209.4/286.6	242.5/341.7		
	Interior Dimensions (W*D*H)	mm	400*420*490	490*560*650		570*610*745	
		in	15.7*16.5*19.3	19.3*22*25.6		22.4*24.0*29.3	
	Exterior Dimensions (W*D*H)	mm	625*684*735	714*812*887		794*867*985	
		in	24.6*26.9*28.5	28.1*32*34.9		31.3*34.1*38.8	
Packing Dimensions (W*D*H)	mm	700*770*910	890*800*1050		870*950*1150		
	in	27.6*30.3*35.8	35*31.5*41.3		34.3*37.4*45.3		
Shelves	Dimensions (W*D)	mm	380*300	473*434	550*484		
	Number Standard/Maximum		3/8	3/11	3/13		
	Max.Load Per Shelf/Total Load	kg	15/45	15/45	15/45		
	Construction		Perforated, Adjustable				
Electrical	Rated Voltage Power Supply (V/Hz)	220-240-50/60	115/60	220-240-50/60	115/60	220-240-50/60	
	Steri-Run Consumption (kw)	0.08 (0.75)		0.095 (1.1)		0.12 (1.2)	
Control	Heat Emission to Environment at 37°C	0.06KWh/h		0.075KWh/h		0.1KWh/h	
	Controller	Microprocessor		Microprocessor		Microprocessor	
	Display	7"LCD Screen		7"LCD Screen		7"LCD Screen	
CO <sub>2</sub>	Control Accuracy	0.1%		0.1%		0.1%	
	Range	0-20%		0-20%		0-20%	
	Alarm Range	±0.5%		±0.5%		±0.5%	
	Inlet Pressure	12-17Psi (0.8-1.2 Bar)					
	Gas Purity	≥99.5%					
	Sensor	IR		IR		IR	
	Recovery Time at 5vol. -%/CO <sub>2</sub> for a 30 Second Door Opening* (min)	4		4		4	
	CO <sub>2</sub> Inlet Filter (µm)	<0.2		<0.2		<0.2	
	Control	0.1%		0.1%		0.1%	
	Range	1-21%		1-21%/+5-90%		1-21%	
O <sub>2</sub> (Optional)	Tracking Alarm	±0.5%		±0.5%		±0.5%	
	Inlet Pressure	0.08-0.12MPa		0.08-0.12MPa		0.08-0.12MPa	
	Gas Purity	Min.99.5		Min.99.5		Min.99.5	
	O <sub>2</sub> Inlet	1/8" hose (barbed)		1/8" hose (barbed)		1/8" hose (barbed)	
Alarms	High/Low Temperature	Y		Y		Y	
	Remote Alarm	Y		Y		Y	
	Excessive CO <sub>2</sub> Concentration	Y		Y		Y	
	Water Shortage	Y		Y		Y	
	Sensor Error	Y		Y		Y	
	Door Ajar	Y		Y		Y	
Temperature Parameter	Control Accuracy (°C)	0.1		0.1		0.1	
	Range	Ambient temperature+3-55°C					
	Uniformity (°C)	±0.3		±0.3		±0.3	
	Ambient Range (°C)	18-34		18-34		18-34	
	Sensor	2PT1000		2PT1000		2PT1000	
Sterilization Cycle	Recovery Time at 37°C for a 30 Second Door Opening* (min)	4		4		4	
	Cycle Temperature	180°C on internal Surfaces and Shelves					
Humidity	Cycle Duration	Under 12 Hours		Under 12 Hours		Under 12 Hours	
	RH (Relative Humidity)	Setting 37°C ≥90%		Setting 37°C ≥90%		Setting 37°C ≥90%	
	Humidity Reservoir	Max.1.5L/min 0.5L		Max.3.5L/min 0.5L		Max.5.5L/min 0.5L	
Option	HEPA Filter	Y		Y		Y	
	Pressure Reducing Valve	Y		Y		Y	
	4-20mA	Y		Y		Y	
	The Cylinder Switch	Y		Y		Y	
	Shelf	Y		Y		Y	
	Water Tray	Y		Y		Y	
	3 Inner Door	N		Y		N	
	6 Inner Door	N		Y		N	
8 Inner Door	N		N		N		
Others	Oxygen Module	Y		Y		Y	
	Certification	CE	UL	CE	UL	CE	



**Precise and Accurate Temperature Control**

Controls the temperature precisely, within ±0.1°C, with six-sided heating based on the fuzzy PID control principle, to provide a stable temperature to ensure the normal growth of cells throughout their life cycle.

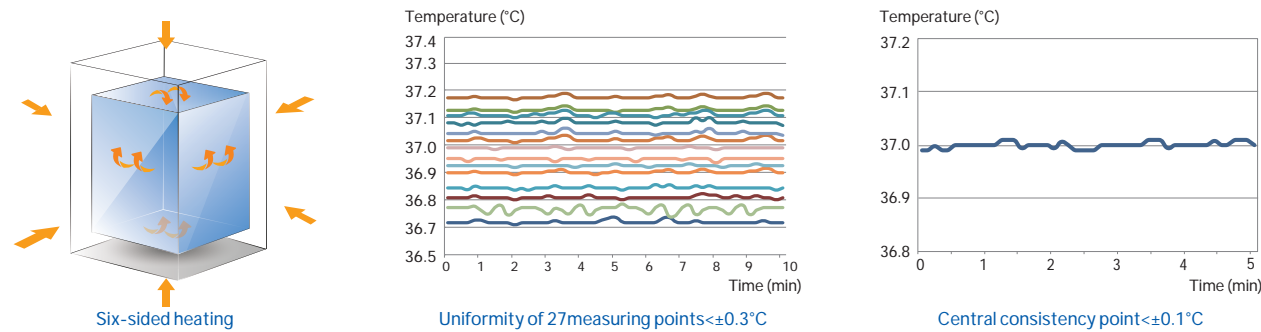

**Precise CO<sub>2</sub> Concentration Using New IR Sensor Control Technology**

Haier Biomedical's new IR Sensor technology uses NDIR measurement principles and withstands high temperature of 100°C. The silicon MEMS transmitter can carry out more than 300 dry heat sterilization cycles to extend the service life to 15 years. Built-in temperature and humidity compensation technology reduce the impact of changes in humidity and temperature without the need for calibration after the high temperature sterilization. Five points calibration yields a higher measuring accuracy, sensitivity with less drift (less than 3% within 2 years).



Silicon-based mems transmitter

Infrared (IR) sensor

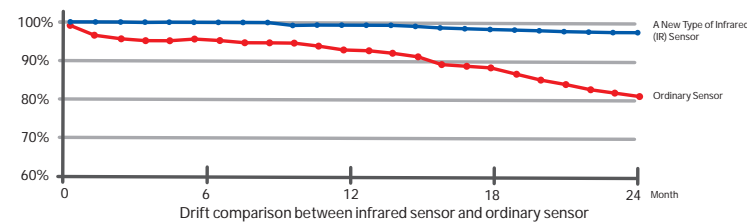

**Fast Environment Recovery for Optimal Cell Growth**

Adopting active air flow control technology, based on the fuzzy PID control principle, the parameters can be restored without overshoot. After opening the door for 30 seconds, the temperature and CO<sub>2</sub> concentration can be quickly restored within 4 minutes. Even if multiple users share a CO<sub>2</sub> incubator and frequently open and close the door, the stability and uniformity of the incubator can be ensured.

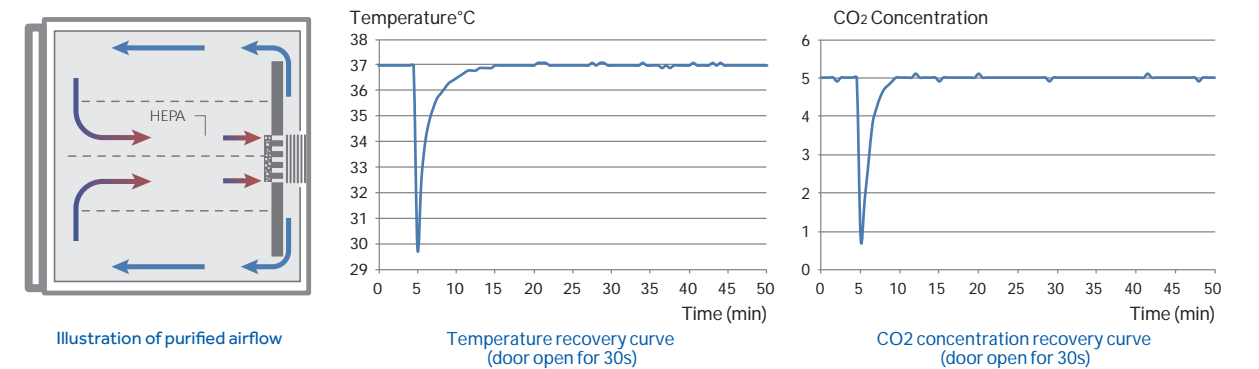

**90°C Moist Heat Sterilization Technology**

Effective sterilization of microorganisms including bacillus and spores with strong resistance, at 90°C under moist heat, without the need for consumables. Simply press the "sterilization button", to activate and complete the sterilization process automatically in 14 hours.

Delivers sterility level within the chamber of all surfaces to meet WS/T367-2012 standards.

All components are sterilized during the process, there is no need to disassemble internal components (including CO<sub>2</sub> sensors) and decontaminate separately, thus avoiding secondary pollution.

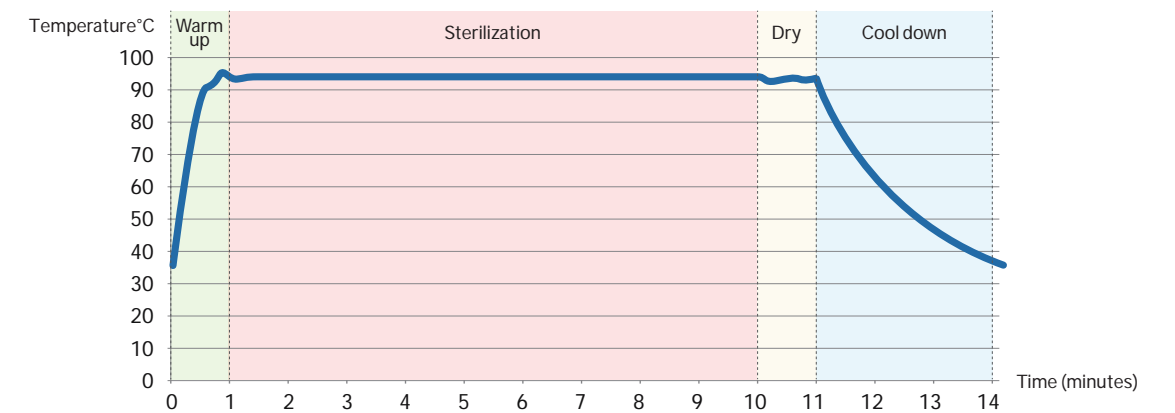

**Sterilization Temperature Profile**

Forty-seven points were tested in the working chamber, including glass inner doors and partitions. All regions reached 90°C and maintained for 9 hours.

\*The equipment is tested by Haier in a controlled environment. Haier does not guarantee that the results of field tests under different conditions will be consistent. The test model is HCP-168E

\*The equipment is tested by Haier in a controlled environment. Haier does not guarantee that the results of field tests under different conditions will be consistent. The test model is HCP-168E



**Air Jacketed With Six-sides Heating Design**

- Fast temperature recovery and superior temperature uniformity
- High temperature sterilization can ensure that the temperature of each surface can reach 90°C

**Co<sub>2</sub> Sensor**

- The new IR sensor with high temperature resistance of 100°C, can withstand more than 300 high heat sterilization cycles
- Based on the NDIR measurement principle and uses a silicon MEMS transmitter to replace the traditional light source
- Zero drift and without need for calibration

**Inner Door**

- Tempered glass provides easy observation of sample growth
- Three/six inner doors optional

**Operation Panel**

- 4-inch LCD screen, vivid display and easy operation
- Abnormal operation sound and light alarm to ensure sample safety
- Running data can be traced, large capacity storage, data can be exported through USB

**Door Switch**

When the door opens, heating, air intake and fan automatically stop to minimize the risk of cross contamination

**Partition**

- Anti-slip design
- High levelness ensures uniform growth of adherent cells
- Mirror stainless steel to ensure high surface cleanliness, easy to clean

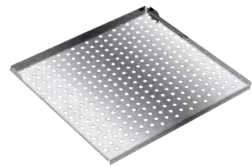
**Air Flow System**

The air flow circulation ensures proper uniformity throughout the chamber

**Integrated Liner**

Integral design, large arc design, easy to clean

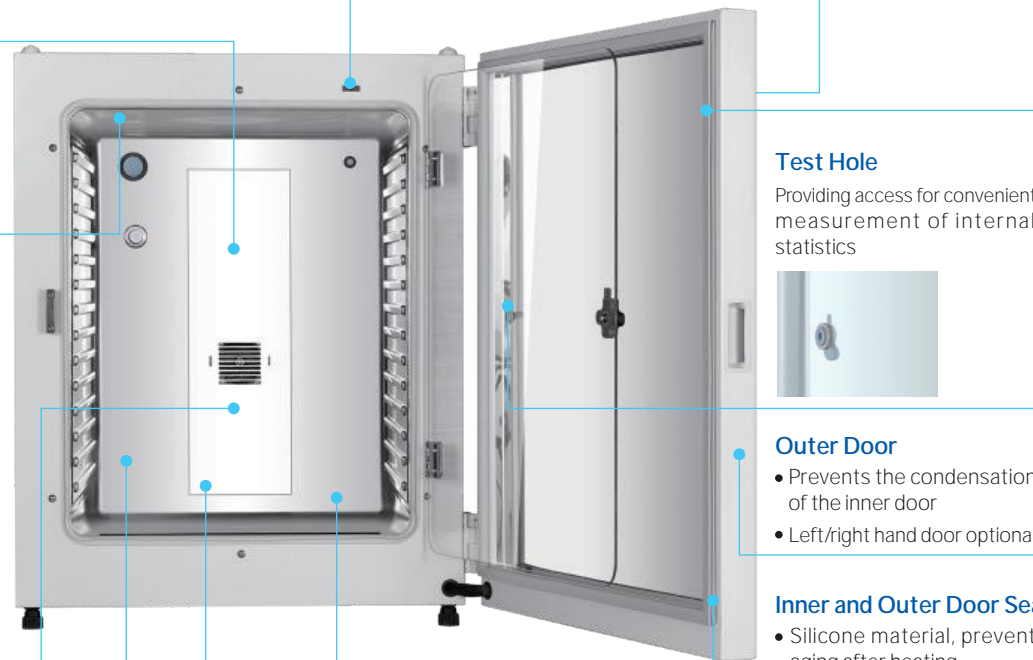
**Test Hole**

Providing access for convenient measurement of internal statistics

**Outer Door**

- Prevents the condensation of the inner door
- Left/right hand door optional

**Inner and Outer Door Seal**

- Silicone material, prevent aging after heating
- Close the inner cavity to ensure the cleanliness and uniformity of the inner chamber

**Bottom Reservoir Humidification**

- Reservoir humidification method, no water tray, easy to clean, avoid breeding bacteria
- Large evaporation area and fast humidity recovery

**Easy to Clean Interior**

The working chamber is plasma electro polished, stamped stainless steel with wide-arc, laser welded corners. Bracketless shelving design ensures that it is quick and easy to clean.

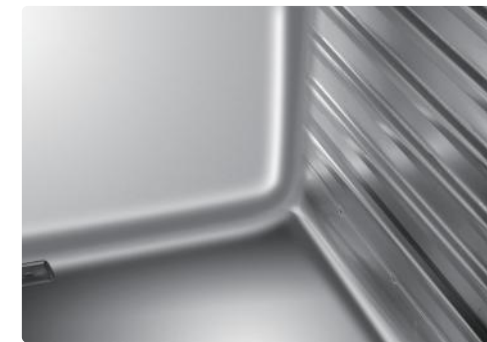
**Innovative Design with Attention to Detail**

Safe anti-slip design of pull-out shelves.

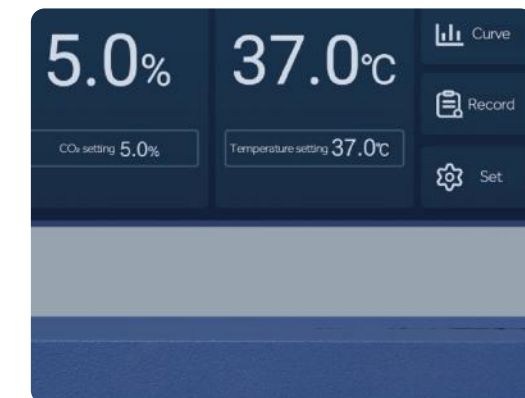

Data traceable for 15 years with large storage capacity and data exportable through USB.

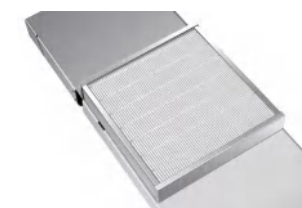
**The Quality of ISO Class 5 Clean Room Can Ensure a Better Cell Growth Environment**

The optional HEPA high-efficiency filtration system combined with the unique air duct circulation design can continuously filter pollutants (biological pollutants and suspended particles) in the cabinet, ensuring that the incubator can reach the ISO class 5 clean room within 5 minutes after the external door is closed, which is equivalent to the class 100 environment of the 209 E standard of the united states

## Reservoir Humidification Without Condensation

Active heat pipe condensation technology with condensate water directly returns to the reservoir, to ensure no condensation.

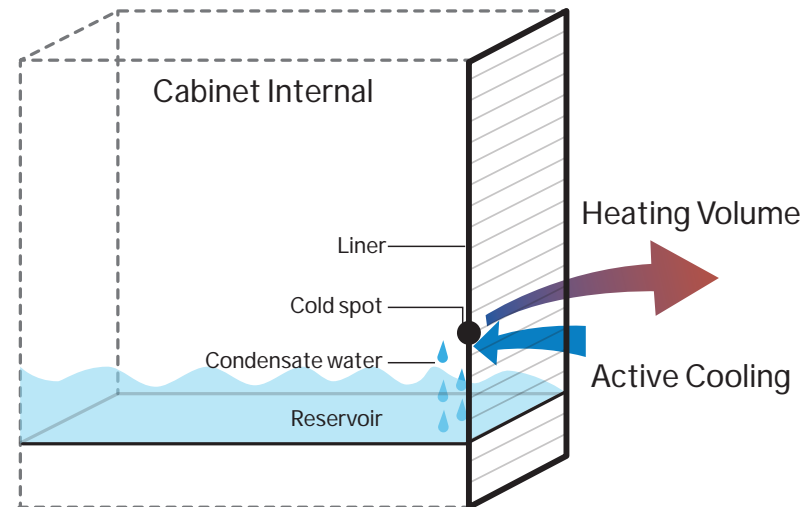

## Optional Accessories

Name	Material Description
Oxygen module	Zirconia O <sub>2</sub> sensor, control accuracy: 0.1%; control range: 1-21% or +5-90%
3 Inner door (for HCP-168)	Reduce the temperature, humidity and carbon dioxide concentration in the box after opening the door, and minimize the mutual influence of multiple cultures
6 Inner door (for HCP-168)	Reduce the temperature, humidity and carbon dioxide concentration in the box after opening the door, and minimize the mutual influence of multiple cultures
8 Inner door (for HCP-258)	Reduce the temperature, humidity and carbon dioxide concentration in the box after opening the door, and minimize the mutual influence of multiple cultures
Water tray	Provides different bottom humidification methods
Roller base	Easy to move, prevent the ground bacteria contamination
HEPA filter	Ensure the cleanliness of the cabinet, suitable for users who open and close the door frequently; After opening the door for 30 seconds, the air inside the cabinet can be passed through HEPA filters within 5 minutes and reach ISO 5 clean room quality
Pressure reducing valve	Suitable for users with cylinder gas supply
Shelf	Increase the number of samples cultured 4 materials: SUS304 single mirror surface SUS304 double mirror surface tempering glass 100% Pure copper
Cylinder switching	Supports switching between multiple steel cylinders to ensure uninterrupted air intake into the incubator
Electromagnetic lock	Important tests can be dedicated by dedicated personnel to ensure test safety
Stacking bracket	Supports stacking of different volume models up and down, saving laboratory space

## Specifications

Model		HCP-80E	HCP-168E	HCP-258E	
Type		Air Jacket	Air Jacket	Air Jacket	
Construction	Chamber Volume (L)	80	170	258	
	Interior Chamber	Stainless Steel			
	Exterior Chamber	Cold-rolled Steel Powder Coated			
	Access Port	/	35mm Diameter	35mm Diameter	
	Data Outputs	Remote Alarm Contacts, USB, and Optional 4-20mA			
Dimensions	Net/Gross Weight (approx)	kg	75/100	95/130	
		lbs	165/220	209.4/286.6	
	Interior Dimensions (W*D*H)	mm	400*420*490	490*560*650	570*610*745
		in	15.7*16.5*19.3	19.3*22*25.6	22.4*24.0*29.3
	Exterior Dimensions (W*D*H)	mm	625*684*735	714*812*887	794*867*985
		in	24.6*26.9*28.5	28.1*32*34.9	31.3*34.1*38.8
Packing Dimensions (W*D*H)	mm	765*710*930	760*840*1050	950*880*1145	
	in	30*28*36.6	29.9*33.1*41.3	37.4*35*45	
Shelves	Dimensions (W*D)	mm	380*300	473*434	550*484
	Number Standard/Maximum		3/8	3/11	3/13
	Max. Load Per Shelf/Total Load	kg	15/45	15/45	15/45
	Construction		Perforated, Adjustable	Perforated, Adjustable	Perforated, Adjustable
Electrical	Rated Voltage Power Supply (V/Hz)		220-240V-50/60	220-240V-50/60	220-240V-50/60
	Steri-Run Consumption (kw)		0.07 (0.9)	0.095 (1.0)	0.12 (1.6)
Control	Heat Emission to Environment at 37°C		0.065KWh/h	0.065KWh/h	0.11KWh/h
	Controller		Microprocessor	Microprocessor	Microprocessor
CO <sub>2</sub>	Display		4 Inch LED Button Screen	4 Inch LED Button Screen	4 Inch LED Button Screen
	Control Accuracy		0.10%	0.10%	0.10%
	Range		0-20%	0-20%	0-20%
	Alarm Range		±0.5%	±0.5%	±0.5%
	Inlet Pressure		12-17PSI (0.8-1.2bar)	12-17PSI (0.8-1.2bar)	12-17PSI (0.8-1.2bar)
	Gas Purity		≥99.5%	≥99.5%	≥99.5%
	Sensor		IR	IR	IR
	Recovery Time at 5vol. -%/CO <sub>2</sub> for a 30 Second Door Opening* (min)		4	4	4
	CO <sub>2</sub> Inlet Filter (µm)		0.2	0.2	0.2
	Control		0.1%	0.1%	0.1%
O <sub>2</sub> (Optional)	Range		1-21%	1-21%	1-21%
	Tracking Alarm		±0.5%	±0.5%	±0.5%
	Inlet Pressure		0.08-0.12MPa	0.08-0.12MPa	0.08-0.12MPa
	Gas Purity		Min.99.5	Min.99.5	Min.99.5
Alarms	O <sub>2</sub> Inlet		1/8" Hose (barbed)	1/8" Hose (barbed)	1/8" Hose (Barbed)
	High/Low Temperature		Y	Y	Y
	Remote Alarm		Y	Y	Y
	Excessive CO <sub>2</sub> Concentration		Y	Y	Y
	Water Shortage		Y	Y	Y
	Sensor Error		N	N	N
	Door Ajar		Y	Y	Y
Temperature Parameter	Control Accuracy (°C)		0.1	0.1	0.1
	Range		Ambient Temperature +3-55°C		
	Uniformity (°C)		±0.3	±0.3	±0.3
	Ambient Range (°C)		18-34	18-34	18-34
	Sensor		PT1000	PT1000	PT1000
Sterilization Cycle	Recovery Time at 37°C for a 30 Second Door Opening* (min)		4	4	4
	Cycle Temperature		90	90	90
Humidity	Cycle Duration		14	14	14
	RH (Relative Humidity)		High Humidity ≥90%, Low Humidity ≥80%		
Option	Humidity Reservoir		Max.3L/Min 0.5L	Max.3L/Min 0.5L	Max.3L/Min 0.5L
	HEPA Filter		Y	Y	Y
	Pressure Reducing Valve		Y	Y	Y
	4-20mA		Y	Y	Y
	The Cylinder Switch		Y	Y	Y
	Shelf		Y	Y	Y
	Water Tray		Y	Y	Y
	3 Inner Door		N	Y	N
	6 Inner Door		N	Y	N
	8 Inner Door		N	N	Y
Others	Oxygen Module		Y	Y	N
	Certification		CE	CE	CE

# Standard Incubator

329/330

## Scope of Application

The solution is widely used in bacteria, fungi and other microorganism cultures; as well as enzyme digestion reaction, ligation reaction, embedded incubation and other related constant temperature experiments.



Embedded incubation

Bacteria

Fungus



HZP-168

HFP-80

## Product Advantages



### Personalized interface, easy to link

Equipped with USB and RS485 interfaces to meet the different needs of users to transfer data



### Multiple protection benefits for increased security

Overheat protection (OPT), over current protection (FU), sensor error detection, independent temperature limit, compliance with DIN 12880 requirements and EU 3.1 safety level. Sound, light and remote alarms (optional) which guarantee experiment safety. Multiple alarms, such as over temperature alarm, high and low temperature alarm, door ajar, and sensor error alarm



### Data traceability

Data traceable up to 15 years with base storage 8GB and data exportable through USB



### High thermal insulation performance, energy saving and environmental protection

The unit is manufactured with aluminum foil insulation cotton, which improves the overall insulation performance and reduces energy consumption, lowering costs while also being environmentally friendly

## Fuzzy PID Control Technology



HZP-168  
Natural Convection

HFP-80  
Forced Convection

ASTM standard,  
12 points testing

Based on PID control principle, manufactured with U-shaped 3-sided heating to achieve superior temperature control and uniformity control.

## Rapid Recovery After Door Open

Rapid warming: the temperature inside the unit quickly recovers after opening the door to reduce the influence of temperature fluctuation on the sample.

The temperature rise curve to 37°C after opening the door for 30 sec at 22°C ambient temperature

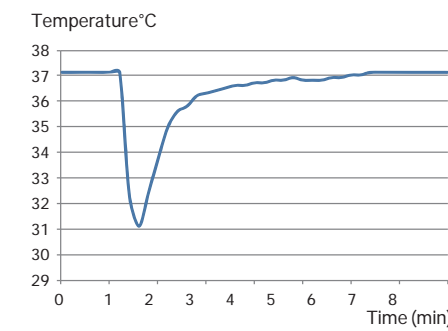

HZP-168

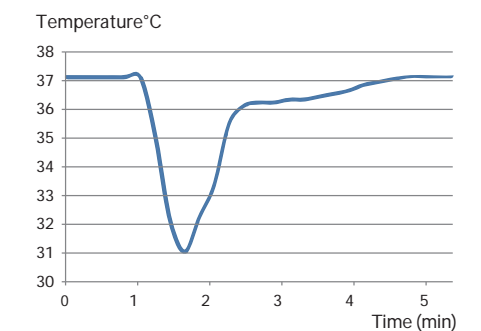

HFP-80

## Convenient and Intelligent Management at a Glance

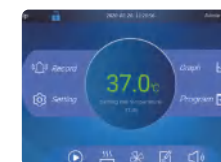

7-inch touchscreen, easy to operate and sensitive, it can respond quickly even when wearing rubber gloves.



Real-time display of temperature data, one-touch to review previous data.

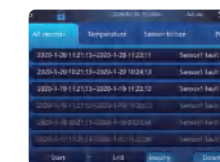

Records abnormal information in real time, eliminating any hidden abnormalities which ensures the culturing is more secure.

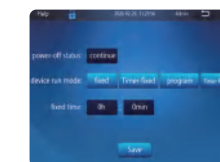

Multiple operating modes.



The program can be edited and set at any number of segments to meet the needs of various detection tests.



# Standard Incubator

## Precise Temperature Control, Energy-efficient and Environment-friendly

An energy-efficient model with superior control and heating mechanisms, high-quality insulation material and cabinet structure to ensure heating requirements are met while keeping power consumption to a minimum.

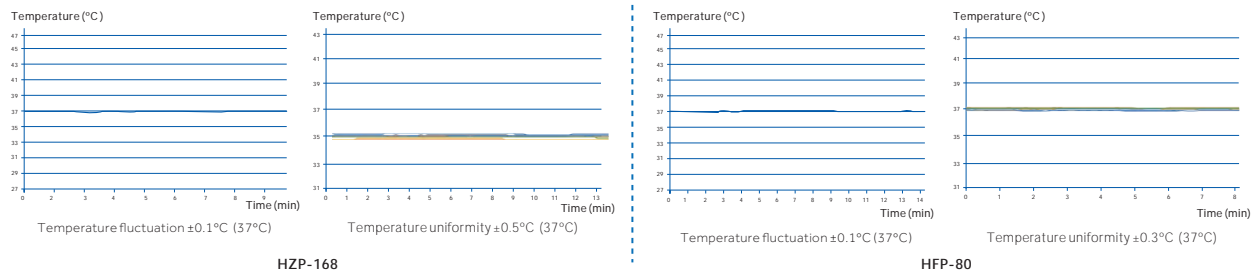

## Optional IoT Technology for Real-time Remote Monitoring



Through the mobile app, the status of the incubator can be checked in real time, and information such as temperature alarm, sensor error alarm and door ajar can be controlled with one button, which provides more security for the experiment process.

## Pictures in Details



Seamless, curved internal chamber for easy cleaning and decontamination.



Standard independent intelligent temperature safety controller to ensure experimental safety; RS485 achieves seamless IoT data connection.

## Product Parameters

Model	Product Series	Capacity (L)	Power (W)	Exterior Dimensions (W*D*H)(mm)	Interior Dimensions (W*D*H)(mm)	Packing Dimensions (W*D*H)(mm)
HZP-168	Natural convection	168	640	650*782*1028	490*550*626	795*835*1220
HFP-80	Forced convection	80	510	560*662*870	400*400*480	710*760*1070

Shelves (Standard)	Temperature Control Range	Temperature Uniformity	Temperature Fluctuation (°C)	Temperature Control Precision (°C)	Recovery Time after 30 sec Door Opening (min)
2/17	RT+5-105°C	±0.5°C at 37°C	±0.1	±0.1	5
2/12	RT+5-105°C	±0.3°C at 37°C	±0.1	±0.1	2.5

Product appearance and specifications are subject to change without notice

## Scope of Application

Widely used for bacteria, fungi and microorganism cell culture as well as enzyme digestion reaction, ligation reaction, embedded incubation and other related constant temperature experiments



HZP-168E

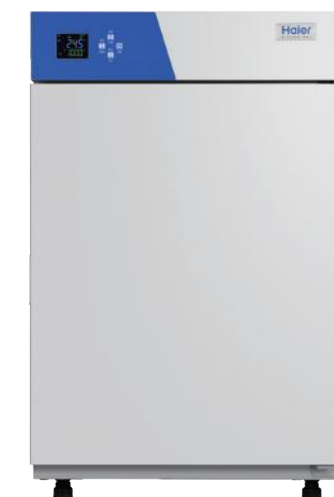

HFP-80E

## Product Advantages



### Multiple Security Protection

Multiple protection systems such as overheating, overcurrent, and independent temperature limiting; overtemperature, high and low temperature and other smart alarms for safety



### Smart IoT Module (optional)

Through the mobile app, the status of the incubator can be checked in real-time



### Broad Temperature Range

Temperatures from 5°C above ambient up to 105°C



### High Thermal Insulation Performance

Superior insulation that improves chamber stability and reduces heat load output to the laboratory and operating power consumption, that lowers operating costs



### Ergonomic Design

Efficient utilization of interior with flexible shelf system



### 4-inch Display Screen

The real-time display of the set temperature and running temperature makes the operation more convenient



### 100°C Decontamination

The disinfection routine at 100°C minimizes the risk of contamination

Precise Temperature Control

Validated through ASTM standard 12 points temperature detection method, the incubator can achieve high-precision temperature control with a temperature fluctuation of only  $\pm 0.1^{\circ}\text{C}$

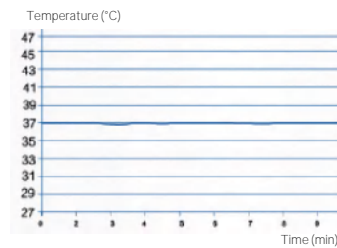
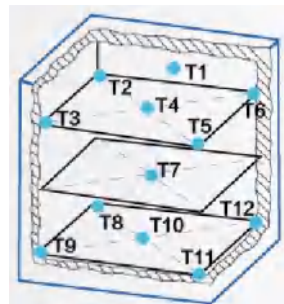

Temperature fluctuations  $\pm 0.1^{\circ}\text{C}$   
(HZP-80E)

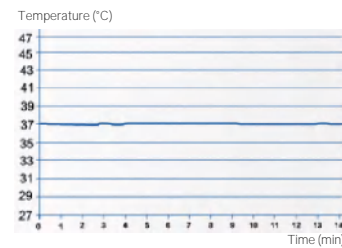

Temperature fluctuations  $\pm 0.1^{\circ}\text{C}$   
(HFP-168E)

Rapid Temperature Recovery After Door Open

The U-shaped 3-sided heating design enables the incubator to heat up quickly. After opening the door for 30 seconds, the temperature inside the chamber recovers to the set value within 3 minutes, significantly reducing the impact of temperature fluctuations on the experiments

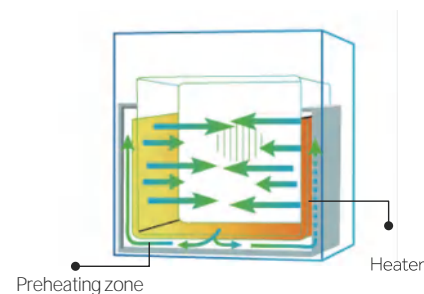

4-inch LED screen with simple operation and clear display



Standard independent intelligent temperature safety controller to ensure experimental safety



Smooth inner chamber with easy to clean rounded corners



Adjustable feet for easy positioning and levelling



Product Parameters

Model	Capacity (L)	Temperature Setting Range (°C)	Temperature Control Precision (°C)	Temperature Uniformity	Temperature Fluctuation (°C)	Recovery Time after 30 sec Door Opening (min)
HFP-168E	168	RT+5-105	$\pm 0.1$	$\pm 0.3^{\circ}\text{C}$ at $37^{\circ}\text{C}$	$\pm 0.1$	3
HZP-80E	80	RT+5-105	$\pm 0.1$	$\pm 0.5^{\circ}\text{C}$ at $37^{\circ}\text{C}$	$\pm 0.1$	2.5

Animal and plant tissue culture, drug stability tests, cosmetic stability tests, food shelf life tests, electronic components aging tests, packaging material stability tests.



HHS-256/756/506

Product Advantages



**Silent**  
Semiconductor technology ensures low vibration and noise output with no pollution into the environment



**Water-saving**  
Intelligent control of PTC humidification, daily water consumption of 120-320ml, no need to recycle waste water, saving space











**Precise control**  
Accurate temperature and humidity control, long-term stability,  $40^{\circ}\text{C}$  temperature uniformity  $\pm 0.5^{\circ}\text{C}$  and central temperature fluctuation  $\pm 0.2^{\circ}\text{C}$ , 75% humidity fluctuation  $\pm 1\%$



**Power saving**

Product Features

-  Multiple protection protocols - equipped with delay start, high/low temperature and light intensity protection in line with DIN12880 requirement for over/under temperature protection
-  High precision temperature sensor, dual PT1000 sensors for more accurate temperature control
-  Optional electromagnetic lock, suitable for multiple users with independent management for safety
-  Polyurethane foam insulation provides excellent thermal insulation, reducing energy consumption
-  **Microprocessor control system**
  - PID control principle, 10-inch touch screen, temperature control precision 0.1°C, humidity control precision 0.1%, temperature range 5-70°C, humidity range 10%-90%
  - USB, RS485 interface as standard
-  Expandable large capacity data storage, the touchscreen memory can be expanded to 64GB, storing up to 15 years data which can be exported via a USB
-  An access port with a diameter of 35mm on the left side of the cabinet to facilitate independent testing of temperature and humidity
-  High insulating performance polythene foam provides excellent insulation and stable cabinet temperatures reducing energy consumption
-  High precision capacitive humidity sensor
- Temperature alarm, humidity alarm, door alarm, sensor alarm and water shortage warning
  - Display temperature, humidity and ambient temperature; users can query the historical curve

International Quality Assurance

Accurate Temperature Control

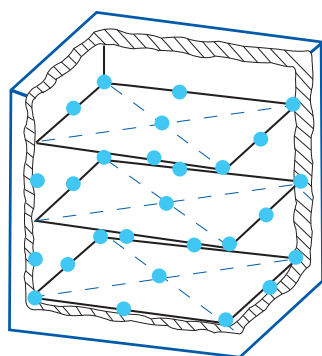

DIN12880 standard 27 test points

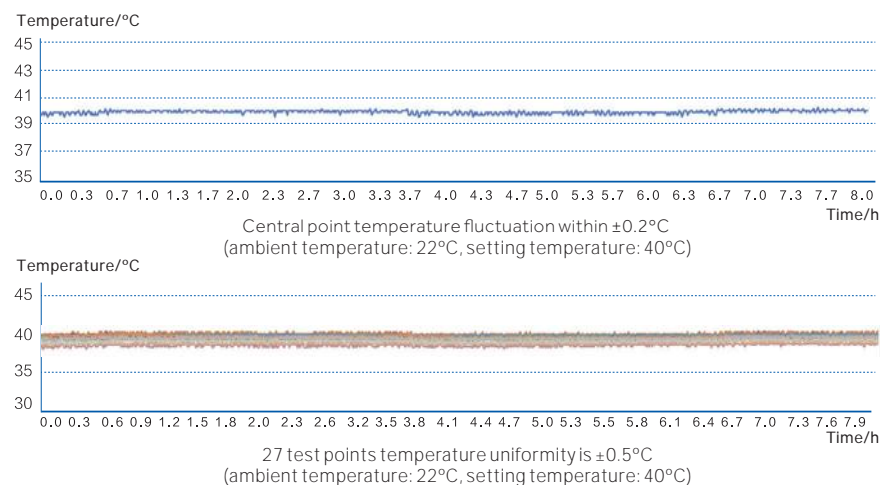

Product Parts

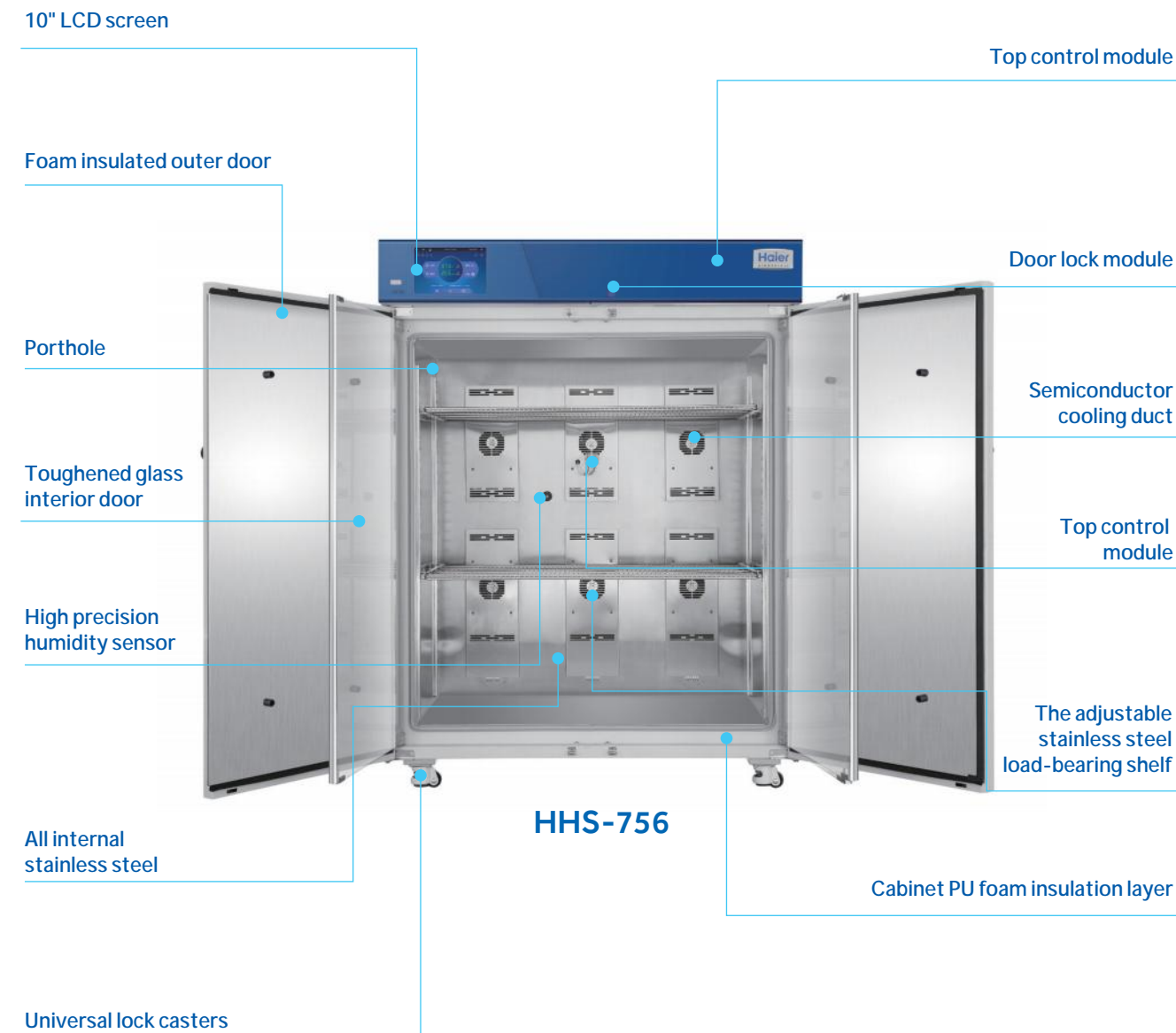



Accurate Humidity Control

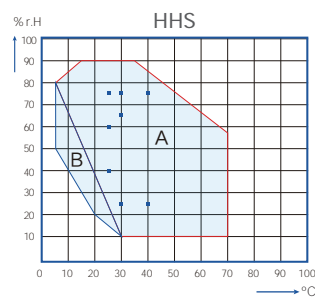

A: Stable temperature and relative humidity control range  
 B: Ambient temperature: lower than 22 °C, ambient humidity: lower than 40%  
 ■ ICH standard test points

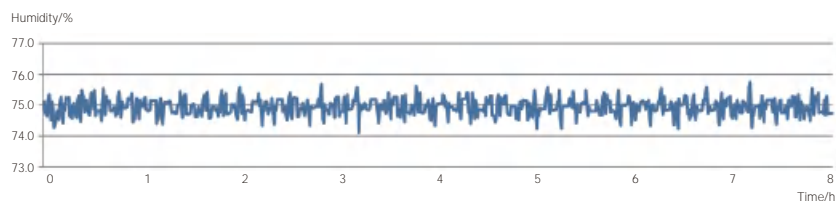

Humidity fluctuation  $\pm 1\%$   
 (setting temperature: 40°C, setting humidity: 75%  
 ambient temperature: 22°C, ambient humidity: 40%)

Internal Cabinet Environment Quick Recovery System

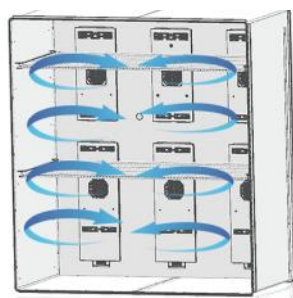

Professional air duct design, ensuring temperature and humidity uniformity

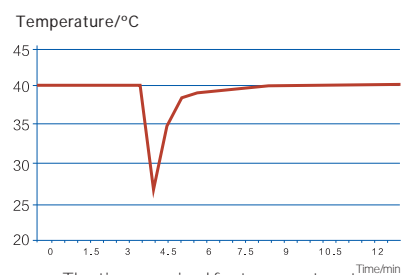

The time required for temperature to return to 40°C after 30s door opening is <4 minutes

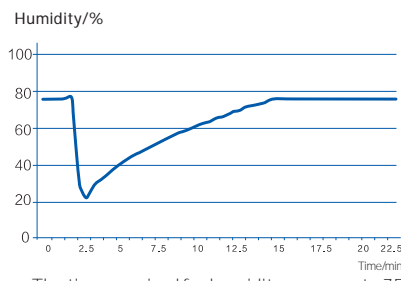

The time required for humidity recovery to 75% after opening door for 30s is <14 minutes

Intelligent Management

Convenient and intelligent management to improve working efficiency



The intelligent 10-inch touchscreen controller is easy to operate and sensitive to touch, even in rubber gloves. The PID control algorithm ensures the accuracy of temperature control

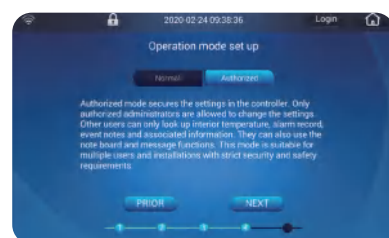

Data and multi-user authority management and permissions conforms to FDA 21 CFR Part 11



Unlimited programs with infinite humidity and temperature settings to allow users to customise to their needs

High quality manufacture and reliable operation

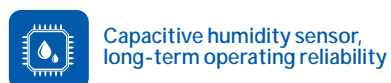

Capacitive humidity sensor, long-term operating reliability

- Interference-free humidity data collection.
- Long-term reliability without the need for calibration.
- High precision  $\pm 0.1\%$ .
- Anti-condensation design for more accurate humidity monitoring

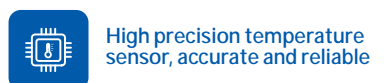

High precision temperature sensor, accurate and reliable

- Adopts PT1000 temperature sensors for accurate, stable and repeatable measurement without deviation.
- Dual sensors further improve accuracy.



Semi-conductor cooling, superior energy-saving and mute effect

- Semiconductor thermocouple consists of N-shape semiconductor and P-shape semiconductor.

Intelligent control, ensures temperature and humidity accuracy



Intelligent control PTC humidification, energy-saving and water-saving

The temperature and purity of vapour are accurately controlled by the intelligent water supply system and ceramic high-temperature heating apparatus.



Intelligent dehumidification, accurate humidity control

Semi-conductor intelligent dehumidification system accurately controls heating and cooling, matching with humidity control.

Specifications

	Model	HHS-256	HHS-506	HHS-756
Construction	Chamber Volume (L)	256L	506L	756L
	Interior Chamber	stainless steel	stainless steel	stainless steel
	Exterior Chamber	Galvanized Sheet Powder Coating	Galvanized sheet powder coating	Galvanized sheet powder coating
	Access Port	35mm Diameter	35mm Diameter	35mm Diameter
Dimensions	Net/Gross Weight	kg 175/188	225/260	280/328
	Interior Dimensions (W*D*H)	mm 650*570*700	740*570*1200	1100*570*1200
	Exterior Dimensions (W*D*H)	mm 835*905*1190	930*905*1690	1290*905*1690
	Packing Dimensions (W*D*H)	mm 1030*955*1280	1110*955*1780	1380*955*1780
Shelves	Dimension / mm (W*D)	597*531	687*531	1048*531
	Standard Qty / Max Qty	2/16	2/31	2/31
	Max Weight Per Shelf	kg 20	20	20
	Structure	Slide rail, adjustable	Slide rail, adjustable	Slide rail, adjustable
Electrical	Voltage / Frequency (V/Hz)	220-240-50/60	220-240-50/60	220-240-50/60
	Power (W)	750	1100	1760
	Day Consumption at 25°C & 40% RH (kwh)	4.6	5.4	5.6
Control	Controller	The microprocessor	The microprocessor	The microprocessor
	Display	10" smart LCD screen	10" smart LCD screen	10" smart LCD screen
The Temperature Parameter	The Set Range (°C)	5-70	5-70	5-70
	Control Precision (°C)	$\pm 0.1$	$\pm 0.1$	$\pm 0.1$
	Temperature Uniformity at 25°C	$\pm 0.2$	$\pm 0.2$	$\pm 0.2$
	Temperature Fluctuation at 25°C	$\pm 0.1$	$\pm 0.1$	$\pm 0.1$
	The Sensor	PT1000	PT1000	PT1000
	Rate of Temperature Rise (°C / min)	1	0.8	0.6
	30 Seconds Recovery Time After Door Opening at 40°C (min)	3	3.8	5
	Humidity Setting Range (% RH)	10-90	10-90	10-90
Humidity Parameter	Humidity Setting Accuracy (% RH)	0.1	0.1	0.1
	Humidity Fluctuation at 25°C & 40% RH (% RH)	$\pm 0.5$	$\pm 0.5$	$\pm 0.5$
	Daily Water Consumption (ml)	120	240	320
	Optional	Electromagnetic lock (password)	Y	Y
Standard	Printer	Y	Y	Y
	Remote Alarm Interface	Y	Y	Y
	RS485	Y	Y	Y
	Water Level Alarm	Y	Y	Y

Product appearance and specifications are subject to change without notice

# Cooled Incubator

## Scope of Application

The equipment finds extensive use across variety of settings, including the scientific research institutions, university laboratories and production departments, in the realms of environmental conservation, public health and epidemic prevention, agriculture and animal husbandry, drug testing, and aquatic industries. Its high specialization in cultivation allows it to cater to purposes such as water analysis and BOD determination, as well as the cultivation and preservation of bacteria, molds, and microorganisms and conducting plant cultivation and breeding experiments.

## Fuzzy PID Control Technology

Based on the principle of fuzzy PID control, the product achieves high-precision temperature control. The temperature fluctuation measured using the ASTM standard 12 points temperature detection method is less than 0.3°C. (Test environment temperature 22°C, set temperature 100°C)

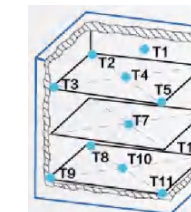

## Precise Temperature Control, Energy Efficiency, and Eco-friendly

High-quality insulation materials, and professional air duct design to ensure precise temperature control while keeping power consumption to a minimum



HSP-160

HSP-260

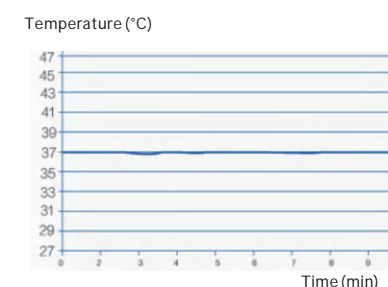

HSP-160 Temperature fluctuation±0.2°C (37°C)  
HSP-260 Temperature fluctuation±0.3°C (37°C)

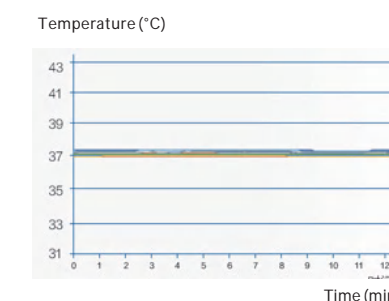

HSP-160/260 Temperature uniformity±0.5°C (37°C)

## Product Advantages

- High Thermal Insulation Performance, Energy Saving and Environmental Protection**  
Enhanced, environmentally-friendly, thermal insulation reduces energy consumption
- Wide Temperature Range**  
The temperature control ranges from 0°C to +70°C regardless of ambient conditions
- Multiple Operating Modes**  
Four operation modes for multiple temperature requirements

- Safe and Stable**  
Multiple protection systems such as overheating, overcurrent, and independent temperature limiting; overtemperature, high and low temperature and other smart alarms for safety
- Smart IoT (Optional)**  
7-inch intelligent touchscreen with optional IoT technology for real-time checking the operating status via mobile phones or PC, simple and reliable
- Data Traceability**  
Data traceable up to 15 years with base storage 8GB (64GB optional) and data exportable through USB

## Rapid Temperature Recovery After Door Opening

Fast recovery: the temperature inside the unit quickly recovers after opening the door to reduce the influence of temperature fluctuation on the sample

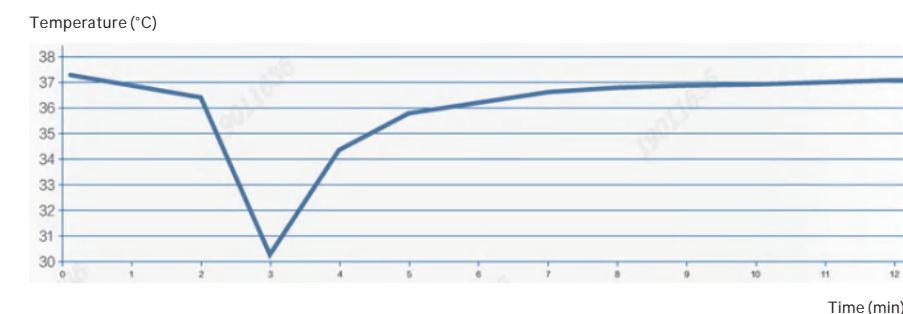

HSP-160/260

# Cooled Incubator

# Cell Culture Scene Consumables Management



Standard independent intelligent temperature safety controller to ensure experimental safety; RS485 achieves seamless IoT data connection



Ideal for experimentation during poor lighting conditions



Access port as standard, convenient for users to conduct independent testing



The inner chamber features arc-shaped corners, rendering it easily maintainable and conducive to cleanliness

## Product Parameters

Model	Capacity (L)	Power Supply (W)	Exterior Dimensions (W*D*H)(mm)	Interior Dimensions (W*D*H)(mm)	Packing Dimensions (W*D*H)(mm)	Shelves Number (Standard)
HSP-160	160	740	760*855*1375	520*520*610	850*930*1500	2
HSP-260	260	870	760*855*1765	520*520*1000	850*930*1890	2

Temperature Setting Range (°C)	Temperature Control Precision (°C)	Temperature Uniformity	Temperature Fluctuation	Recovery Time after 30 sec Door Opening (min)
0-70°C	±0.1	±0.5°C at 37°C	±0.2°C	5
0-70°C	±0.1	±0.5°C at 37°C	±0.3°C	5

## Scope of Application

The quality and correct selection of cell culture consumables is important for contamination-free growth, survival and reproduction of cells in vitro. Haier Biomedical high-quality culture consumables are the ideal choice. The raw materials meet USP V1 standards and are used to manufacture the consumables in a non-invasive production process. The whole process operates within a 100,000 GMP clean environment with cobalt-60 irradiation sterilization to ensure the uniformity and sterility of these products to guarantee safe and clean cell growth.

## Cell Culture Flask



### Product Features

- High quality polystyrene material, 100,000 clean workshop manufacturing
- TC treated and non-TC treated specifications can be used for cell adhesion culture and cell suspension culture
- Large mouth design for easy removal of cell suspension or digestive cells
- Two closure type to choose: One type is with septum cap, which has a 0.22µm membrane that allows sterile air exchange or a leak resistant seal, the other is with screw cap
- Product irradiation sterilization. RNase, DNase, Pyrogen and Endotoxin Free
- Scales and marking areas on both sides of the bottle

CAT.NO.	Description	Unit Quantity	Packing Specification
633017	25cm <sup>2</sup> , sealed cap, wall culture, TC treatment	200	10pcs/bag, 20bags/case
634018	25cm <sup>2</sup> , vented cap, wall culture, TC treatment	200	10pcs/bag, 20bags/case
633019	75cm <sup>2</sup> , sealed cap, wall culture, TC treatment	100	5pcs/bag, 20bags/case
634020	75cm <sup>2</sup> , vented cap, wall culture, TC treatment	100	5pcs/bag, 20bags/case
633021	175cm <sup>2</sup> , sealed cap, wall culture, TC treatment	40	5pcs/bag, 8bags/case
634022	175cm <sup>2</sup> , vented cap, wall culture, TC treatment	40	5pcs/bag, 8bags/case
633023	225cm <sup>2</sup> , sealed cap, wall culture, TC treatment	25	5pcs/bag, 5bags/case
634024	225cm <sup>2</sup> , vented cap, wall culture, TC treatment	25	5pcs/bag, 5bags/case
631025	25cm <sup>2</sup> , sealed cap, suspension culture, untreated	200	10pcs/bag, 20bags/case
632026	25cm <sup>2</sup> , vented cap, suspension culture, untreated	200	10pcs/bag, 20bags/case
631027	75cm <sup>2</sup> , sealed cap, suspension culture, untreated	100	5pcs/bag, 20bags/case
632028	75cm <sup>2</sup> , vented cap, suspension culture, untreated	100	5pcs/bag, 20bags/case
631029	175cm <sup>2</sup> , sealed cap, suspension culture, untreated	40	5pcs/bag, 8bags/case
632030	175cm <sup>2</sup> , vented cap, suspension culture, untreated	40	5pcs/bag, 8bags/case
631031	225cm <sup>2</sup> , sealed cap, suspension culture, untreated	25	5pcs/bag, 5bags/case
632032	225cm <sup>2</sup> , vented cap, suspension culture, untreated	25	5pcs/bag, 5bags/case



## Erlenmeyer Flask



### Product Features

- Two type of materials are available: PC/PETG with baffled bottom/flat bottom
- Two closure types: choose either screw or septim cap, which has a 0.22 $\mu$ m membrane that allows sterile air exchange or a leak resistant seal, the other is with screw cap
- Single independent vacuum packaging, easy to use, avoid cross contamination
- Product irradiation sterilization. RNase, DNase, Pyrogen and Endotoxin Free
- The scale on the outer wall of the bottle is clear and precise, and the inner wall is smooth
- Both suspension cells and adherent cells can be cultured

CAT.NO.	Description	Unit Quantity	Packing Specification
641049	125ml, PETG, sealed cap	24	1pcs/bag, 24bags/case
641050	250ml, PETG, sealed cap	12	1pcs/bag, 12bags/case
641051	500ml, PETG, sealed cap	12	1pcs/bag, 12bags/case
641052	1000ml, PETG, sealed cap	12	1pcs/bag, 12bags/case
642053	125ml, PETG, vented cap	24	1pcs/bag, 24bags/case
642054	250ml, PETG, vented cap	12	1pcs/bag, 12bags/case
642055	500ml, PETG, vented cap	12	1pcs/bag, 12bags/case
642056	1000ml, PETG, vented cap	12	1pcs/bag, 12bags/case
643057	125ml, PC, sealed cap	24	1pcs/bag, 24bags/case
643058	250ml, PC, sealed cap	12	1pcs/bag, 12bags/case
643059	500ml, PC, sealed cap	12	1pcs/bag, 12bags/case
643060	1000ml, PC, sealed cap	12	1pcs/bag, 12bags/case
644061	125ml, PC, vented cap	24	1pcs/bag, 24bags/case
644062	250ml, PC, vented cap	12	1pcs/bag, 12bags/case
644063	500ml, PC, vented cap	12	1pcs/bag, 12bags/case
644064	1000ml, PC, vented cap	12	1pcs/bag, 12bags/case
645065	125ml, PC, sealed cap	24	1pcs/bag, 24bags/case
645066	250ml, PC, sealed cap	12	1pcs/bag, 12bags/case
645067	500ml, PC, sealed cap	12	1pcs/bag, 12bags/case
645068	1000ml, PC, sealed cap	12	1pcs/bag, 12bags/case
646069	125ml, PC, vented cap	24	1pcs/bag, 24bags/case
646070	250ml, PC, vented cap	12	1pcs/bag, 12bags/case
646071	500ml, PC, vented cap	12	1pcs/bag, 12bags/case
646072	1000ml, PC, vented cap	12	1pcs/bag, 12bags/case

## Cell Culture Plate



### Product Features

- A wide range of sizes, materials and shapes to suit different experimental needs of the laboratory
- There are TC treated and non-TC treated options which is suitable for cell suspension culture and cell adhesion culture
- Sterile, no enzyme, no heat source and endotoxin, individually packed to ensure the stability of the experimental results
- High transparency polystyrene material can be used for microscope observation
- Raised edge on wells to prevent cross contamination
- The left side and the upper side have alphanumeric labels, easy to distinguish and identify, easy to record
- Suitable for most plate readers and automated equipment

CAT.NO.	Description	Unit Quantity	Packing Specification
612001	96-well, blister box/F-bottom (flat bottom), TC treatment, wall culture	100	1pcs/bag, 100bags/case
612002	48-well, blister box/F-bottom (flat bottom), TC treatment, wall culture	100	1pcs/bag, 100bags/case
612003	24-well, blister box/F-bottom (flat bottom), TC treatment, wall culture	100	1pcs/bag, 100bags/case
612004	12-well, blister box/F-bottom (flat bottom), TC treatment, wall culture	100	1pcs/bag, 100bags/case
612005	6-well, blister box/F-bottom (flat bottom), TC treatment, wall culture	100	1pcs/bag, 100bags/case
611006	96-well, blister box/F-bottom (flat bottom), untreated, suspension culture	100	1pcs/bag, 100bags/case
611007	48-well, blister box/F-bottom (flat bottom), untreated, suspension culture	100	1pcs/bag, 100bags/case
611008	24-well, blister box/F-bottom (flat bottom), untreated, suspension culture	100	1pcs/bag, 100bags/case
611009	12-well, blister box/F-bottom (flat bottom), untreated, suspension culture	100	1pcs/bag, 100bags/case
611010	6-well, blister box/F-bottom (flat bottom), untreated, suspension culture	100	1pcs/bag, 100bags/case

## Cell Culture Dish



## Product Features

- Assorted sizes, styles and surface finishes for different culture requirements
- Designed with raised edges, easy to stack and transport
- Polystyrene material, surface treatment, suitable for cell adhesion growth
- Vents designed to maintain gas exchange under sterile conditions
- Sterile, Enzyme, Pyrogen and Endotoxin Free, individual packaging, to ensure the stability of the experimental results

CAT.NO.	Description	Unit Quantity	Packing Specification
622011	6cm, plastic sealed bag/easy grip, TC treated, wall culture	500	10pcs/bag, 50bags/case
622012	10cm, plastic sealed bag/easy grip, TC treated, wall culture	300	10pcs/bag, 30bags/case
622013	15cm, plastic sealed bag/easy grip, TC treatment, wall culture	100	5pcs/bag, 20bags/case
621014	6cm, plastic sealed bag/easy grip, untreated, suspension culture	500	10pcs/bag, 50bags/case
621015	10cm, plastic sealed bag/easy grip, untreated, suspension culture	300	10pcs/bag, 30bags/case
621016	15cm, plastic sealed bag/easy grip, untreated, suspension culture	100	5pcs/bag, 20bags/case

## Pipette Series

### Serological Pipette

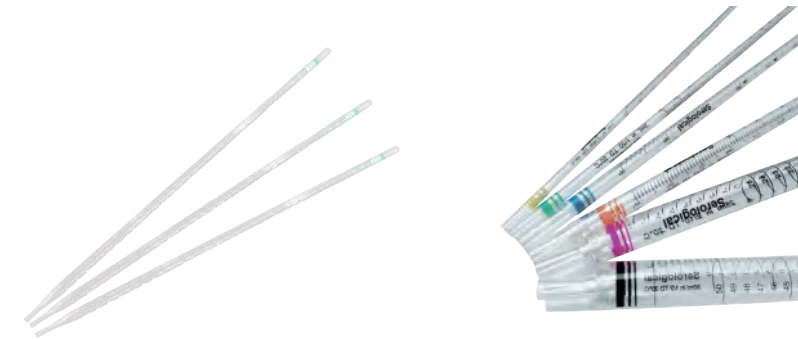

## Product Features

- Multiple volume sizes available, different color rings on the tube head for easy identification of different models
- Bi-directional scale design for easy reading of pipette volume, negative scale increases pipette capacity for larger volumes
- Clear and accurate scale with a precision of  $\pm 2\%$  of total volume
- Filter cartridge prevents samples, aerosols and water vapor from entering the pipette to avoid cross-contamination
- Adaptable to a wide range of pipettes on the market with rubber adapters
- Multiple packaging options, easy-tear paper-plastic single packs as well as large packs for easy batch use and reduced packaging waste
- Irradiated, meet SAL  $10^{-6}$ , DNase/RNase free, no pyrogenic endotoxin

CAT.NO.	Description	Unit Quantity	Packing Specification
692109	1ml (yellow) disposable serum pipette, sterile	1000	50pcs/bag, 20bags/box
692110	2ml (green) disposable serum pipettes, sterile	1000	50pcs/bag, 20bags/box
692111	5ml (blue) disposable serum pipettes, sterile	500	50pcs/bag, 10bags/case
692112	10ml (orange) disposable serum pipettes, sterile	500	50pcs/bag, 10bags/case
692113	25ml (red) disposable serum pipettes, sterile	250	25pcs/bag, 10bags/case
692114	50ml (violet) disposable serum pipettes, sterile	200	25pcs/bag, 8bags/case
692115	100ml (black) disposable serum pipettes, sterile	120	20pcs/bag, 6bags/case

## Pasteur Pipette

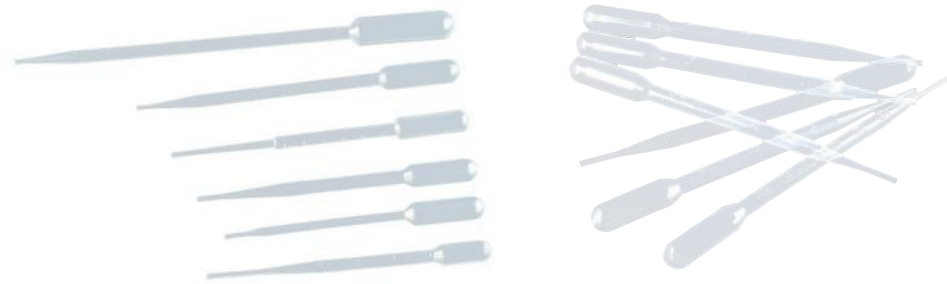

## Product Features

- Good fluidity of the tube wall, easy to control the pipetting volume during operation
- High transparency, clear scale, easy to observe the pipetting process in real time
- Made of high quality material, it can be used for pipetting liquids in all kinds of containers
- Individual packages, easy to use, well sealed, reproducible pipetting
- Each package is individually labeled with a lot number for quality tracking and traceability
- Enzymatic, Pyrogenic, Endotoxic, Cytotoxic and Hemolytic Free
- EO sterilized to ensure contamination-free experiments

CAT.NO.	Description	Unit Quantity	Packing Specification
603001	Total volume 1.5ml. Each 0.1ml scale to 0.3ml, length 116mm, about 23 drops/ml, E.O. sterile, LDPE material	1000	Plastic pack, 100pcs/ box, 1,000pcs/case
603002	Total volume 3ml. Every 1/4ml scale to 1ml, length 140mm, E.O. sterile, LDPE material	1000	Plastic pack, 100pcs/ box, 1,000pcs/case
603003	Total volume 5ml. Every 1/4 ml scale to 1 ml, length 145 mm, E.O. sterile, LDPE material	1000	Plastic pack, 100pcs/ box, 1,000pcs/case
603004	Total volume 5ml. Every 1/4ml scale to 1ml, length 150mm, E.O. sterile, LDPE material	1000	Plastic pack, 100pcs/ box, 1,000pcs/case
603005	Total volume 5ml. Every 1/2ml scale to 2ml, length 155mm, E.O. sterile, LDPE material	1000	Plastic pack, 100pcs/ box, 1,000pcs/case
603006	Total volume 7ml. Every 1/2ml scale to 3ml, length 155mm, E.O. sterile, LDPE material	1000	Plastic pack, 100pcs/ box, 1,000pcs/case
603007	Total volume 7.5ml. Every 1/2ml scale to 3ml, length 148mm, approx. 23 drops/ml, E.O. sterile, LDPE	1000	Plastic pack, 100pcs/ box, 1,000pcs/case

## Centrifuge Tube Series

## Microcentrifuge Tubes



## Product Features

- Made of USP Class VI, medical-grade polypropylene (PP), free from release agent, plasticizer, bacteriostatic agent, and heavy metals
- High-clarity tube for convenient sample observation
- The unique cap design with flat surface for writing, delivers enhanced sealing and enables single-handed operation
- Temperature range: -80°C-120°C



Ultra-high clarity makes samples clearly visible

Universal design suitable for all major brands



Frosted writing area



Snap-on safety cap to ensure safe centrifugation to maximize operational safety during centrifugation

CAT.NO.	Description	Unit Quantity	Packing Specification
311001	0.6ml microcentrifuge tube, non-sterile	10000	1000pcs/box, 10box/ctn
311002	1.5ml microcentrifuge tube, non-sterile	5000	500/box, 10boxes/case
311004	2.0ml microcentrifuge tube, non-sterile	5000	500/box, 10boxes/case



# Sterilization



# Drying Oven

## Scope of Application

Typically used for drying and sterilization of laboratory consumables, instruments and samples; as well as heating and curing, drying and dehydration, heat removal, moisture content determination of materials and samples in the fields of medicine, chemical industry, agricultural products. Other uses include, high temperature heat resistance tests and thermal aging tests of rubber, plastic products and electrical insulation materials. The solution is widely used in medical, enterprise, universities, scientific research institutions, environmental monitoring centers, pharmaceutical, food and drug quality monitoring centers and other related industries.



Laboratory consumables



Instruments



Thermal aging test



HFS-160



HZS-60

## Product Advantages

- High thermal insulation performance, energy saving and environmental protection**  
 Environmentally-friendly aluminium foil cotton insulation provides excellent insulation performance to reduce energy consumption and lower running costs.
- Personalized interface, easy to transfer data**  
 Equipped with USB and RS485 interfaces to better meet the different needs of users for transfer data.
- Precise high temperature control**  
 Superior preheating technology with an innovative air duct structure.
- Safe and stable**  
 Multiple safety protection features.

- Multiple safety protections**  
 Overheat protection (OPT), over current protection (FU), sensor error detection, independent temperature limit, compliance with DIN 12880 requirements and EU 3.1 safety level. Sound, light and remote alarms guarantee experiment safety.
- Scalable bulk data storage**  
 The touch-screen can be increased to 64GB with capacity to store 15 years' data. The data can be exported using a USB flash drive.
- Smart interface**  
 7-inch intelligent touchscreen with optional IoT technology for real-time remote monitoring via an app.
- Operation mode**  
 Four operation modes for multiple temperature requirements.

## PID Control Technology

HFS-160  
Forced convection

HZS-60  
Natural convection

ASTM standard,  
12 points testing

Based on PID control principle, manufactured with U-shaped 3-sided heating to achieve superior temperature control and uniformity control.

## Precise Temperature Control, Energy-efficient and Quiet

High performance 3-sided heating and professional air duct design, high-quality fan components and insulation materials ensures precise temperature control while keeping power consumption to minimum.

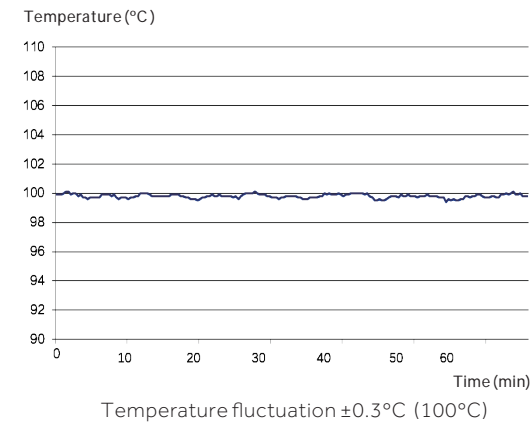

HFS-160

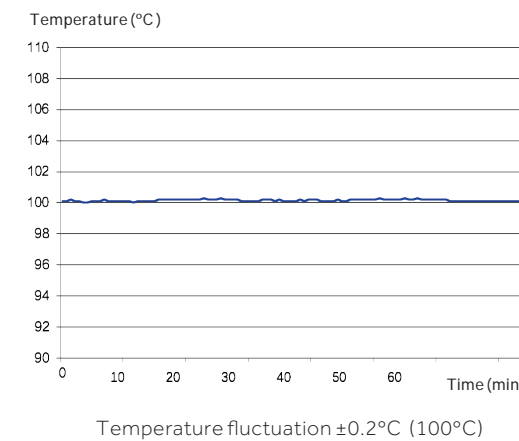
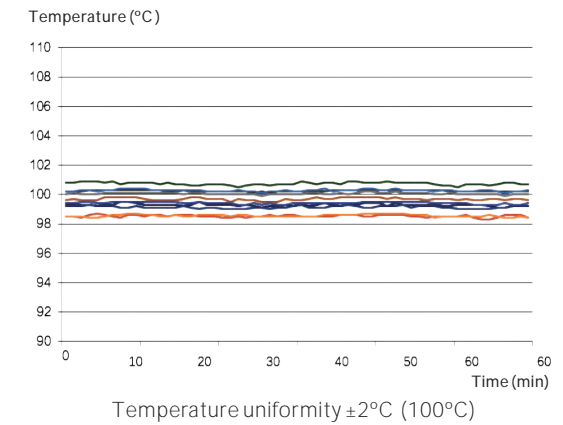

HZS-60

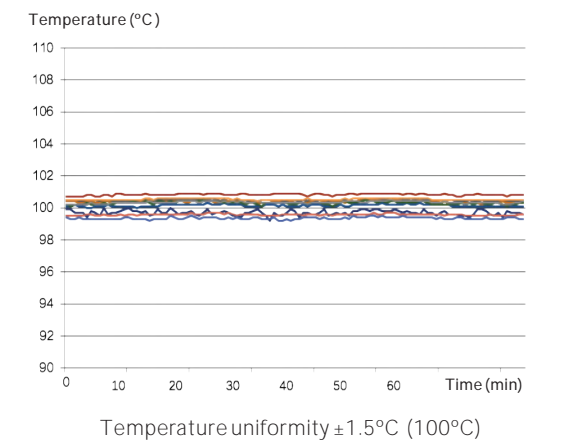



Rapid Recovery After Door Open

The temperature inside the unit quickly recovers after opening the door without overshoot.

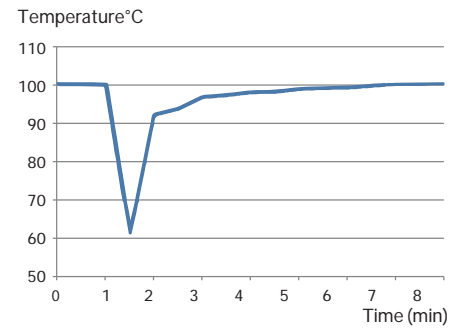

Temperature recovery curve to 100°C after opening the door for 30s

HFS-160

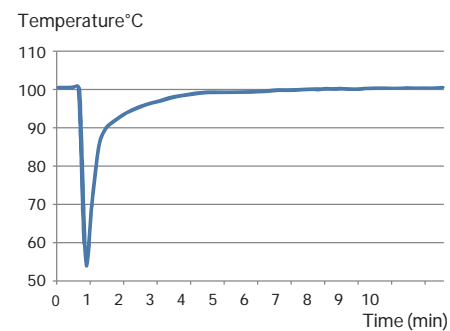
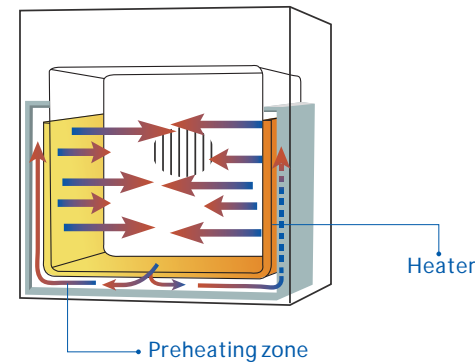

Temperature recovery curve to 100°C after opening the door for 30s

HZS-60

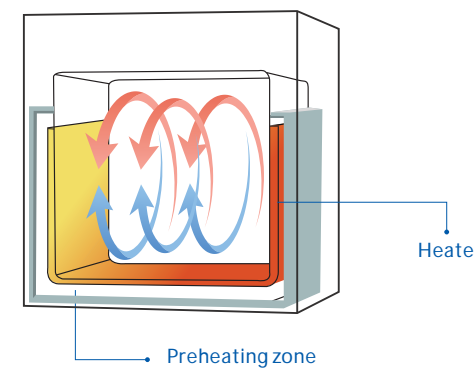

Convenient and Intelligent Management at a Glance

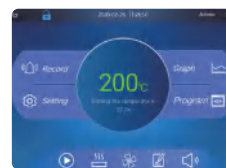

7-inch touchscreen, easy to operate and sensitive, it can respond quickly even when wearing rubber gloves.



Real-time display of temperature data, one-touch to review previous data.

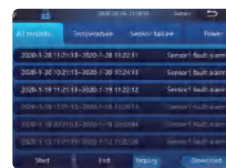

Records abnormal information in real time, to eliminate hidden errors.



Multiple operating modes.



The program can be edited and set at any number of segments to meet the needs of various detection tests.

Optional IoT Technology for Real-time Remote Monitoring



Through the mobile app, the status of the dry chamber can be checked in real time, and information such as temperature abnormal alarm, sensor error alarm and door ajar can be controlled with one button, which provides more security for the experiment process.

Pictures in Details



Ergonomic self-locking handle, firm and durable, easy to use.



Large arc angle 304 mirror stainless steel inner liner, easy to clean.



Standard independent intelligent temperature safety controller to ensure experimental safety.

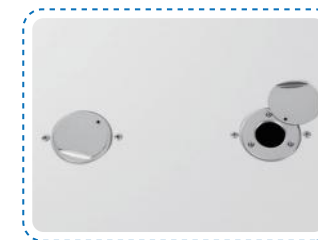

It is equipped with portholes to facilitate external equipment monitoring to record the experimental process.

Product Parameters

Model	Product Series	Capacity (L)	Power (W)	Exterior Dimensions (W*D*H)(mm)	Interior Dimensions (W*D*H)(mm)	Packing Dimensions (W*D*H)(mm)	Shelf Dimensions (mm)	Shelves (standard/maximum)	Shelves Spacing (mm)
HZS-60	Natural convection	60	900	572*719*792	370*385*420	710*810*945	340*345	2/9	30
HFS-160	Forced convection	160	2500	752*809*973	550*492*600	895*900*1025	520*445	2/15	30

Temperature Setting Range (°C)	Temperature Uniformity	Temperature Fluctuation	Temperature Control Precision (°C)	Heating Rate (ambient temperature 22°C)	Recovery Time after Opening the Door for 30s
RT+10~200	±1.5°C at 100°C ±2.5°C at 150°C	±0.2°C at 100°C ±0.3°C at 150°C	±0.1	40min to 100°C 50min to 150°C	9min to 100°C 20min to 150°C
RT+10~200	±2°C at 100°C ±3°C at 150°C	±0.3°C at 100°C ±0.4°C at 150°C	±0.1	20min to 100°C 30min to 150°C	4min to 100°C 5min to 150°C

Product appearance and specifications are subject to change without notice



# Drying Oven

## Scope of Application

Typically used for drying and sterilization of laboratory consumables, instruments and samples as well as heating and curing, drying and dehydration, heat removal, moisture content determination of materials and samples. The solution is widely used in medical, enterprise, universities, scientific research institutions, environmental monitoring centers, pharmaceutical, food and drug quality monitoring centers and other related industries.



## Product Advantages

- Wide Temperature Range**  
Operating from 10°C above ambient temperature up to 250°C
- PID Control Technology**  
Ensures superior temperature and uniformity control
- Smart IoT Module (optional)**  
Through the mobile app, the status of the drying oven can be checked in real time
- 4-inch Display Screen**  
Intuitive user interface and easy-to-read display
- Multiple Safety Protections**  
Multiple protection systems such as overheating, overcurrent, and independent temperature limiting; overtemperature, high and low temperature and other alarms for safety
- Innovative Air Duct Structure**  
Improved level of temperature uniformity inside the chamber as good as  $\pm 2^\circ\text{C}$  at 100°C (HFS-60E)

## Precise Temperature Control

Based on the principle of fuzzy PID control, the product achieves high-precision temperature control. The temperature fluctuation measured using the ASTM standard 12 points temperature detection method is less than 0.3°C. (Test environment temperature 22°C, set temperature 100°C)

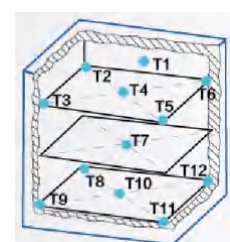
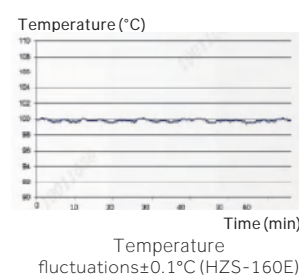
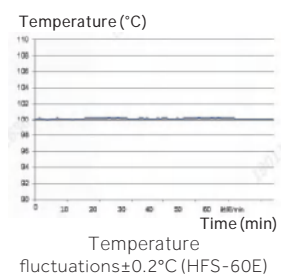

## Rapid Temperature Recovery After Door Opening

The U-shaped 3-sided heating system provides a continuous source of power for quick temperature recovery when opening the door, and high-performance insulation materials reduces heat loss

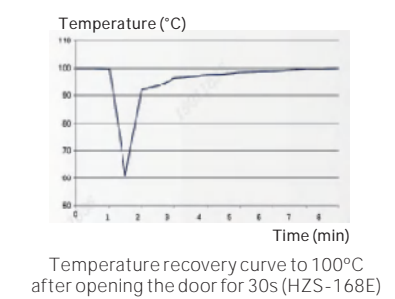
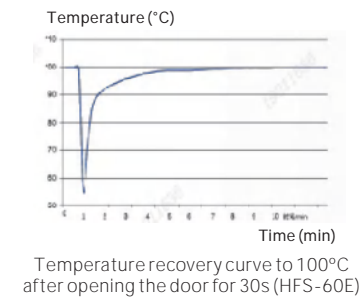

## Air Jacket Heating Without Overshoot of Temperature

By adopting pre-heated air jacket heating (HFS-60E), the temperature remains stable and recovers quickly without any overshoot, enabling precise temperature control across the entire range of temperature segments, and enhancing the temperature uniformity of the chamber

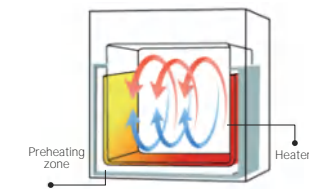

- 4-inch LED screen with simple operation and clear display
- Standard independent intelligent temperature safety controller to ensure experimental safety
- New ergonomic handle design
- Multiple shelves of adjustable height
- Adjustable feet for easy positioning and leveling
- Smooth inner chamber with easy to clean rounded corners

## Product Parameters

Model	Capacity (L)	Temperature Setting Range (°C)	Temperature Control Precision (°C)	Temperature Uniformity	Temperature Fluctuation	Heating Rate (ambient temperature 22°C)
HFS-60E	60	RT+10-250	±0.1	±2°C at 100°C ±3°C at 150°C	±0.3°C at 100°C ±0.4°C at 150°C	20min to 100°C 30min to 150°C
HZS-160E	160	RT+10-250	±0.1	±1.5°C at 100°C ±2.5°C at 150°C	±0.2°C at 100°C ±0.3°C at 150°C	9min to 100°C 20min to 150°C

# Vertical Autoclave

357/358

## Scope of Application

This upright automatic rapid sterilization unit uses high temperature saturated steam as the sterilization medium. Applicable to testing laboratories, laboratories, operating rooms, supply rooms, higher education, animal husbandry, disease control centers and other medical and biomedical research units, achieve rapid sterilization of instruments, dressings, rubber, liquids, glassware, bacteria and cell culture medium, wastes, etc.



HRLM-80

## Product Advantages



### Automatic Program Control

One-click program control to automate the whole process-water injection, heat, exhaust, sterilization, pressure relief, drainage and drying.



### Automatic Drying Function (Auxiliary Drying)

The drying time can be set after the sterilization is completed.



### Warm-up Control and Timing Start

The preheating control function supports the sterilizer heating process, which shortens the heating time of the sterilizer and improves the efficiency of the process; equipped with timed starter function, the sterilization program can be set to a predetermined time and users can organise the processing time to suit.



### Multiple Exhaust Methods

A variety of exhaust methods such as regular temperature setting exhaust, dynamic exhaust and full-process air escape, completely eliminates the cold air in the sterilizer and improves steam saturation, ensuring effective sterilization.



### One-click Start of Stored Procedures

Equipped with quick programs for instruments, dressings, rubber and liquids, one-button start for easy operation.



### Two Pressure Relief Methods

Two pressure relief methods are available: fast pressure relief and slow pressure relief. The slow pressure relief method for liquid sterilization can prevent liquid overflow caused by rapid buildup of pressure.

## Safety Mechanisms

### Automatic overpressure pressure relief:

When the set pressure is exceeded, the safety valve opens automatically to release the pressure.

### Anti-drying protection:

When the water level is too low, the power will automatically cut off, the operation is stopped, and an alarm is automatically generated.

### Sensor disconnection detection:

Monitors the status of the sensor in real time to ensure that the sensor is working properly to prevent excessive temperature caused by abnormal sensors.

### Standard over-current, over-voltage protection and leakage protection.

### Automatic over-temperature protection:

When the set temperature is exceeded, the system cuts off the power supply and alarms automatically generated.

### Door safety protection:

Real-time detection of door status, sterilization procedures cannot be started if the door is not tightly closed and there is a reminder to open the door; the sterilization can only start when the door is normally closed. However, when there is pressure in the sterilizer, the sealing door cannot be opened to prevent damage caused by steam leakage.

### Full protection thermal insulated door cover:

The door cover is made of high-performance thermal insulation material which completely covers the metal door, which prevents the operator from being burned.

## Air Switch Solution

### More secure and reliable connection

Over-current, overvoltage, current leakage protection, in case of tripping operation, the other equipment connected to the air switch will not be affected.



Air switch



Nylon connector  
Fix, waterproof

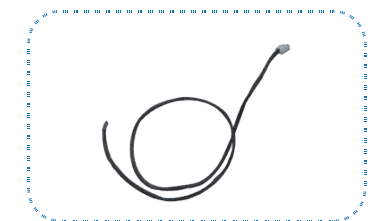

External cable  
2m

Shell material  
ABSbox/PC Transparent cover

Waterpro of level  
IP65

Features  
Waterproof, dustproof, corrosion-resistant, high-strength insulation

Model	HT Switch Box	Dimension (mm)
HT-5	Length	120
	Width	160
	Height	95

### Standard configuration

Nylon connector + external cable (2m) + air switch (residual current operated circuit-breaker + protection box)

## Specifications

Model	Volume (L)	Net Weight (Kg)	Power Supply (V/Hz)	Power (W)	Exterior Dimension (W*D*H mm)	Interior Dimension (mm)	Design Pressure (Mpa)	Design Temperature (°C)	Rated Working Pressure (Mpa)	Pressure Display Range (Mpa)
HRLM-80	80	105	220-240 50/60	4200	546*750*1085	φ 386*695	0.28	150	0.22	-0.1-0.3

Sterilization Temperature Range	Temperature Control Precision (°C)	Dynamic Pulse Exhaust Times	Dynamic Pulse Exhaust Temperature	Solution Temperature (°C)	Holding Temperature (°C)	Sterilization Time Range	Cabinet and Door Material	Accessories	
105-136°C	±0.1	0-99 (Settable)	110-136°C	40-100 (Settable)	40-100 (Settable)	1-999 mins	SUS304 Stainless Steel	2 Stainless Steel Sterilized Baskets	Optional Printer

\*Haier Biomedical reserves the right to change products and specifications without prior notice.

# Vertical Autoclave

359/360

## Scope of Application

Suitable for a wide range of applications used within laboratories, operating rooms, disease control centers and other biomedical/medical research areas. Intended for the sterilization of a wide range of liquids and solids such as glassware, rubber and other laboratory items.



HRLM-60A/80A

## Product Advantages

**Dual cooling system**  
High density finned condenser and high air volume cooling fan are connected in series to provide two-stage cooling and external steam exhaust.

**Ten-model exhaust control technology**  
Adopting PID control technology to achieve controllable cooling time and non boiling liquid, selecting a suitable exhaust mode scheme can save time and improve efficiency.

**Anti-dry burning protection**  
The use of floating balls and manual reset temperature controllers ensures sterilization safety and can extend the service life of the equipment.

**Multiple options**  
Optional IoT module, fast cooling module, 316 stainless steel sterilization chamber, stainless steel bucket, matrix printer, high-efficiency sterilization filter, and item temperature sensor.

**Door pressure mechanical interlock**  
When there is pressure in the sterilization chamber, the mechanical interlocking device starts and the sealing door remains tightly closed.

## Experience Upgrade

### Drainage without exhaust



Dual cooling system and ten-model exhaust control technology ensure zero steam discharge during the entire process of program equipment operation, this is to ensure environmental cleanliness, and avoid aerosol generation and biological laboratory hazards.

## Ergonomic details



Ergonomic and anti-scald door handle

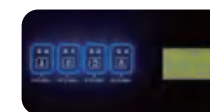

4-inch LCD display screen and touch buttons



Mechanical safety valve



Vaporous protection plate of door cover

## One-click start of sterilization

Standard dressings, instruments, rubber, liquid one click start program.

## Air Switch Solution

### More secure and reliable connection

Over-current, overvoltage, current leakage protection, in case of tripping operation, the other equipment connected to the air switch will not be affected.



Air switch



Nylon connector  
Fix, waterproof

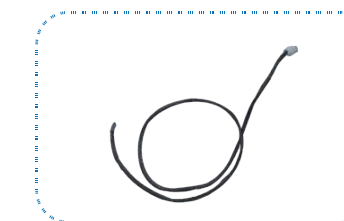

External cable  
2m

**Shell material**  
ABSbox/PCtransparent cover

**Waterpro of level**  
IP65

**Features**  
Waterproof, dustproof, corrosion-resistant, high-strength insulation

Model	HT Switch Box	Dimension (mm)
HT-5	Length	120
	Width	160
	Height	95

## Standard configuration

Nylon connector + external cable (2m) + air switch (residual current operated circuit-breaker + protection box)

## Specifications

Model	Power Supply (V/Hz)	Volume (L)	Power (W)	Exterior Dimension (W*D*H)(mm)	Sterilization Temperature Range	Temperature Control Precision
HRLM-60A	220-240-50/60	60	3400	581*706*903	105-136°C	±0.1°C
HRLM-80A	220-240-50/60	80	3400	581*706*1020	105-136°C	±0.1°C

Design Pressure (Mpa)	Rated Working Pressure (Mpa)	Dynamic Pulse Exhaust Times	Heating Mode	Exhaust Mode
0.28	0.22	0-99 (Settable)	Ten-model	Ten-model
0.28	0.22	0-99 (Settable)	Ten-model	Ten-model

\*Haier Biomedical reserves the right to change products and specifications without prior notice.



## Scope of Application

For medical, healthcare, scientific research and other related industries to disinfect medical devices, laboratory appliances and materials that may come into contact with blood or body fluids. Mainly used in ophthalmology, stomatology, beauty clinics, pet clinics, community service stations and other associated scenarios.



HRTM-18/HRTM-23

## Ergonomic Design

### ● Programmable Mode

The program can be edited to meet different requirements.

### ● Novel Structure

Easy-to-clean, smooth and curved inner liner manufactured from one piece of 304 stainless steel.

### ● High Efficiency Vacuum Pump

The sterilization cycle is greatly shortened, and the sterilization and drying effects are improved.

### ● A New Steam Generator is Adopted

An efficient steam generator with high heat exchange efficiency and large gas output is adopted to meet the requirements of rapid temperature rise and sterilization of the sterilized equipment.

### ● Large Capacity Water Storage Tank

Open water storage tank, easy to clean. High water level display, low water level alarm, when the low water level alarm starts to alarm.

## Product Advantages



### Triple Protection of Temperature and Pressure Monitoring, Electronic Lock and Mechanical Safety Device

When the set pressure is exceeded, the safety valve opens automatically to release the pressure



### High Degree of Safety by Extensive Safety Devices

Automatic over-temperature protection, over-current, over-voltage protection and leakage protection, anti-drying protection, sensor disconnection detection, door safety protection, and full protection thermal insulated door cover



### Optimized Total Operating Time

A vacuum forced cooling system and under pressure blast drying system ensures rapid sterilization, greatly shortening the sterilization time and improve the drying effect



### LCD Display and Touch Screen Control are Adopted

4-inch TFT full-color LCD screen makes graphics and figures clear at a glance, easy to use



### Optional-Intelligent IoT Module to Enable the Mobile APP to Monitor the Running State of the Autoclave



### New Technology

Adopts a new generation steam generator to increase the saturation of saturated steam that sterilizes thoroughly

## Specifications

Model	HRTM-18	HRTM-23
Design Pressure (Mpa)	0.28	0.28
Design Temperature (°C)	150	150
Rated Working Pressure (Mpa)	0.22	0.22
Sterilization Temperature Range (°C)	105-138	105-138
Temperature Control Precision (°C)	±0.1	±0.1
Dynamic Pulse Exhaust Times	0-9	0-9
Sterilization Time Range (min)	0-999	0-999
Power Supply (V/Hz)	220-240-50/60	220-240-50/60
Power (W)	2800	3200
Capacity (L)	18	23
Weight (KG)	47	53
Interior Dimension (mm)	φ 247*350	φ 247*450
Exterior Dimension (W*D*H) (mm)	490*600*455	490*690*455
Cabinet and Door Material	SUS304	SUS304

\*Haier Biomedical reserves the right to change products and specifications without prior notice.

## Scope of Application

The product is applicable to biosafety cabinets, pass-through boxes, incubators, airlocks and channels, flow cytometer, PIVAS, microbiological incubators, robot arm work bins, desktop sealed operating bins, mobile biosafety vehicles, ambulances, first aid inflatable tents and military mobile experimental isolators as key examples



HGYX-Y100

## Ergonomic Design

- With small volume and total weight of 12kg, it is easy to carry and store
- It takes less than 2 hours for total disinfection, saving time
- Pre-warning function of the program: sound and light alarm before the disinfection program starts
- One-button disinfection, no other operation is needed during the disinfection

## Product Advantages



### Safety

Safe, non-toxic disinfection method



### Portable

Compact size, light weight and convenient to handle and carry



### High Penetrability

Small diameter particles of strong penetrability for HEPA filter



### High Disinfection Level

Higher disinfection level with less consumption of hydrogen peroxide



### Easy to Clean

Electrostatic epoxy powder coated, which is corrosion resistant and easy to clean



### High-efficiency

Disinfection time is less than 1 hour  
Reduced equipment downtime, users only need to ventilate for 30-60 minutes after disinfection before the equipment can be put back into operation



### Quick Connection

Standard DN quick connector, which can be quickly connected to the equipment

## Product Parts



## Scope of Application

The product is applicable to high-risk areas in medical institutions, biosafety laboratories, intensive care units, operating rooms, laboratories, infection wards, general wards, biopharmaceutical enterprises, public areas, and places with disinfection requirements.



HGYX-Y500

## Product Advantages



### Larger Disinfection Space

The disinfection coverage is up to 300m<sup>3</sup>



### Eco-Friendly 7%~7.5% Hydrogen Peroxide Sterilizing

Safe, non-toxic disinfection method



### High Disinfection Level

It provides a 6-log sporicidal kill on exposed surfaces



### Ergonomic Design

Compact design with wheels, easy to move and store as required



### High-efficiency

It takes less than 3 hours for total disinfection, saving time

## Ergonomic Design

### PIR Sensor Technology

With the PIR sensor, equipment does not work if any persons are detected.

### Multiple Alarms

Audible and visual alarm functions: high/low temperature alarm, high and low humidity alarm, and residual liquid volume alarm.

### Energy Saving and Environmental Protection

Using a hydrogen peroxide solution, it decomposes into water and oxygen after disinfection.

### Unique Patented Nozzle

The spray system has unique patented sprinkler head and the spray particle size average is  $\leq 3\mu\text{m}$ .

### Real Time Detection of Temperature and Humidity

Real time monitoring and recording of data during operation.

### USB Interface

Capable of storing more than 10 years of data.

## Product Parts

Real-time Monitoring Temperature and Humidity



Touch Screen



PIR Sensor



USB Interface

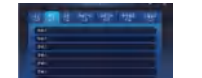

Universal Silent Caster



Unique Patented Nozzle



## Specifications

Model	Power Supply (V)	Power (W)	Vaporization Rate (ml/min)	Maximum Vaporization (ml)	Disinfection Time	Disinfection Efficiency	Net/Gross Weight (kg)	Exterior Dimensions (W*D*H)(mm)	Packing Dimensions (W*D*H)(mm)
HGYX-Y100	220	700	1-10	500	<2h	>99.9%	12/15	300*300*350	410*405*495
HGYX-Y500	220	1100	15-25	5000	<4h	>99.9%	30/35	350*350*950	590*430*1100

\*Haier Biomedical reserves the right to change products and specifications without prior notice



# Centrifuges



# Floor-Standing Low-Speed Refrigerated Centrifuge

369/370

## Scope of Application

Specifically designed for use in blood banks and transfusion facilities. Widely applied in biopharmaceuticals, cell therapy, biological culture, vaccine production, universities and other related fields.



LX-75L2400R

## Product Advantages



### Ergonomic Angled Touch Screen

The 10-inch 45° glove-friendly touchscreen, easy, comfortable and practical for users of all heights



### Precise Speed Control

High-precision speed control technology to ensure the accuracy of experimental data



### High-volume Processing

Able to handle 14.4L samples or 12 bags of 500ml quadruple blood bags per run. For use with 250ml, 500ml, 1000, 2400ml centrifuges tubes/bottles. (Equipped with 2 types of rotors and 3 kinds of adapters as standard)



### Precise Temperature Control and Ultra-fast Refrigeration

- The fuzzy PID control with seamless evaporator to achieve rapid temperature control
- Precooling from 22°C to 4°C, takes only 15 minutes
- Unique temperature control technology enables fast temperature adjustments of the centrifuge chamber and accessories to a defined temperature, which is particularly important when working with pre-chilled blood pouches



### Quiet Operation

It ensures a pleasantly quiet working environment with a noise level of 65dB and smooth running even at maximum speed (7500)



### Multi-level User Management

Effectively protects personal data, centrifugal programs and operation parameters can be stored separately for organised data management



### Convenient Operation

- Storage for numerous protocols
- One button automatic front-to-back door opening and closing



### Safe Operation

- Engineered and manufactured in accordance with all relevant safety and production standards
- Anti vibration lid lock/active balance detection/over temperature/speed protection/fully covered steel plate protective sleeve and 12mm steel shell
- Rotors are made of high-performance materials for outstanding lifetime

## Product Parts



Easy to clean, corrosion-resistant 316 stainless steel chamber

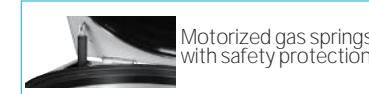

Motorized gas springs with safety protection



Intelligent energy-saving mode: It features impressive energy efficiency

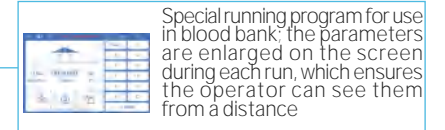

Special running program for use in blood bank; the parameters are enlarged on the screen during each run, which ensures the operator can see them from a distance

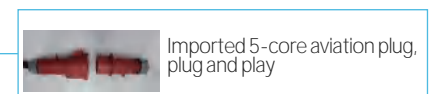

Imported 5-core aviation plug, plug and play



Universal casters for easy movement. 120mm adjustable foot for more stable installation

## Specifications

Model	Max Speed (r/min)	Max RCF (xg)	Max Capacity (ml)	Sound Level (dB(A))	Temperature Setting Range (°C)	Temperature Accuracy (°C)	Speed Accuracy (rpm)
LX-75L2400R	7500	13376	6*2400	≤65	-20-40	±2	±10

Time Setting Range	Power (W)	Power Supply (V/Hz)	External Dimensions (W*D*H)(mm)	Net Weight (kg)	Height of Lid Open (mm)	Packing Dimension (W*D*H)(mm)	Gross Weight (kg)
1s-99h 59min59s	7000	AC380, 50/60	900*1050*1020	670	1780	1100*1290*1275	750

## Rotor Configuration List

No.	Rotor Description	Max Capacity (ml)	Max RCF (xg)	Max Speed (rpm)	Singe Tube Capacity (ml)	Tube Type	Picture
1	Fixed Angle Rotor	6*1000	13376	7500	1000	Flat	
	Adaptor	6*500	6 pcs/set		500	Conical	
	Adaptor	6*250	6 pcs/set		250	Conical	
	Centrifuge Bottle	6*1000	6 pcs/set		1000	Flat	
2	Swing-out Rotor	6*2400	5331	4000	2400	/	
	Bucket	6*2400	5331	4000	2400	Flat	
	Centrifuge Bottle	6*2400	6 pcs/set		2400	Flat	
	Adaptor	6*2*500	6 pcs/set		500	Blood Bag	

\*Haier Biomedical reserves the right to change products and specifications without prior notice.

# Benchtop High-Speed Refrigerated Centrifuge

## Scope of Application

For the separation and purification of samples of cells, macromolecular proteins, blood, body fluids, DNA/RNA, plasmids, bacteria and viruses.



LX-155T500R

## Product Advantages

- Real-time Monitoring and Alarms**  
 The sensor automatically monitors vibration in real time, and will stop and alarm when excess vibration is detected
- Rotor Balance Detection**  
 Dynamic monitoring of the centrifugal process means that the centrifuge will automatically stop in the event of a balance error
- Precise Ultra-fast Refrigeration**  
 The fuzzy PID control with seamless evaporator ensures precise temperature control and high-efficiency heat transfer
- Long Service Life of Motor**  
 Dynamic sealing technology effectively prolongs the service life of motor
- Ergonomic Angled Touch Screen**  
 The 7-inch touchscreen is angled at 45° for comfortable and practical for users of all heights
- RFID Rotor Recognition**  
 The Auto-ID rotor is instantly identified by the centrifuge upon installation; this ensures the rotor operates within safe limits
- Smart and Intelligent Control**  
 Large smart screen controller provides an interactive interface which is easy to operate even in gloves
- Precise Speed Control**  
 High-precision speed control technology ensures process integrity

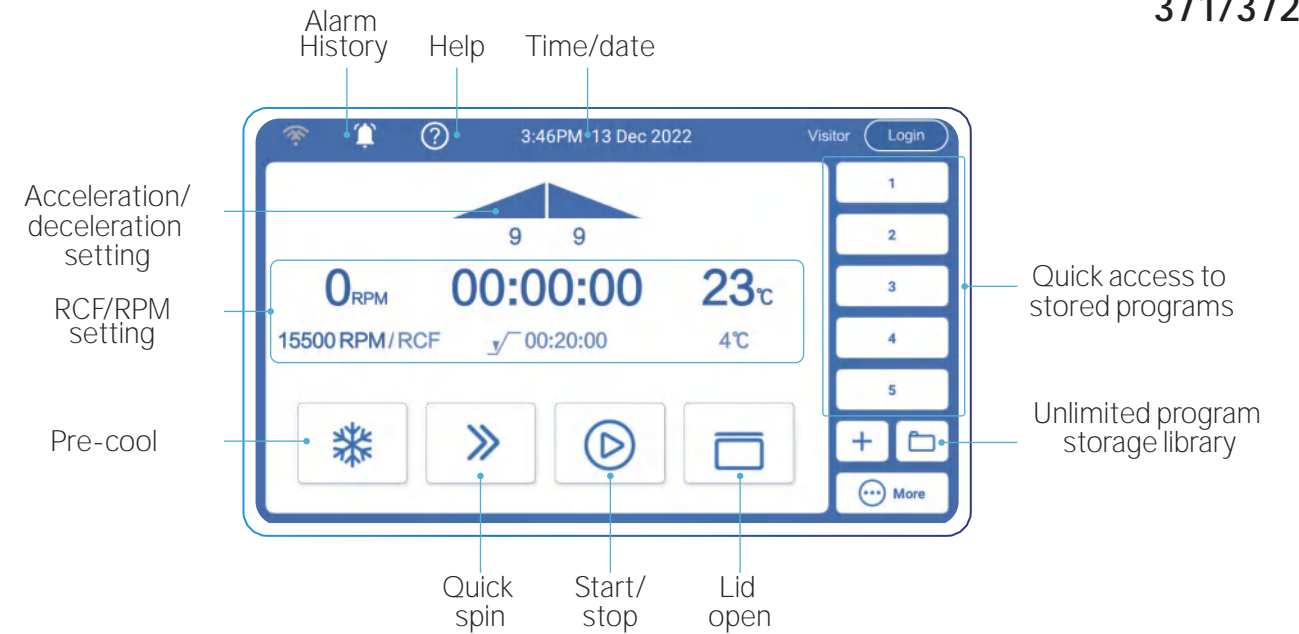

## Product Parts

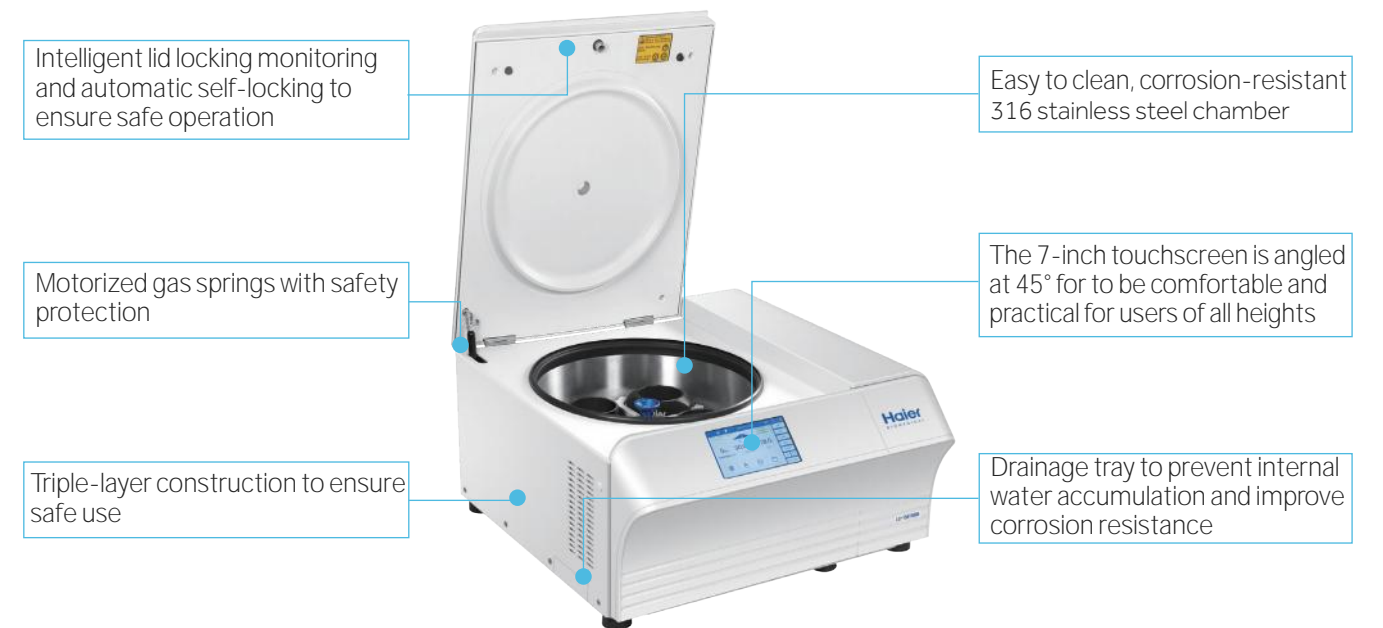

## Specifications

Model	Speed Range (r/min)	Max RCF (xg)	Max Capacity (ml)	Sound Level (dB(A))	Temperature Setting Range (°C)	Temperature Accuracy (°C)	Speed Accuracy (rpm)	Timer
LX-155T500R	500-15500	26322	4*500	≤55	-20-40	±2	±10	1s-99h 59min59s
Power (W)	Power Supply (V/Hz)	External Dimensions (W*D*H)(mm)	Net Weight (kg)	Height of Lid Open (mm)	Packing Dimension (W*D*H)(mm)	Gross Weight (kg)	Certification	
1200	AC220, 50/60	658*673*358	112	860	760*815*590	133	CE	



\*Haier Biomedical reserves the right to change products and specifications without prior notice.



## Benchtop High-Speed Refrigerated Centrifuge

373/374

## Rotor Configuration List

No.	Model	Rotor Description	Max Capacity (ml)	Max RCF (xg)	Max Speed (rpm)	Singe Tube Capacity (ml)	Maximum Tube Dimensions (Ø*L)(mm)	Tube Type	Picture
1	BE12C9000	Fixed-Angle Rotor	24*1.5/2	23100	15500	1.5/2	11*38	Round/Conical	
2	Coming soon	Fixed-Angle Rotor	30*1.5/2	26322	15500	1.5/2	11*38	Round/Conical	
3	BE12C7000	Fixed-Angle Rotor	48*1.5/2	22132	14000	1.5/2	11*38	Round/Conical	
4	Coming soon	Fixed-Angle Rotor	12*10	16071	12500	10	16*86	Round	
5	Coming soon	Fixed-Angle Rotor	12*15	21912	14000	15	17*121	Conical	
6	Coming soon	Fixed-Angle Rotor	6*50	17065	12000	50	29*115	Round	
7	BE12DB000	Fixed-Angle Rotor	6*50	16421	12000	50	30*115	Conical	
Optional	Coming soon	Adapter	15-50	6 pcs/set		15	17*121	Conical	
8	Coming soon	Fixed-Angle Rotor	12*8*0.2	14892	12000	0.2	6*18	PCR	
9	BE12DF000	Fixed-Angle Rotor (Steel sleeves)	42*15	4472	5000	15	17*120	Round/Conical	
10	BE12DG000	Fixed-Angle Rotor (Steel sleeves)	12*50/15	4640	5000	50/15	30*104	Round/Conical	
11	BE12DE000	Fixed-Angle Rotor (Steel sleeves)	10*100	4500	3350	100	38*106	Round	
12	BE12F4001	Swing-out	4*500	4000	3184	500	Rotor block	/	
		Round Bucket	500	4000	3184	500	81*106	Flat	
Optional	BE12JP001	Adapter	4*250	4 pcs/set		250	62*123	Flat	
	Coming soon	Adapter	4*225	4 pcs/set		225	60*136	Conical	
	Coming soon	Adapter	4*100	4 pcs/set		100	38*106	Round	
	BE12JS001	Adapter	4*4*50	4 pcs/set		50	30*115	Conical	
	BE12JR001	Adapter	4*10*15	4 pcs/set		15	17*121	Conical	
	BE12JQ001	Adapter	4*14*10	4 pcs/set		10	15*105	Large blood collection tube	
	Coming soon	Adapter	4*19*7/5	4 pcs/set		2-5	12*80/105	Small/Large blood collection tube	
	Coming soon	Adapter	4*30*1.5	4 pcs/set		1.5	11*38	Round/Conical	
	BE12H5000	ELISA Plate Bucket	4*96 well plate	2612	4000	0.2	86*128	ELISA plate	

## Scope of Application

For the separation and purification of samples of cells, macromolecular proteins, blood, body fluids, DNA/RNA, plasmids, bacteria and viruses.



LX-185T100R

## Product Advantages

**Multi-level User Management**

Multi-level user management allows users to stored and organise personal data, centrifugal programs and operating parameters

**Real-time Monitoring and Alarms**

The sensor automatically monitors vibration in real time, and will stop and alarm when excess vibration is detected

**Smart and Intelligent Control**

Large smart screen controller provides an interactive interface which is easy to operate even in gloves

**Smart Anti Vibration Lock**

Automatic smart lock safeguards users

**Precise Temperature Control and Ultra-fast Refrigeration**

The fuzzy PID control with seamless evaporator to achieve precise temperature control and high-efficiency heat transfer

**Ergonomic Angled Touch Screen**

The 7-inch touchscreen is angled at 45° for to be comfortable and practical for users of all heights

**Precise Speed Control**

High-precision speed control technology to ensure the accuracy of experimental data

**Menu Driven Program**

Intelligent storage of centrifugal programs, quick access to programs

# Benchtop High-Speed Refrigerated Centrifuge

375/376

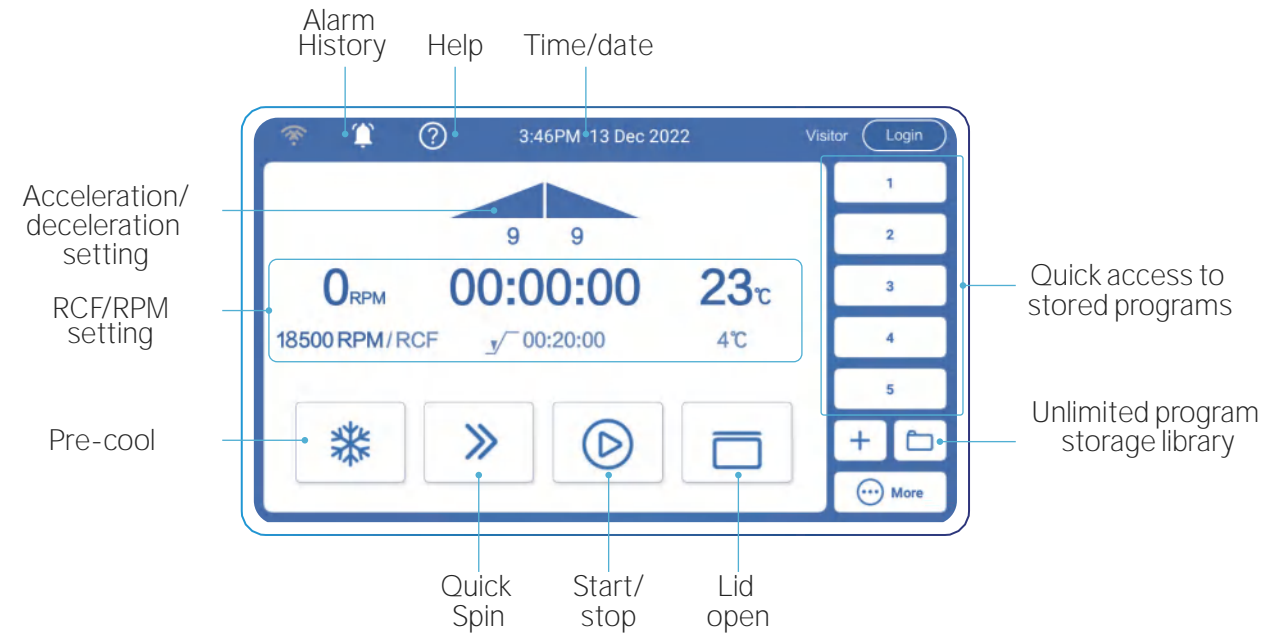

## Product Parts

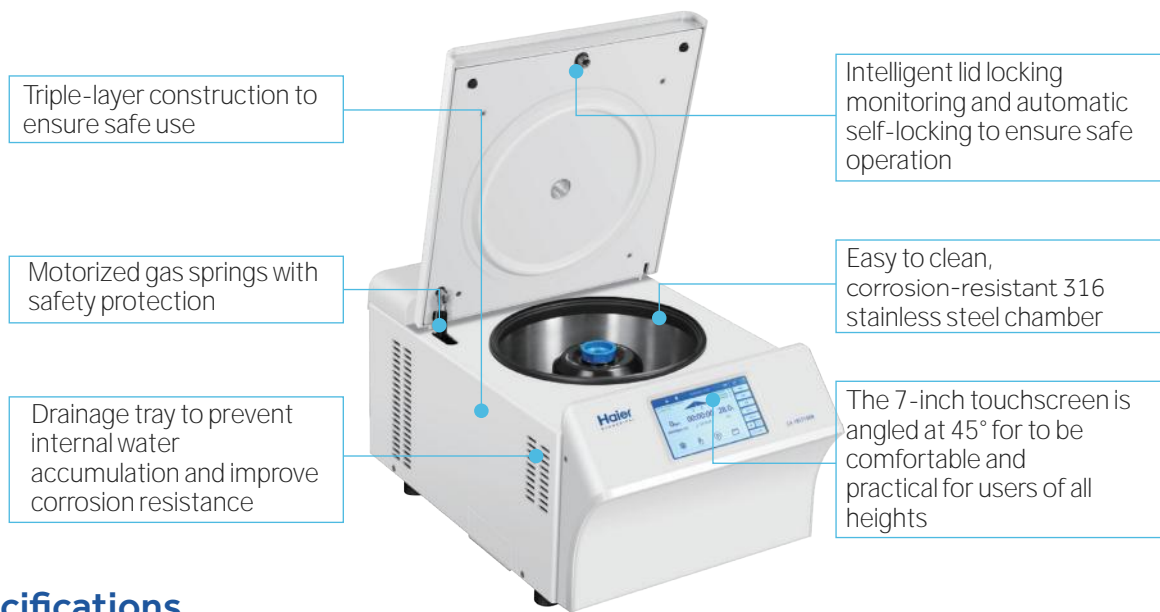

## Specifications

Model	Speed Range (r/min)	Max RCF (xg)	Max Capacity (ml)	Sound Level (dB(A))	Temperature Setting Range (°C)	Temperature Accuracy (°C)	Speed Accuracy (rpm)	Timer
LX-185T100R	500-18500	30130	4*100	≤52	-20-40	±2	±10	1s-99h 59min59s

Power (W)	Power Supply (V/Hz)	External Dimensions (W*D*H)(mm)	Net Weight (kg)	Height of Lid Open (mm)	Packing Dimension (W*D*H)(mm)	Gross Weight (kg)	Certification
1200	AC220, 50/60	420*680*330	57	860	525*820*555	73	CE

\*Haier Biomedical reserves the right to change products and specifications without prior notice.

## Rotor Configuration List

No.	Model	Rotor Description	Max Capacity (ml)	Max RCF (xg)	Max Speed (rpm)	Single Tube Capacity (ml)	Maximum Tube Dimensions (Ø*L)(mm)	Tube Type	Picture
1	Coming soon	Fixed-Angle Rotor	12*1.5/2	26019	18500	1.5/2	11*38	Round/Conical	
2	BE12C6000	Fixed-Angle Rotor	24*1.5/2	30130	17500	1.5/2	11*38	Round/Conical	
3	BE12CB000	Fixed-Angle Rotor	48*1.5/2	19083	13000	1.5/2	11*38	Round/Conical	
4	Coming soon	Fixed-Angle Rotor	12*5	18090	16000	5	14*55	Round	
5	BE12CC000	Fixed-Angle Rotor	12*10	16071	12500	10	16*86	Round	
6	BE12CA000	Fixed-Angle Rotor	8*15	13200	12000	15	17*121	Conical	
7	BE12CD000	Fixed-Angle Rotor	6*50	15294	12000	50	29*115	Round	
8	BE12DD000	Fixed-Angle Rotor	6*50	16421	12000	50	30*115	Conical	
Optional	Coming soon	Adapter	15-50	6 pcs/set		15	17*121	Conical	
9	Coming soon	Fixed-Angle Rotor	4*100	13257	11000	100	38*106	Round	
10	Coming soon	Fixed-Angle Rotor	12*8*0.2	18516	12000	0.2	6*18	PCR	
11	Coming soon	Fixed-Angle Rotor (Steel sleeves)	18*15	4749	5000	15	17*120	Round/Conical	
12	Coming soon	Fixed-Angle Rotor (Steel sleeves)	6*50/15	3577	5000	50/15	30*104	Round/Conical	
13	Coming soon	Fixed-Angle Rotor (Steel sleeves)	6*100	3348	4800	100	38*106	Round	
14	BE12FC001	Swing-out Rotor	ELISA Plate	2287	4500	0.2	Rotor block	Two position	
		ELISA Plate Bucket	2*96 well plate	2287	4500	0.2	86*128	ELISA Plate	
15	BE12FD001	Swing-out Rotor	4*50	2770	4200	/	Rotor block	/	
Optional	BE12H1000	Bucket	4*5*10/7	2770	4200	10	15*105	Large blood collection tube	
Optional	BE12JN001	Adapter	5	50 pcs/set	50 pcs/set	5	12*80	Small blood collection tube	
Optional	BE12H2000	Bucket	4*2*15	2770	4200	15	17*120	Round/Conical	
Optional	BE12H3000	Bucket	4*1*50	2770	4200	50	30*104	Round/Conical	

# Benchtop High-speed Refrigerated Centrifuge

377/378

## Scope of Application

Mainly used for nucleic acid extraction, DNA/RNA separation, purification, virus separation and protein precipitation in the laboratory. Widely used in universities, third party testing organizations, disease prevention, medical and health, biological pharmaceutical and other related fields.



LX-165T2R

## Product Advantages

### Smart and Intelligent Control

Large smart screen controller provides an interactive interface which is easy to operate even in gloves.

Set Timer

Temperature set-point and real-time temperature display.

Quick access to stored programs. Unlimited program storage, supports customised programs for safety.

Clear one-touch buttons for fast refrigeration, fast centrifugation, intelligent start-stop and lid-closing status.

Target speed/centrifugal force and real-time speed display.

## Intelligent Centrifugal Management System

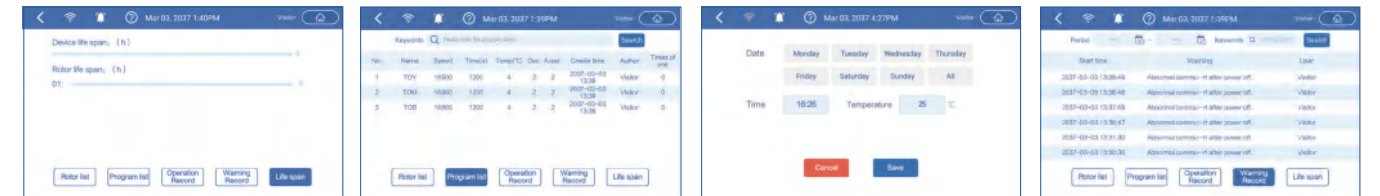

Operation failure detection, rotor and machine service life monitoring. Intelligent storage of centrifugal programs, quick access to programs. Fast refrigeration preset, saves time. View abnormal alarms

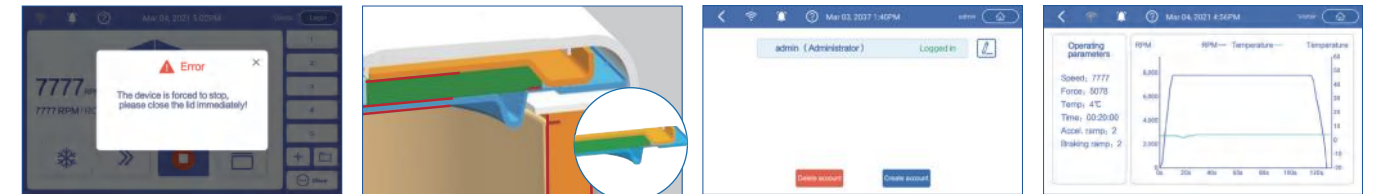

Intelligent lid locking monitoring and automatic self-locking to ensure safe operation. Safer by design, triple-layer construction to ensure safe use. Multi-level user management, effectively protects personal data. Intelligent monitoring of temperature, speed, vibration and rotor to ensure reliable operation.

## Auto-ID Instant Rotor Recognition and Rotor Service Life Statistics

- The Auto-ID rotor is instantly identified by the centrifuge upon installation; this ensures the rotor operates within safe limits.
- Rotor ID: Each rotor is equipped with a unique ID which enables traceability of rotor information.
- Rotor service life statistics: The rotor service time is recorded on the terminal and the centrifuge will alert users as the rotor reaches the end of its service life.

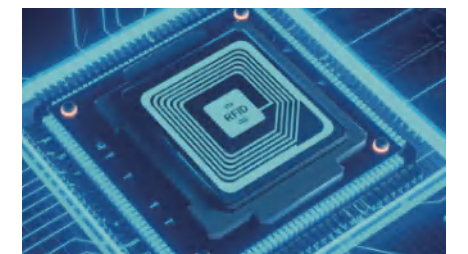

## Balance Detection

- Vibration monitoring for safe operation: The unit is designed with six-axis gyroscope technology, and if the vibration exceeds safe limits, the centrifuge will stop automatically.
- Rotor balancing detection: Dynamic monitoring of the centrifugal process means that the centrifuge will automatically shut down control in the event of a balance error.
- Centrifuge balancing detection: The built-in electronic gradienter automatically monitors the unit balancing status.

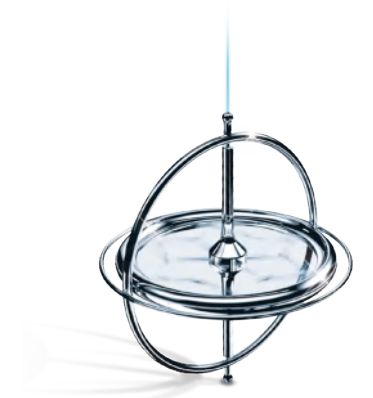



# Benchtop High-speed Refrigerated Centrifuge

379/380

## Precise Temperature Control and Ultra-fast Refrigeration

- Dual frequency conversion refrigeration technology ensures rapid refrigeration to reduce waiting time.
- High precision throttling technology proactive adjusts to provide precise temperature control.
- Seamless copper tube wrapping technology to achieve high efficiency heat transfer.

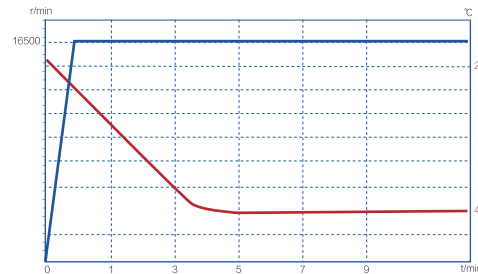

## Quality and Safety Guaranteed

- Extensive quality assurance and testing processes to ensure long-term reliability.
- High-precision speed control technology to ensure process integrity.
- Advanced dynamic balance monitoring technology to ensure the safe operation of the rotor.



## Ergonomic Design



### Ergonomic Design

Designed with multiple user applications, the touchscreen is angled to provide a clear view and is comfortable and practical for users of all heights.



### Smart Lid Lock

The automatic lid lock monitors the lid closing status, as the door is closed, it will tighten automatically indicating when the unit is safe to use.



### USB Interface



Data, such as operation records and error records, can be exported using a USB.

## Specifications

Model	Speed Range (r/min)	Max RCF (xg)	Max Capacity (ml)	Sound Level (dB(A))	Temperature Setting Range (°C)	Temperature Accuracy (°C)	Speed Accuracy (rpm)
LX-165T2R	500-16500	25872	12*5	≤52	-20-40	±2	±10

Timer	Power (W)	Power Supply (V/Hz)	External Dimensions (W*D*H)(mm)	Net Weight (kg)	Packing Dimension (W*D*H)(mm)	Gross Weight (kg)	Certification
1s-99h 59min59s	480	AC220, 50/60Hz	340*625*248	34	445*820*445	48	CE

\*Haier Biomedical reserves the right to change products and specifications without prior notice.

## Rotor Configuration List

No.	Model	Rotor Description	Max Capacity (ml)	Max RCF (xg)	Max Speed (rpm)	Maximum Tube Dimensions (Ø*L)(mm)	Tube Type	Picture
1	BE12C0Z00	Fixed Angle Rotor (Plastic Cover)	24*1.5/2	25872	16500	11*38	Round/Conical	
2	BE11D0Z00	Fixed Angle Rotor (Sealed)	24*1.5/2	21382	15000	11*38	Round/Conical	
3	BE12D0Z00	Fixed Angle Rotor (Sealed)	12*5	21407	15000	12*75	Round	
4	BE12E0Z00	PCR Fixed Angle Rotor	4*8*0.2	18891	15000	6*18	PCR	

# Benchtop High-Speed Centrifuge

381/382

## Scope of Application

For the separation and purification of samples of cells, macromolecular proteins, blood, body fluids, DNA/RNA, plasmids, bacteria and viruses.



LX-165T2-J

## Product Advantages



### Active Balance Detection

The machine has a high-sensitivity, six axis vibration detection mechanism. In case of abnormal vibration or rotor imbalance caused by non balancing, asymmetry, tube breakage and or rotor damage, an alarm will sound and the machine will stop immediately



### Multiple Damping and Noise Reduction Technology

Multiple anti-vibration technologies allow for low noise and smooth operation even at maximum speed (16,500rpm/58dB)



### High Efficiency Air Cooling Technology

Proprietary air duct structure design allows for quick dissipation of heat inside the centrifugal chamber



### Triple-layer Protection

Cabinet construction includes metal liner, fully covered steel plate protective sleeve and 3mm steel shell



### Anti Vibration Lid Lock

Anti-vibration lid lock ensures lid remains locked during excess vibration for user safety



### Automatic Rotor Identification

Automatic rotor identification limits maximum speed for safety

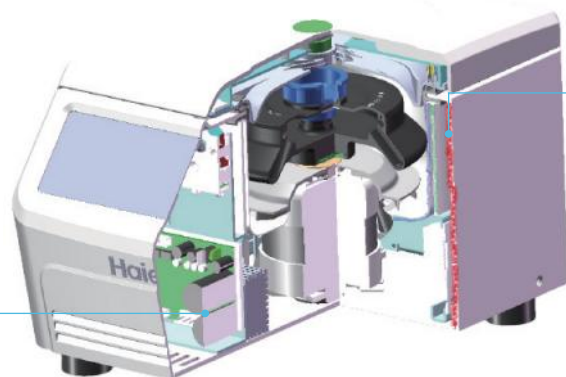

Triple-layer

Anti vibration lid lock

## Product Introduction

High efficiency air cooling technology

Active balance detection

Automatic rotor identification

Triple-layer protection to ensure safety

Large screen LCD display

One-click program selection

Multiple anti-vibration technologies allow for low noise and smooth operation even at maximum speed



## Specifications

Model	Speed Range (rpm)	Max RCF (xg)	Max Capacity (ml)	Speed Accuracy (rpm)	Time Set Range	Noise (dB)
LX-165T2-J	500-16500	25872	12*5.0	±10	1s-99h59min59s	≤58

Power Supply (V/Hz)	Power (W)	Exterior Dimensions (W*D*H)(mm)	Net Weight (Kg)	Packing Dimension (W*D*H)(mm)	Gross Weight (Kg)	Certification
220/50/60	230	375*270*252	18	585*395*400	20	CE

\*Haier Biomedical reserves the right to change products and specifications without prior notice.

## Rotor Configuration List

No.	Model	Rotor Description	Max Capacity (ml)	Max RCF (xg)	Max Speed (rpm)	Maximum Tube Dimensions (Ø*L)(mm)	Tube Type	Picture
1	BE12C5Z00	Fixed Angle Rotor (Plastic Cover)	24*1.5/2	25872	16500	11*38	Round/Conical	
2	BE12C4Z00	Fixed Angle Rotor (Sealed)	24*1.5/2	21382	15000	11*38	Round/Conical	
3	BE12D4Z00	Fixed Angle Rotor (Sealed)	12*5	21407	15000	12*75	Round	
4	BE12E4Z00	PCR Fixed Angle Rotor	4*8*0.2	18891	15000	6*18	PCR	

## Benchtop Low-speed Centrifuge

383/384

### Scope of Application

Low speed, non-refrigerated centrifuge suitable for the routine separation of particles and ideal for the analysis of blood and other biological samples. For low-medium throughput applications, for use with 15ml, 50ml and 100ml round and conical centrifuges tubes.



LX-60T100-J

### Product Advantages



#### Quality and Safety

- Imbalance detection for maximum safety
- Stainless steel rotor chamber is corrosion-resistant and easy to clean
- Triple-layer protection to ensure safety
- Patented anti-vibration safety lid lock



#### Intelligent Design

- High efficiency air cooling technology minimises warming to protect samples
- Multiple vibration and noise reduction technologies ensure quiet and stable operation
- A choice of rotors including large capacity rotor and a dual capacity rotor (15ml/50ml)



#### Convenient Operation

- One-click program selection for improved work efficiency
- Automatic rotor identification
- Simultaneous display of both set and actual speed and time, which can be adjusted as required. Users can set operation and switch between relative centrifugal force (rcf) and speed (rpm) as needed.

### Product Introduction



### Specifications

Model	Speed Range (rpm)	Max RCF (xg)	Max Capacity (ml)	Speed Accuracy (rpm)	Time Set Range	Noise (dB)
LX-60T100-J	500-6000	4749	6*100	±10	1s - 99h59min59s	≤56

Power Supply (V/Hz)	Power (W)	Exterior Dimensions (W*D*H)(mm)	Net Weight (Kg)	Packing Dimension (W*D*H)(mm)	Gross Weight (Kg)	Certification
220/50/60	150	447*281*340	25	565*460*430	28	CE

\*Haier Biomedical reserves the right to change products and specifications without prior notice.

### Rotor Configuration List

No.	Model	Rotor Description	Max Capacity (ml)	Max RCF (xg)	Max Speed (rpm)	Maximum Tube Dimensions (Ø*L)(mm)	Tube Type	Picture
1	BE11D5000	Fixed-Angle Rotor (Steel sleeves)	12*15	4749	6000	17*120	Round/Conical	
2	BE11D6000	Fixed-Angle Rotor (Steel sleeves)	6*50/15	3577	5000	30*104	Round/Conical	
	BE11DT000	Fixed-Angle Rotor (Steel sleeves)	18*15	3577	5000	17*120	Round/Conical	
3	BE11D7000	Fixed-Angle Rotor (Steel sleeves)	6*100	3348	4800	38*106	Round	
4	Coming soon	Fixed-Angle Rotor (Steel sleeves)	12*10	2753	5000	15*105	Large blood collection tube	
5	BE11DU000	Fixed-Angle Rotor (Steel sleeves)	36*10	2465	4200	15*105	Large blood collection tube	
Optional	BE12JN001	Adapter	50 pcs/set	/	/	12*80	Small blood collection tube	
6	BE12F2001	Swing-out Rotor Block	4*50	2770	4200	Rotor block	/	
Optional	Coming soon	Bucket	4*1*15 4*2*10 4*2*5	2770	4200	17*121 17*96 12*79	Applicable to reproductive sciences	
	BE12H1000	Bucket	4*5*10/7	2770	4200	15*105	Large blood collection tube	
	BE12JN001	Adapter	50 pcs/set			12*80	Small blood collection tube	
	BE12H2000	Bucket	4*2*15	2770	4200	17*120	Round/Conical	
	BE12H3000	Bucket	4*1*50	2770	4200	30*104	Round/Conical	
7	BE12F3001	Swing-out Rotor	2*96 well plate	1932	4000	86*128	ELISA Plate	



# Benchtop Low-speed Centrifuge

385/386

## Scope of Application

Low speed, large capacity non-refrigerated centrifuge suitable for the routine separation of particles and ideal for the analysis of blood and other biological samples. For low-medium throughput applications, for use with 15ml, 50ml, 100ml, 250ml, and 500ml round and conical centrifuges tubes.



LX-60T500-J

## Product Advantages



### Convenient Operation

- One-click program selection for improved work efficiency
- Automatic rotor identification
- Large capacity with multiple rotors for optimal use
- Simultaneous display of both set and actual speed and time, which can be adjusted as required. Users can set operation and switch between relative centrifugal force (rcf) and speed (rpm) as needed



### Intelligent Design

- High efficiency air cooling technology minimises warming to protect samples
- Multiple vibration and noise reduction technologies ensure quiet and stable operation
- A choice of rotors including large capacity rotor and a dual capacity rotor (15ml/50ml)



### Quality and Safety

- Imbalance detection for maximum safety
- Stainless steel rotor chamber is corrosion-resistant and easy to clean
- Triple-layer protection to ensure safety
- Patented anti-vibration safety lid lock

## Product Introduction



## Specifications

Model	Speed Range (rpm)	Max RCF (xg)	Max Capacity (ml)	Speed Accuracy (rpm)	Time Set Range	Noise (dB)
LX-60T500-J	6000	5353	4*500	±10	1s - 99h59min59s	≤65
Power Supply (V/Hz)	Power (W)	Exterior Dimensions (W*D*H)(mm)		Net Weight (Kg)	Packing Dimension (W*D*H)(mm)	Gross Weight (Kg)
AC220-50/60	700	624*478*365		60	770*580*580	75

\*Haier Biomedical reserves the right to change products and specifications without prior notice.

## Rotor Configuration List

No.	Model	Rotor Description	Max Capacity (ml)	Max RCF (xg)	Max Speed (rpm)	Maximum Tube Dimensions (Ø*L)(mm)	Tube Type	Picture
1	Fixed-Angle Rotor (Steel sleeves)	6*50-15	5353	6000	50/15	30*104	Round bottom/Conical bottom	
	Fixed-Angle Rotor (Steel sleeves)	12*15	5353	6000	15	17*121	Round bottom/Conical bottom	
2	Fixed-Angle Rotor (Steel sleeves)	42*15	4528	5000	15	17*121	Round bottom/Conical bottom	
	Fixed-Angle Rotor (Steel sleeves)	12*50 (15)	4528	5000	50/15	30*104	Round bottom/Conical bottom	
3	Fixed-Angle Rotor (Steel sleeves)	10*100	3260	4500	100	38*106	Round bottom	
4	Fixed-Angle Rotor (Steel sleeves)	60*10	2897	4000	10	15*105	Round bottom/Conical bottom	
5	Fixed-Angle Rotor (Steel sleeves) For blood bank	12*10	1511	4000	10	15*105	Round bottom/Conical bottom	
6	Swing-out Rotor	4*500	3220	4000	500	Rotor block	Four position	
Standard	Round Bucket	4*500	3220	4000	500	81*106	Flat bottom	
	Adapter	4*250	4pcs/set		250	62*123	Flat bottom	
	Adapter	4*100	4pcs/set		100	38*106	Round bottom	
	Adapter	4*4*50	4pcs/set		50	30*115	Conical bottom	
	Adapter	4*10*15	4pcs/set		15	17*121	Conical bottom	
	Adapter	4*19*7/5	4pcs/set		2-7	12*80/105	Small/Large blood collection tube	
	Adapter	4*30*1.5	4pcs/set		1.5	11*38	Round bottom/Conical bottom	
	Conical Bucket	4*500	3220	4000	500	94*105	Conical bottom	
	Adapter	4*250	4pcs/set		250	60*165	Conical bottom	
	Automatic Decap Bucket	4*24*10	3220	4000	10	15*105	Large blood collection tube	
Decap Adapter	4*24*10	4pcs/set		10	15*105	Large blood collection tube		
7	Swing-out Bucket Rotor	4*96 well plate	2612	4000	0.2	86*128	ELISA plate	

## Mini-Centrifuge

387/388

## Scope of Application

This product is used in micro centrifugal scenarios (single tube capacity is less than or equal to 2ml)



LX-120T2Z



LX-50T2Z

## Product Advantages

**Convenient**

Simple and fast operation

**Small**

Can be held in your hand

**Safe**

- Safety interlock lid with automatic shut-off if lid is open
- Anti vibration & absorption suction cup
- Splash and leak protection

**Quiet**

Suspension with shock absorber reduces noise output

## Applicable Users

- PCR laboratory
- Microbiological laboratory
- Public health and disease control
- Chemistry and chemical laboratory
- Scientific research biology laboratory in colleges and universities
- Medical treatment and hospital testing room

## Specifications

Model	LX-120T2Z	LX-50T2Z
Speed Range (rpm)	500-12000	5000
Max RCF (xg)	7325	1270
Max Capacity (ml)	8*1.5/2.0	8*1.5/2.0
Speed Accuracy (%)	±5	±5
Timer	10 seconds-99 minutes 50 seconds	-
Display	OLED	-
Sound Level (dB(A))	50	40
Unbalance Protection	Y	N
Power	AC 100-240V/50-60Hz	AC 100-240V/50-60Hz
Rated Power Consumption (W)	35	25
Exterior Dimension (W*D*H)(mm)	152*142*122	152*142*122
Net Weight (kg)	1.2	1.2

\*Haier Biomedical reserves the right to change products and specifications without prior notice.

## Rotor Configuration List

Model	LX-120T2Z	LX-50T2Z
Rotor 01	8*1.5/2.0ml	8*1.5/2.0ml
Max Speed (rpm)	12000	5000
Max RCF (xg)	7325	1270
Max Capacity (ml)	8*2	8*2
Adapter (ml)	0.5/0.2	0.5/0.2
Rotor 02	PCR 8*2.0	PCR 8*2.0
Max Speed (rpm)	12000	5000
Max RCF (xg)	6625	1150
Max Capacity (ml)	0.2*8*2	0.2*8*2

## Centrifuge Consumables

389/390

Haier Biomedical manufactures and supplies a full compliment of premium quality centrifuge consumables suitable for a various applications and compatible with its range of centrifuges.

### Centrifuge Bottle



#### Product Features

- Unique design for highly-effective two-way sealing
- Design increases max centrifugal limits
- Temperature range: -80°C-120°C
- Clear scale for accurate and convenient data reading
- Sterile and RNase, DNase, human DNA and Pyrogen Free

CAT.NO.	Description	Max. RCF (xg)	Packing Specification
321007	225ml centrifuge bottle, sterile	6000	6pcs/bag, 6bags/case
321008	250ml centrifuge bottle, sterile	6000	6pcs/bag, 17bags/case
321009	500ml centrifuge bottle, sterile	6000	6pcs/bag, 6bags/case

### Centrifuge Tubes



#### Product Features

- Tube and lid made of medical-grade polypropylene (PP) USP Class VI standards
- 15ml/50ml conical bottom design, high clarity, clear black line scale and pre-set white writing area
- The double-threaded tube cap is easy to grip for single-handed operation and reliable sealing
- Flat cap design; the cap top can be used as a sample information marking area
- RNase and DNase Free
- Gamma sterilized, sterile and pyrogen-free
- Various packaging options, including sterile racked packing, sterile bag-packed bulk packing, and non-sterile packing.



A large white frosted writing area



Flat and frosted tube cap facilitates marking



Clear printed scale

CAT.NO.	Description	Max. RCF (xg)	Packing Specification
311005	15ml centrifuge tube, sterile	12000	25pcs/bag, 20bags/box
311006	50ml centrifuge tube, sterile	12000	25pcs/bag, 20bags/box



## Microcentrifuge Tubes



Haier Biomedical's range of PCR centrifuge consumables include single tubes, 8-tube strips and different 96 well plate options.

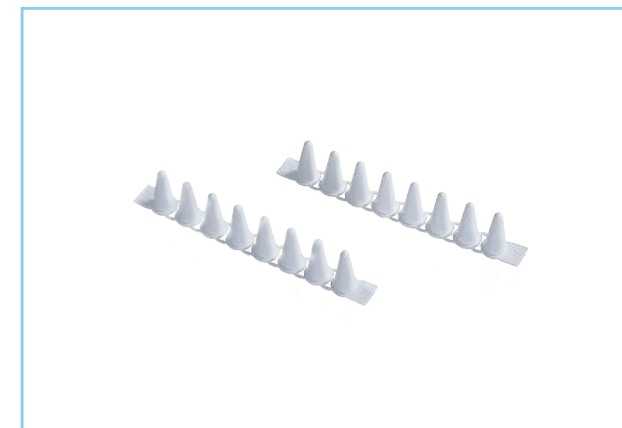
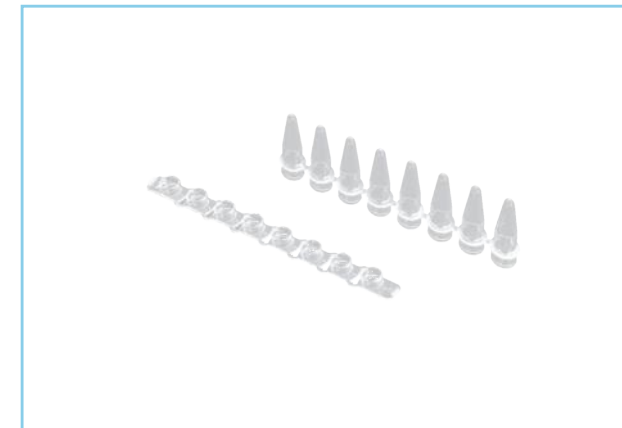

### Product Features

- Made of USP Class VI, medical-grade polypropylene (PP), free from release agent, plasticizer, bacteriostatic agent, and heavy metals
- High-clarity tube for convenient sample observation
- The unique cap design with flat surface for writing, delivers enhanced sealing and enables single-handed operation
- Temperature range: -80°C-120°C



Ultra-high clarity makes samples clearly visible  
Universal design suitable for all major brands



Frosted writing area



Snap-on safety cap to ensure safe centrifugation to maximize operational safety during centrifugation

CAT.NO.	Description	Max. RCF (xg)	Packing Specification
311001	0.6ml microcentrifuge tube, non-sterile	20000	1000pcs/box, 10box/ctn
311002	1.5ml microcentrifuge tube, non-sterile	20000	500/box, 10boxes/case
311004	2.0ml microcentrifuge tube, non-sterile	20000	500/box, 10boxes/case

## PCR Tube Strips

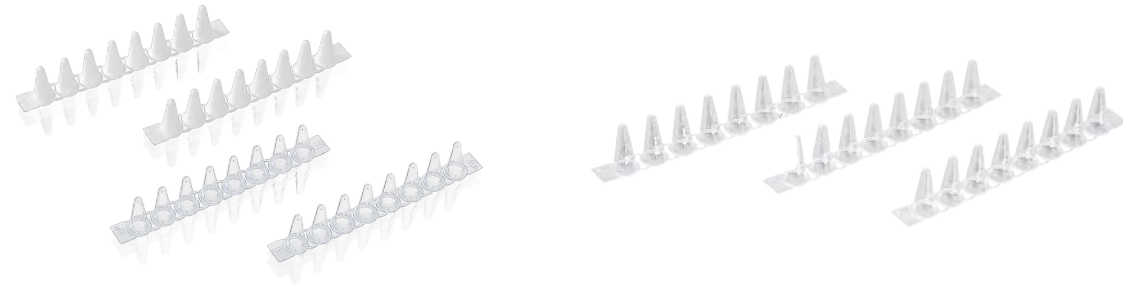

### Product Features

- Made from pure polypropylene, it has thin and uniform wall for optimal heat transfer
- The easy-to-open tube and tube lid fasten securely to prevent evaporation and leakage
- RNase, DNase, human DNA and Pyrogen Free
- Suitable for the mainstream PCR and real-time PCR instruments

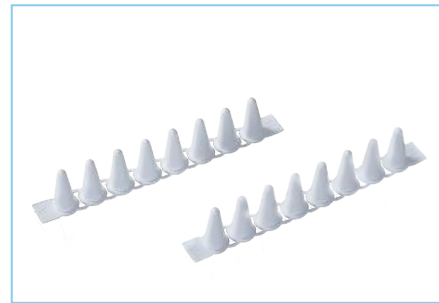
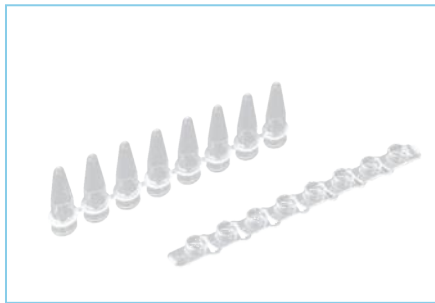

CAT.NO.	Description	Unit Quantity	Packing Specification
211001	0.2ml PCR single tube, thin-wall, flat cover	10000	500pcs/bag, 2bags/box, 10boxes/case
222002	0.1ml PCR 8-strip tube (with flat cover)	1250	125sets/bag, 10bags/case
222003	0.1ml PCR 8-strip tube (with flat cover), white	1250	125sets/bag, 10bags/case
292004	0.1ml PCR 8-strip tube--type B (with flat cover)	1250	125sets/bag, 10bags/case
292005	0.1ml PCR 8-strip tube--type B (with flat cover), white	1250	125sets/bag, 10bags/case
292006	0.2ml PCR 8-strip tube--type B (with flat cover)	1250	125sets/bag, 10bags/case
292007	0.2ml PCR 8-strip tube--type B (with flat cover), white	1250	125sets/bag, 10bags/case
222008	0.2ml PCR 8-strip tube (with flat cover)	1250	125strips/bag, 10bags/case
272009	0.2ml PCR 8-strip tube (with convex cover)	1250	125sets/bag, 10bags/case

## PCR 96-Well Plates



### Product Features

- High-quality polypropylene, manufactured in accordance with high quality standards to produce a reliable plate, delivering excellent uniformity across experiments.
- With a maximum volume of 0.3ml, it is suitable for 0.2ml PCR instruments
- The thin wall of the tube ensures uniform heat transfer and superior light transmittance
- The whole surface of the plate is smooth, firm, and resists deformation
- RNase, DNase, human DNA and Pyrogen Free



Clear and easy to read and easy to operate and identify



Prominent open profile reduces the risk of cross contamination

CAT.NO.	Description	Unit Quantity	Packing Specification
232024	0.2ml 96-well PCR plate, no skirt edge	50	10pcs/box, 5boxes/case
242025	0.2ml 96-well PCR plate, half skirt edge	50	10pcs/box, 5boxes/case
242026	0.2ml 96-well PCR plate, half skirt edge, high-temperature-resistant and anti-static	50	10pcs/box, 5boxes/case
232029	0.1ml 96-well PCR plate, no skirt edge	50	10pcs/box, 5boxes/case
242030	0.1ml 96-well PCR plate, half skirt edge	50	10pcs/box, 5boxes/case
242031	0.1ml 96-well PCR plate, half skirt edge, high-temperature-resistant and anti-static	50	10pcs/box, 5boxes/case
252032	0.1ml 96-well PCR plate, full skirt edge	50	10pcs/box, 5boxes/case
252035	0.1ml 96-well PCR plate with full skirt, H1 cutting angle, dual material (plate color random)	50	10pcs/box, 5boxes/case
252033	0.1ml 96-well PCR plate, full skirt edge, high-temperature-resistant and anti-static	50	10pcs/box, 5boxes/case

LN<sub>2</sub> Storage





## Biobank Series for Large Scale Storage

397/398

*Biobank series for large scale storage is designed to ensure the maximum storage capacity with the minimum consumption of liquid nitrogen to lower the overall cost of operation.*

- LN<sub>2</sub> Splash Proof
- Data Logging
- Hot Gas Bypass
- 5 Years Vacuum Warranty
- From 13,000 to 94,875 Cryovials
- IoT Enabled
- Vapour Phase Storage
- Lockable Lid
- Liquid Phase Storage
- One-touch Defogging
- Cryosmart Control System

### Key Features

- Massive capacity between 13,000 to 94,875×2ml Vials
- Vapour phase storage is the only guaranteed method to prevent cross-contamination
- Vapour phase storage at -190°C
- 5-Year vacuum warranty
- One-touch defogging for easier access
- LN<sub>2</sub> splash proof ensures a safer operation
- Suitable for wide variety of sample storage

### Product Advantages

#### Optimal Use of Storage Space

Racks are stored on the rotating tray with an appropriate distance from the wall of the chamber. Liquid nitrogen or supercooled nitrogen vapour is filled in the space between the tray and the wall to maintain temperature uniformity. Storage space is equally divided into four or six fan-shaped storage areas which are clearly labelled. Each storage room is easily rotated to the opening of the tank for convenient sample access.



#### Designed for Both Liquid and Vapor Phase Storages

Each model from the Biobank series for large scale storage is designed for both liquid and vapor phase storage. For the vapor phase storage operation process, samples are located away from the liquid nitrogen at a uniform temperature close to that of liquid nitrogen.

#### Advanced Vacuum Technology and Superinsulation Technology

Haier Biomedical's Liquid Nitrogen Storage System Biobank series for large scale storage applies advanced vacuum technology and superinsulation technology to ensure storage safety and temperature uniformity while reducing the consumption of liquid nitrogen. The temperature difference of the entire storage area does not exceed 10°C, even during the vapor phase storage process, the temperature near the top of the shelf is as low as -190°C.

#### Cryosmart Level Monitoring System ITC-800N201(N4.1)

Haier Biomedical's Liquid Nitrogen Storage System Biobank series for large scale storage feature the Cryosmart system for complete monitoring and control. High-precision temperature and liquid level sensors are used to ensure accuracy. All data and samples are protected by a secure access control system.





# Biobank Series for Large Scale Storage

399/400



The unique design can reduce the amount of water vapor solidification on the outer surface of the neck, the container is reinforced at liquid nitrogen temperature to extend the physical service life of the container.

The stainless steel liquid nitrogen biological container can be connected to self-pressurized supply tank, ideally suited for one or two sample storage containers.



## Liquid and Gas Phase

### Liquid Phase

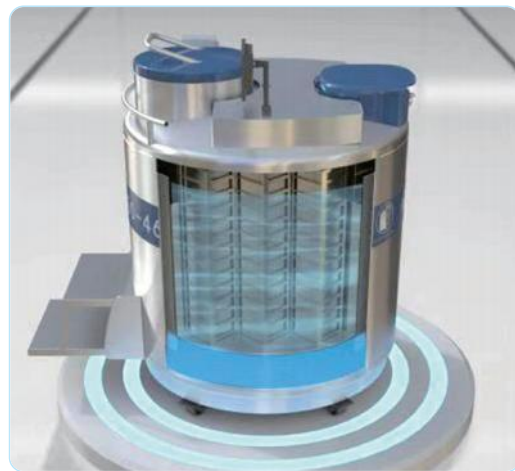

### Gas Phase

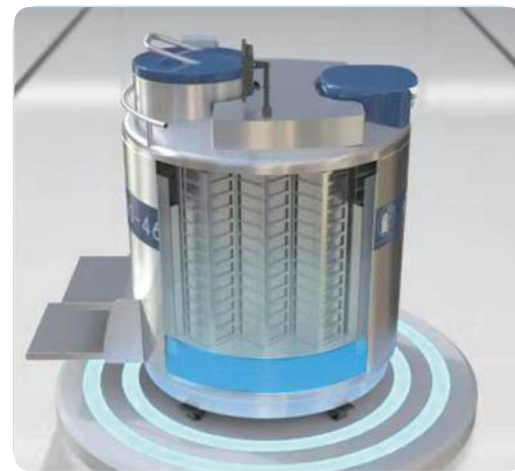

### Top of the Container



### Liquid Feed System



## Temperature Test Graph

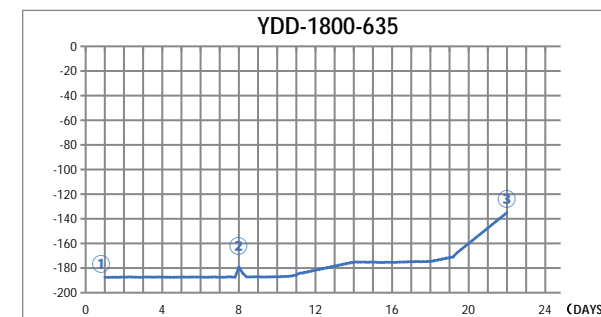

- ① Precooling stage when freezer filled to high level
- ② Lid open test, -179.2°C max
- ③ With no liquid nitrogen supply, the temperature maintained below -135°C for 22 days

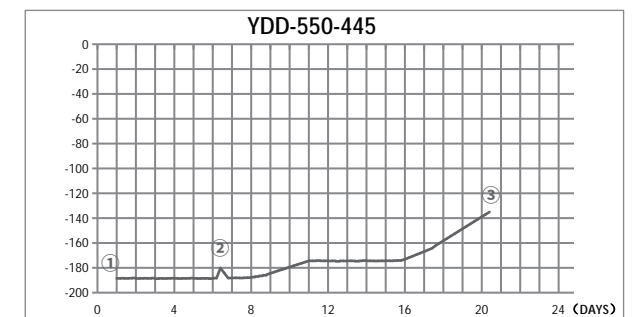

- ① Precooling stage when freezer filled to high level
- ② Lid open test, -180.2°C max
- ③ With no liquid nitrogen supply, the temperature maintained below -135°C for 20 days

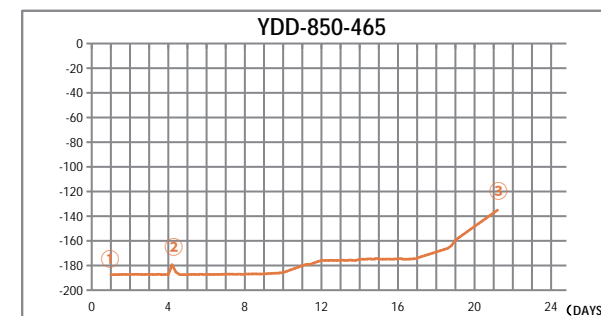

- ① Precooling stage when freezer filled to high level
- ② Lid open test, -179.4°C max
- ③ With no liquid nitrogen supply, the temperature maintained below -135°C for 21 days

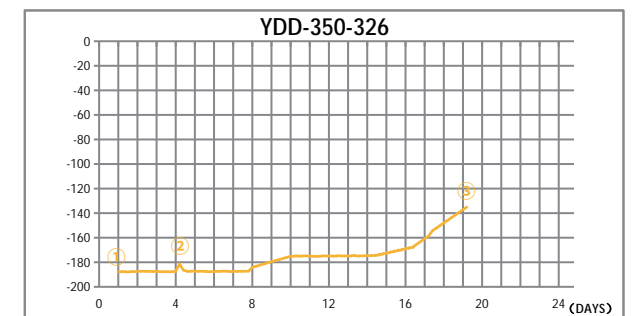

- ① Precooling stage when freezer filled to high level
- ② Lid open test, -181.4°C max
- ③ With no liquid nitrogen supply, the temperature maintained below -135°C for 19 days

Temp Test indicates typical performance of Haier Biobank freezer with factory recommended level settings. Actual performance may vary with atmospheric conditions and usage.

# Biobank Series for Large Scale Storage

401/402



## Technical Parameters

Model	YDD-350-326/PM	YDD-370-326/PM	YDD-450-326/PT	YDD-550-445/PM	YDD-750-445/PM
2ml Volume	13K	16K	21K	27K	38K
<b>Maximum Storage Capacity</b>					
2 ml Vials (Internal Thread)	13000	15600	21000	27000	37800
Freeze Rack (100 wells)	12	12	12	24	24
Freeze Rack (25 wells)	4	4	8	12	12
Layers of each Rack	10	12	15	10	14
5 ml Vials (Internal Thread)	5360	6432	10548	11220	17952
Freeze Rack (81 wells)	12	12	12	24	24
Freeze Rack (25 wells)	4	4	8	12	12
Layers of each Rack	5	6	9	5	8
<b>Performance</b>					
Volume of LN <sub>2</sub> (L)	350	370	480	587	783
Volume of LN <sub>2</sub> under the Tray (L)	55	55	55	80	80
<b>Dimensions</b>					
Inside Neck Diameter (mm)	326	326	326	445	445
Effective Internal Height (mm)	600	704	900	600	828
Height (mm)	1263	1370	1570	1266	1486
Operating Height (mm)	1263	1096	1060	1266	995
Outside Diameter (mm)	875	875	875	1104	1104
Door Width Requirement (mm)	895	895	895	1124	1124
Empty Weight (kg)	245	283	308	328	372
Full Weight (kg)	528	582	696	802	1005
Shipping Weight (kg)	384	536	501	520	616

## Blood Bag Capacity

Model	YDD-350-326/PM			YDD-370-326/PM			YDD-450-326/PT			YDD-550-445/PM			YDD-750-445/PM		
Bag Specifications	Total No. of Bags	Rack Layers	No. of Racks	Total No. of Bags	Rack Layers	No. of Racks	Total No. of Bags	Rack Layers	No. of Racks	Total No. of Bags	Rack Layers	No. of Racks	Total No. of Bags	Rack Layers	No. of Racks
25ml (791 OS/U)	1176	6	196	1372	7	196	1602	9	178	2208	6	368	2944	8	368
50ml (4R9951)	720	6	120	840	7	120	990	9	110	1392	6	232	1856	8	232
250ml (4R9953)	264	3	88	352	4	88	450	5	90	516	3	172	860	5	172
500ml (DF-200)	168	3	56	168	3	56	270	5	54	336	3	112	560	5	112
500ml (4R9955)	144	3	48	192	4	48	370	5	74	288	3	96	480	5	96
700ml (DF - 700)	96	3	32	96	3	32	260	5	52	204	3	68	272	4	68



## Technical Parameters

Model	YDD-850-465/PM	YDD-1000-465/PT	YDD-1300-635/PM	YDD-1600-635/PM	YDD-1800-635/PT
2ml Volume	43K	51K	59K	76K	95K
<b>Maximum Storage Capacity</b>					
2 ml Vials (Internal Thread)	42900	51000	58500	76050	94875
Freeze Rack (100 wells)	32	30	54	54	60
Freeze Rack (25 wells)	4	16	18	18	13
Layers of each Rack	13	15	10	13	15
5 ml Vials (Internal Thread)	18844	25470	28944	33768	46665
Freeze Rack (81 wells)	32	30	54	54	60
Freeze Rack (25 wells)	4	16	18	18	13
Layers of each Rack	7	9	6	7	9
<b>Performance</b>					
Volume of LN <sub>2</sub> (L)	890	1014	1340	1660	1880
Volume of LN <sub>2</sub> under the Tray (L)	135	135	265	300	320
<b>Dimensions</b>					
Inside Neck Diameter (mm)	465	465	635	635	635
Effective Internal Height (mm)	773	900	620	791	900
Height (mm)	1499	1619	1341	1534	1661
Operating Height (mm)	980	1090	997	967	1097
Outside Diameter (mm)	1190	1190	1565	1565	1565
Door Width Requirement (mm)	1210	1210	1585	1585	1585
Empty Weight (kg)	441	495	851	914	985
Full Weight (kg)	1160	1314	1934	2255	2504
Shipping Weight (kg)	702	926	1168	1426	1520

## Blood Bag Capacity

Model	YDD-850-465/PM			YDD-1000-465/PT			YDD-1300-635/PM			YDD-1600-635/PM			YDD-1800-635/PT		
Bag Specifications	Total No. of Bags	Rack Layers	No. of Racks	Total No. of Bags	Rack Layers	No. of Racks	Total No. of Bags	Rack Layers	No. of Racks	Total No. of Bags	Rack Layers	No. of Racks	Total No. of Bags	Rack Layers	No. of Racks
25ml (791 OS/U)	2996	7	428	3852	9	428	4536	6	756	5292	7	756	7218	9	802
50ml (4R9951)	1904	7	272	2394	9	266	2808	6	468	3276	7	468	4446	9	494
250ml (4R9953)	832	4	208	1020	5	204	1062	3	354	1770	5	354	1940	5	388
500ml (DF-200)	544	4	136	670	5	134	666	3	222	888	4	222	1290	5	258
500ml (4R9955)	464	4	116	520	5	104	594	3	198	792	4	198	1090	5	218
700ml (DF - 700)	320	4	80	400	5	80	396	3	132	528	4	132	775	5	155



# Biobank Series for Large Scale Storage

## Racks (vertical type) and Blood bag Frame

	Racks (vertical type)	25 ml Blood bag Frame	50 ml Blood bag frame
YDD-350-326/PM YDD-370-326/PM			
YDD-450-326/PT			
YDD-550-445/PM YDD-750-445/PM			
YDD-850-465/PM			
YDD-1000-465/PT			
YDD-1300-635/PM YDD-1600-635/PM			
YDD-1800-635/PT			

## Biological Sample Bank-YDD Series

### Storage Example of 2ml Internally Threaded Vial



### Storage Example of Tall 5ml Cryovials

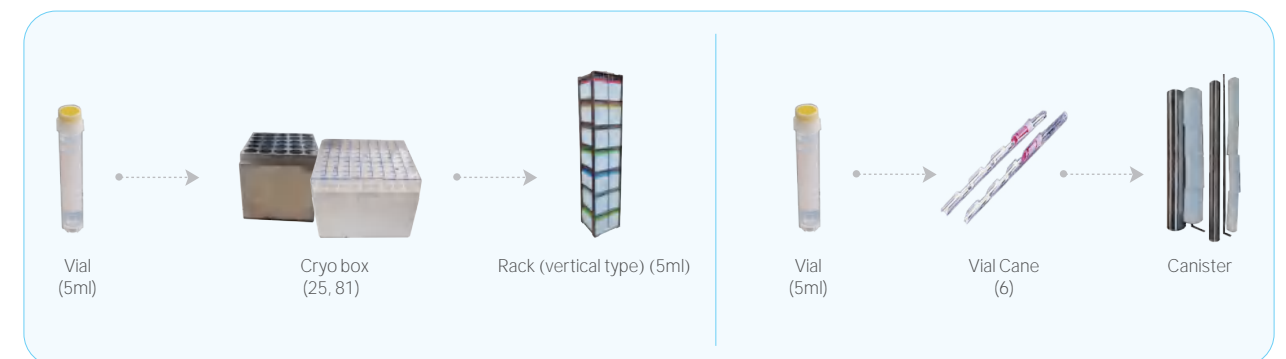

### Blood Bag Storage Example

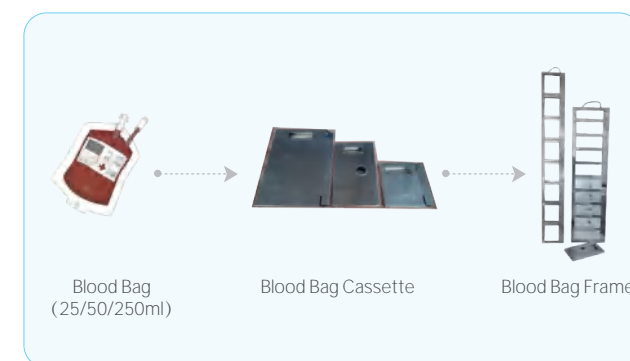

### Straw Storage Example

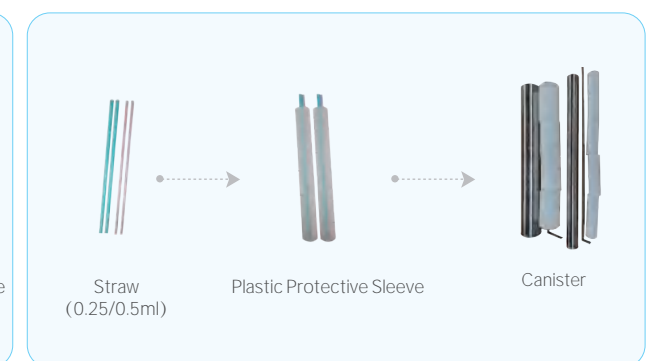

# Biobank Series for Large Scale Storage

## Product List

Model	Product	Product Model	Factory Code	Description and Accessories
YDD-350-326/PM (13K)	Biobank freezer (smart type)	YDD-350-326/PM	YDD-350-326/PM-K82J2H	Includes vacuum isolated hose (GRG-DN10/2.0), 4pcs of 10-tier rack (5*5), 12 pcs of 10-tier rack (9*9), 40pcs of cryo boxes for 2ml vial (5*5), 120pcs of cryo boxes for 2ml vial (9*9), 1 set of cryosmart (level monitoring system)
	Biobank freezer	YDD-350-326/PM	YDD-350-326/PM-W	Includes vacuum isolated hose (GRG-DN10/2.0), Rack and intelligent level monitoring system are optional
	Rack (vertical type)	FDCJ-25-10	FDCJ-25-10	Used for storing 5*5 cryoboxes (2ml), ten layers in total, suitable for YDD-350/550/1300 (excluding cryoboxes)
	Rack (vertical type)	FDCJ-81-10	FDCJ-81-10	Used for storing 9*9 cryoboxes (2ml), Ten layers in total, Suitable for YDD-350/550/1300 (excluding cryoboxes)
	Plastic cryo box	FH-25	FH-25	Used for storing 1.8ml/2ml vial (25 holes)
	Plastic cryo box	FH-81	FH-81	Used for storing 1.8ml/2ml vial (81 holes)
	Plastic cryo box	FH-100	FH-100	Used for storing 1.8ml/2ml vial (interally threaded, 100 holes)
	Cryosmart level monitoring system	ITC-800N-201	ITC-800N-201	Suitable for all capacitive measurement of gas phase liquid nitrogen containers, including the liquid inlet system and excluding the wireless data transmission module
YDD-370-326/PM (16K)	Biobank freezer (smart type)	YDD-370-326/PM	YDD-370-326/PM-K82J2H	Includes vacuum isolated hose (GRG-DN10/2.0), 4pcs of 12-tier rack (5*5), 12 pcs of 12-tier rack (9*9), 48pcs of cryo boxes for 2ml vial (5*5), 144pcs of cryo boxes for 2ml vial (9*9), 1 set of cryosmart (level monitoring system)
	Biobank freezer	YDD-370-326/PM	YDD-370-326/PM-W	Includes vacuum isolated hose (GRG-DN10/2.0), Rack and intelligent level monitoring system are optional
	Rack (vertical type)	FDCJ-25-12	FDCJ-25-12	Used for storing 5*5 cryoboxes (2ml), Twelve layers in total, suitable for YDD-370 (excluding cryoboxes)
	Rack (vertical type)	FDCJ-81-12	FDCJ-81-12	Used for storing 9*9 cryoboxes (2ml), Twelve layers in total, suitable for YDD-370 (excluding cryoboxes)
	Plastic cryo box	FH-25	FH-25	Used for storing 1.8ml/2ml vial (25 holes)
	Plastic cryo box	FH-81	FH-81	Used for storing 1.8ml/2ml vial (81 holes)
	Plastic cryo box	FH-100	FH-100	Used for storing 1.8ml/2ml vial (interally threaded, 100 holes)
	Cryosmart level monitoring system	ITC-800N-201	ITC-800N-201	Suitable for all capacitive measurement of gas phase liquid nitrogen containers, including the liquid inlet system and excluding the wireless data transmission module
YDD-450-326/PT (21K)	Biobank freezer (smart type)	YDD-450-326/PT	YDD-450-326/PT-K82J2H	Includes vacuum isolated hose (GRG-DN10/2.0), 8pcs of 15-tier rack (5*5), 12 pcs of 15-tier rack (9*9), 120pcs of cryo boxes for 2ml vial (5*5), 180pcs of cryo boxes for 2ml vial (9*9), 1 set of cryosmart (level monitoring system)
	Biobank freezer	YDD-450-326/PT	YDD-450-326/PT-W	Includes vacuum isolated hose (GRG-DN10/2.0), Rack and intelligent level monitoring system are optional
	Rack (vertical type)	FDCJ-25-15	FDCJ-25-15	Used for storing 5*5 cryoboxes (2ml), Fifteen layers in total, suitable for YDD-450/1000/1800 (excluding cryoboxes)
	Rack (vertical type)	FDCJ-81-15	FDCJ-81-15	Used for storing 9*9 cryoboxes (2ml), Fifteen layers in total, suitable for YDD-450/1000/1800 (excluding cryoboxes)
	Plastic cryo box	FH-25	FH-25	Used for storing 1.8ml/2ml vial (25 holes)
	Plastic cryo box	FH-81	FH-81	Used for storing 1.8ml/2ml vial (81 holes)
	Plastic cryo box	FH-100	FH-100	Used for storing 1.8ml/2ml vial (interally threaded, 100 holes)
	Cryosmart level monitoring system	ITC-800N-201	ITC-800N-201	Suitable for all capacitive measurement of gas phase liquid nitrogen containers, including the liquid inlet system and excluding the wireless data transmission module

## Product List

Model	Product	Product Model	Factory Code	Description and Accessories
YDD-550-445/PM (27K)	Biobank freezer (smart type)	YDD-550-445/PM	YDD-550-445/PM-K82J2H	Includes vacuum isolated hose (GRG-DN10/2.0), 12pcs of 10-tier rack (5*5), 24 pcs of 10-tier rack (9*9), 120pcs of cryo boxes for 2ml vial (5*5), 240pcs of cryo boxes for 2ml vial (9*9), 1 set of cryosmart (level monitoring system)
	Biobank freezer	YDD-550-445/PM	YDD-550-445/PM-W	Includes vacuum isolated hose (GRG-DN10/2.0), Rack and intelligent level monitoring system are optional
	Rack (vertical type)	FDCJ-25-10	FDCJ-25-10	Used for storing 5*5 cryoboxes (2ml), ten layers in total, suitable for YDD-350/550/1300 (excluding cryoboxes)
	Rack (vertical type)	FDCJ-81-10	FDCJ-81-10	Used for storing 9*9 cryoboxes (2ml), Ten layers in total, Suitable for YDD-350/550/1300 (excluding cryoboxes)
	Plastic cryo box	FH-25	FH-25	Used for storing 1.8ml/2ml vial (25 holes)
	Plastic cryo box	FH-81	FH-81	Used for storing 1.8ml/2ml vial (81 holes)
	Plastic cryo box	FH-100	FH-100	Used for storing 1.8ml/2ml vial (interally threaded, 100 holes)
	Cryosmart level monitoring system	ITC-800N-201	ITC-800N-201	Suitable for all capacitive measurement of gas phase liquid nitrogen containers, including the liquid inlet system and excluding the wireless data transmission module
YDD-750-445/PM (38K)	Biobank freezer (smart type)	YDD-750-445/PM	YDD-750-445/PM-K82J2H	Includes vacuum isolated hose (GRG-DN10/2.0), 12pcs of 14-tier rack (5*5), 24 pcs of 14-tier rack (9*9), 168pcs of cryo boxes for 2ml vial (5*5), 336pcs of cryo boxes for 2ml vial (9*9), 1 set of cryosmart (level monitoring system)
	Biobank freezer	YDD-750-445/PM	YDD-750-445/PM-W	Includes vacuum isolated hose (GRG-DN10/2.0), Rack and intelligent level monitoring system are optional
	Rack (vertical type)	FDCJ-25-14	FDCJ-25-14	Used for storing 5*5 cryoboxes (2ml), Fourteen layers in total, suitable for YDD-450/750 (excluding cryoboxes)
	Rack (vertical type)	FDCJ-81-14	FDCJ-81-14	Used for storing 9*9 cryoboxes (2ml), Fourteen layers in total, suitable for YDD-450/750 (excluding cryoboxes)
	Plastic cryo box	FH-25	FH-25	Used for storing 1.8ml/2ml vial (25 holes)
	Plastic cryo box	FH-81	FH-81	Used for storing 1.8ml/2ml vial (81 holes)
	Plastic cryo box	FH-100	FH-100	Used for storing 1.8ml/2ml vial (interally threaded, 100 holes)
	Cryosmart level monitoring system	ITC-800N-201	ITC-800N-201	Suitable for all capacitive measurement of gas phase liquid nitrogen containers, including the liquid inlet system and excluding the wireless data transmission module
YDD-850-465/PM (43K)	Biobank freezer (Smart type)	YDD-850-465/PM	YDD-850-465/PM-K82J2H	Includes vacuum isolated hose (GRG-DN10/2.0), 4 pcs of 13-tier rack (5*5), 32 pcs of 13-tier rack (9*9), 52pcs of cryo boxes (5*5) for 2ml vial, 416pcs of cryo boxes (9*9) for 2ml vial, 1 set of cryosmart (level monitoring system)
	Biobank freezer	YDD-850-465/PM	YDD-850-465/PM-W	Includes vacuum isolated hose (GRG-DN10/2.0), Rack and intelligent level monitoring system are optional
	Rack (vertical type)	FDCJ-25-13	FDCJ-25-13	Used for storing 5*5 cryoboxes (2ml), Thirteen layers in total, suitable for YDD-850/1600 (excluding cryoboxes)
	Rack (vertical type)	FDCJ-81-13	FDCJ-81-13	Used for storing 9*9 cryoboxes (2ml), Thirteen layers in total, suitable for YDD-850/1600 (excluding cryoboxes)
	Plastic cryo box	FH-25	FH-25	Used for storing 1.8ml/2ml vial (25 holes)
	Plastic cryo box	FH-81	FH-81	Used for storing 1.8ml/2ml vial (81 holes)
	Plastic cryo box	FH-100	FH-100	Used for storing 1.8ml/2ml vial (interally threaded, 100 holes)
	Cryosmart level monitoring system	ITC-800N-201	ITC-800N-201	Suitable for all capacitive measurement of gas phase liquid nitrogen containers, including the liquid inlet system and excluding the wireless data transmission module

# Biobank Series for Large Scale Storage

407/408

## Product List

Model	Product	Product Model	Factory Code	Description and Accessories
YDD-1000-465/PT (51K)	Biobank freezer (Smart type)	YDD-1000-465/PT	YDD-1000-465/PT-K82J2H	Includes vacuum isolated hose (GRG-DN10/2.0), 16 pcs of 15-tier rack (5*5), 30 pcs of 15-tier rack (9*9), 240pcs of cryo boxes (5*5) for 2ml vial, 450pcs of cryo boxes (9*9) for 2ml vial, 1 set of cryosmart (level monitoring system)
	Biobank freezer	YDD-1000-465/PT	YDD-1000-465/PT-W	Includes vacuum isolated hose (GRG-DN10/2.0), Rack and intelligent level monitoring system are optional
	Rack (vertical type)	FDCJ-25-15	FDCJ-25-15	Used for storing 5*5 cryoboxes (2ml), Fifteen layers in total, suitable for YDD-450/1000/1800 (excluding cryoboxes)
	Rack (vertical type)	FDCJ-81-15	FDCJ-81-15	Used for storing 9*9 cryoboxes (2ml), Fifteen layers in total, suitable for YDD-450/1000/1800 (excluding cryoboxes)
	Plastic cryo box	FH-25	FH-25	Used for storing 1.8ml/2ml vial (25 holes)
	Plastic cryo box	FH-81	FH-81	Used for storing 1.8ml/2ml vial (81 holes)
	Plastic cryo box	FH-100	FH-100	Used for storing 1.8ml/2ml vial (interally threaded, 100 holes)
	Cryosmart level monitoring system	ITC-800N-201	ITC-800N-201	Suitable for all capacitive measurement of gas phase liquid nitrogen containers, including the liquid inlet system and excluding the wireless data transmission module
	YDD-1300-635/PM (59K)	Biobank freezer (Smart type)	YDD-1300-635/PM	YDD-1300-635/PM-K82J2H
Biobank freezer		YDD-1300-635/PM	YDD-1300-635/PM-W	Includes vacuum isolated hose (GRG-DN10/2.0), Rack and intelligent level monitoring system are optional
Rack (vertical type)		FDCJ-25-10	FDCJ-25-10	Used for storing 5*5 cryoboxes (2ml), ten layers in total, suitable for YDD-350/550/1300 (excluding cryoboxes)
Rack (vertical type)		FDCJ-81-10	FDCJ-81-10	Used for storing 9*9 cryoboxes (2ml), Ten layers in total, Suitable for YDD-350/550/1300 (excluding cryoboxes)
Plastic cryo box		FH-25	FH-25	Used for storing 1.8ml/2ml vial (25 holes)
Plastic cryo box		FH-81	FH-81	Used for storing 1.8ml/2ml vial (81 holes)
Plastic cryo box		FH-100	FH-100	Used for storing 1.8ml/2ml vial (interally threaded, 100 holes)
Cryosmart level monitoring system		ITC-800N-201	ITC-800N-201	Suitable for all capacitive measurement of gas phase liquid nitrogen containers, including the liquid inlet system and excluding the wireless data transmission module
YDD-1600-635/PM (76K)		Biobank freezer (Smart type)	YDD-1600-635/PM	YDD-1600-635/PM-K82J2H
	Biobank freezer	YDD-1600-635/PM	YDD-1600-635/PM-W	Includes vacuum isolated hose (GRG-DN10/2.0), Rack and intelligent level monitoring system are optional
	Rack (vertical type)	FDCJ-25-13	FDCJ-25-13	Used for storing 5*5 cryoboxes (2ml), Thirteen layers in total, suitable for YDD-850/1600 (excluding cryoboxes)
	Rack (vertical type)	FDCJ-81-13	FDCJ-81-13	Used for storing 9*9 cryoboxes (2ml), Thirteen layers in total, suitable for YDD-850/1600 (excluding cryoboxes)
	Plastic cryo box	FH-25	FH-25	Used for storing 1.8ml/2ml vial (25 holes)
	Plastic cryo box	FH-81	FH-81	Used for storing 1.8ml/2ml vial (81 holes)
	Plastic cryo box	FH-100	FH-100	Used for storing 1.8ml/2ml vial (interally threaded, 100 holes)
	Cryosmart level monitoring system	ITC-800N-201	ITC-800N-201	Suitable for all capacitive measurement of gas phase liquid nitrogen containers, including the liquid inlet system and excluding the wireless data transmission module

## Product List

Model	Product	Product Model	Factory Code	Description and Accessories
YDD-1800-635/PT (95K)	Biobank freezer (Smart type)	YDD-1800-635/PT	YDD-1800-635/PT-K82J2H	Includes vacuum isolated hose (GRG-DN10/2.0), 13 pcs of 15-tier rack (5*5), 60 pcs of 15-tier rack (9*9), 195pcs of cryo boxes (5*5) for 2ml vial, 900pcs of cryo boxes (9*9) for 2ml vial, 1 set of cryosmart (level monitoring system)
	Biobank freezer	YDD-1800-635/PT	YDD-1800-635/PT-W	Includes vacuum isolated hose (GRG-DN10/2.0), Rack and intelligent level monitoring system are optional
	Rack (vertical type)	FDCJ-25-15	FDCJ-25-15	Used for storing 5*5 cryoboxes (2ml), Fifteen layers in total, suitable for YDD-450/1000/1800 (excluding cryoboxes)
	Rack (vertical type)	FDCJ-81-15	FDCJ-81-15	Used for storing 9*9 cryoboxes (2ml), Fifteen layers in total, suitable for YDD-450/1000/1800 (excluding cryoboxes)
	Plastic cryo box	FH-25	FH-25	Used for storing 1.8ml/2ml vial (25 holes)
	Plastic cryo box	FH-81	FH-81	Used for storing 1.8ml/2ml vial (81 holes)
	Plastic cryo box	FH-100	FH-100	Used for storing 1.8ml/2ml vial (interally threaded, 100 holes)
	Cryosmart level monitoring system	ITC-800N-201	ITC-800N-201	Suitable for all capacitive measurement of gas phase liquid nitrogen containers, including the liquid inlet system and excluding the wireless data transmission module
Other Racks	Blood bag frame	DCJ-250-3H	DCJ-250-3H	3 layers frame used for storing 250ml blood bag, each layer storing one blood bag, with blood bag cassettes included. Suitable for YDD-350/550/1300
	Blood bag frame	DCJ-250-4H	DCJ-250-4H	4 layers frame used for storing 250ml blood bag, each layer storing one blood bag, with blood bag cassettes included. Suitable for YDD-850
	Blood bag frame	DCJ-250-5H	DCJ-250-5H	5 layers frame used for storing 250ml blood bag, each layer storing one blood bag, with blood bag cassettes included. Suitable for YDD-450/750/1000/1800
	Blood bag frame	DCJ-25-6H	DCJ-25-6H	6 layers frame used for storing 25ml blood bag, each layer storing one blood bag, with blood bag cassettes included. suitable for YDD-350/550/1300
	Blood bag frame	DCJ-25-7H	DCJ-25-7H	7 layers frame used for storing 25ml blood bag, each layer storing one blood bag, with blood bag cassettes included. suitable for YDD-850/1600
	Blood bag frame	DCJ-25-8H	DCJ-25-8H	8 layers frame used for storing 25ml blood bag, each layer storing one blood bag, with blood bag cassettes included. suitable for YDD-450/750
	Blood bag frame	DCJ-25-9H	DCJ-25-9H	9 layers frame used for storing 25ml blood bag, each layer storing one blood bag, with blood bag cassettes included. suitable for YDD-1000/1800
	Blood bag frame	DCJ-50-6H	DCJ-50-6H	6 layers frame used for storing 50ml blood bag, each layer storing one blood bag, with blood bag cassettes included. suitable for YDD-350/550/1300
	Blood bag frame	DCJ-50-7H	DCJ-50-7H	7 layers frame used for storing 50ml blood bag, each layer storing one blood bag, with blood bag cassettes included. suitable for YDD-850/1600
	Blood bag frame	DCJ-50-8H	DCJ-50-8H	8 layers frame used for storing 50ml blood bag, each layer storing one blood bag, with blood bag cassettes included. suitable for YDD-450/750
	Blood bag frame	DCJ-50-9H	DCJ-50-9H	9 layers frame used for storing 50ml blood bag, each layer storing one blood bag, with blood bag cassettes included. suitable for YDD-1000/1800
	Rack (vertical type)	FDCJ-25-5/5.0	FDCJ-25-5/5.0	Used for storing 5*5 cryoboxes (5ml), five layers in total, suitable for YDD-350/550/1300 (excluding cryoboxes)
	Rack (vertical type)	FDCJ-25-7/5.0	FDCJ-25-7/5.0	Used for storing 5*5 cryoboxes (5ml), seven layers in total, suitable for YDD-450/750/850/1600 (excluding cryoboxes)
	Rack (vertical type)	FDCJ-25-9/5.0	FDCJ-25-9/5.0	Used for storing 5*5 cryoboxes (5ml), nine layers in total, suitable for YDD-1000/1800 (excluding cryoboxes)
	Rack (vertical type)	FDCJ-81-5/5.0	FDCJ-81-5/5.0	Used for storing 9*9 cryoboxes (5ml), Five layers in total, suitable for YDD-350/550 (excluding cryoboxes)
	Rack (vertical type)	FDCJ-81-6/5.0	FDCJ-81-6/5.0	Used for storing 9*9 cryo boxes (5ml), 7 layers in total, suitable for YDD-370/1300 (excluding cryoboxes)
	Rack (vertical type)	FDCJ-81-7/5.0	FDCJ-81-7/5.0	Used for storing 9*9 cryoboxes (5ml), Seven layers in total, suitable for YDD-850/1600 (excluding cryoboxes)
	Rack (vertical type)	FDCJ-81-9/5.0	FDCJ-81-9/5.0	Used for storing 9*9 cryoboxes (5ml), nine layers in total, suitable for YDD-450/750/1000/1800 (excluding cryoboxes)
	Rack (vertical type)	XDCJ-8-12	XDCJ-8-12	Used for storing 8 holes aluminium cryoboxes (2ml), Twelve layers in total, with aluminium cryoboxes included. suitable for YDD-450/750/850/1600
	Rack (vertical type)	XDCJ-8-9	XDCJ-8-9	Used for storing 8 holes aluminium cryoboxes (2ml), Nine layers in total, with aluminium cryoboxes included. suitable for YDD-350/550/1300
Round Rack	YDCJ-97-2	YDCJ-97-2	With 2 stainless steel canisters ( 97/276mm), 4 plastic goblets SNT-97 and 2 pick up lifter for goblets in total, the storage capacity for 0.5ml straw is 3016, suitable for YDD-350\YDD-550\YDD-1300	



# CryoBio Biobank Series Liquid Nitrogen Container

409/410

*Innovative design with advanced CryoSmart Pro control system for optimal sample security. It is ideal storage equipment for storing cord blood, tissue cells, biomaterials and so on to keep the activity of cell samples.*



CryoBio 13

CryoBio 43

**•Ten-inch LCD touch screen**

10-inch LCD touch screen, easy to operate. The storage life of charts and digital data records is up to 5 years.

**•Safe and secure**

Cryosmart Level Monitoring System ZJY-800N Pro, which supports fingerprint and NFC access, providing multiple safeguards for sample safety.

**•Innovative frost-free design**

Unique exhaust structure to avoid frost on the neck. Brand-new drainage structure to avoid internal water accumulation.

**•Auto-fill function**

Manual and automatic liquid nitrogen filling modes available. With hot gas bypass function, the unit effectively reduces the temperature fluctuation in the tank when liquid nitrogen is filled, improving sample security.

**Ergonomic Design**

**Designed for both liquid and vapor phase storages**

Vapour phase storage can reach -190°C

**Real-time run monitoring for sample protection**

Real-time level, temperature monitoring  
Remote alarm can also be made through APP, SMS, email, etc

**User-friendly design**

Universal casters, easy to move, and equipped with brakes  
The newly designed one-button pedal (CryoBio 43) and hydraulic opening cover makes it easier to pick and place samples



**Product Parameters**

Model	2ml Vials (Internal Thread)	Freeze Rack (100 Wells)	Freeze Rack (25 Wells)	Layers of Each Rack	5ml Vials (Internal Thread)	Freeze Rack (81 Wells)	Freeze Rack (25 Wells)	Layers of Each Rack	Volume of LN <sub>2</sub> (L)
CryoBio 13	13000	12	4	10	5360	12	4	5	350
Volume of LN <sub>2</sub> Under the tray (L)	Operating Height (mm)	Usable Internal Height (mm)	Inside Neck Diameter (mm)	Height (mm)	Outside Diameter (mm)	Door Width Requirements (mm)	Empty Weight (kg)	Full Weight (kg)	
55	990	600	326	1505	910	930	269	552	

Model	1.2ml/ 1.8ml/2ml Vials (Internal Thread)	Freeze Rack (100 Wells)	Freeze Rack (25 Wells)	Layers of Each Rack	Volume of LN <sub>2</sub> (L)	Volume of LN <sub>2</sub> Under the Tray (L)	
CryoBio 43	42900	32	4	13	890	135	
Operating Height (mm)	Usable Internal Height (mm)	Inside Neck Diameter (mm)	Height (mm)	Outside Diameter (mm)	Empty Weight (kg)	Full Weight (kg)	Door Width Requirements (mm)
1000	773	465	1810	1240	471	1190	1260

**Blood Bag Capacity**

Model	CryoBio 13			CryoBio 43		
	Bag Specifications	Total No. of Bags	Rack Layers	No. of Racks	Total No. of Bags	Rack Layers
25ml (791 OS/U)	1176	6	196	2944	8	368
50ml (4R9951)	720	6	120	1856	8	232
250ml (4R9953)	264	3	88	860	5	172
500ml (DF-200)	168	3	56	560	5	112
500ml (4R9955)	144	3	48	480	5	96
700ml (DF - 700)	96	3	3	272	4	68

**Product List**

Model	Product	Product Model	Factory code	Description and Accessories
CryoBio 13 (13k)	Biobank Freezer (Smart type)	CryoBio 13	CryoBio 13-J2H	Includes vacuum isolated hose (GRG-DN10/2.0), 4 pcs of 10-tier rack (5*5), 12 pcs of 10-tier rack (9*9), 40pcs of cryo boxes (5*5) for 2ml vial, 120pcs of cryo boxes (9*9) for 2ml vial, 1 set of cryosmart (level monitoring system)
	Biobank freezer	CryoBio 13	CryoBio 13-W	Includes vacuum isolated hose (GRG-DN10/2.0) and 1 set of cryosmart (level monitoring system)
	Rack (vertical type)	FDCJ-25-10	FDCJ-25-10	Used for storing 5*5 cryoboxes (2ml), ten layers in total, suitable for YDD-350/550/1300 (excluding cryoboxes)
	Rack (vertical type)	FDCJ-81-10	FDCJ-81-10	Used for storing 9*9 cryoboxes (2ml), ten layers in total, suitable for YDD-350/550/1300 (excluding cryoboxes)
	Plastic cryo box	FH-25	FH-25	Used for storing 1.8ml/2ml vial (25 holes)
	Plastic cryo box	FH-81	FH-81	Used for storing 1.8ml/2ml vial (81 holes)
CryoBio 43 (43k)	Biobank Freezer (Smart type)	CryoBio 43	CryoBio 43-J2H	Includes vacuum isolated hose (GRG-DN10/2.0), 4 pcs of 12-tier rack (5*5), 32 pcs of 12-tier rack (9*9), 52pcs of cryo boxes (5*5) for 2ml vial, 416pcs of cryo boxes (9*9) for 2ml vial, 1 set of cryosmart (level monitoring system)
	Biobank Freezer	CryoBio 43	CryoBio 43-W	Includes vacuum isolated hose (GRG-DN10/2.0), 1 set of cryosmart (level monitoring system)
	Rack (vertical type)	FDCJ-25-13	FDCJ-25-13	Used for storing 5*5 cryoboxes (2ml), Thirteen layers in total, suitable for YDD-850/1600 (excluding cryoboxes)
	Rack (vertical type)	FDCJ-81-13	FDCJ-81-13	Used for storing 9*9 cryoboxes (2ml), Thirteen layers in total, suitable for YDD-850/1600 (excluding cryoboxes)
	Plastic cryo box	FH-25	FH-25	Used for storing 1.8ml/2ml vial (25 holes)
	Plastic cryo box	FH-81	FH-81	Used for storing 1.8ml/2ml vial (81 holes)
	Plastic cryo box	FH-100	FH-100	Used for storing 1.8ml/2ml vial (internally threaded, 100 holes)

# CryoStation Mobile Vapour Storage Trolley

411/412

The unit can be used to preserve plasma and biomaterials during transportation. It is suitable for deep hypothermia operation and transportation of samples in hospitals, various biobanks and laboratories. High quality stainless steel in combination with the thermal insulation layer ensures the effectiveness and durability of the low temperature transport trolley.



YDC-3000H

## Product Advantages

### Touch Screen

LCD touch operation



### USB Data Export

It has its own USB interface and supports USB data export.



### Real Time Monitoring

The instrument monitors the temperature and liquid level in real time and displays the expected remaining service time. Continuous working hours up to 24 hours.



## User Friendly Design



**Durable Construction**  
Ideal for the laboratory environment, stain-resistant.



**Caster Design**  
Integrated design, universal caster at the bottom, easy to move.



**Polymer Materials**  
The new type of environmentally-friendly polymer material is used inside the cover plate, which is more appealing, more environment-friendly and more advanced than the commonly used pearl foam and polyurethane materials.



**Magnetic Lid**  
Convenient lid storage solution by the use of magnets. Adheres to side when not in use.

## Technical Parameters

Product Model	Dimensions (L*W*H)(mm)	Frozen Storage Space (L*W*H)(mm)	Shelf Space (L*W*H)(mm)	Liquid Nitrogen Under Tray (L)	Empty Weight (kg)	Maximum Storage				
						5*5 Freezing Boxes (ea)	10*10 Freezing Boxes (ea)	50ml Blood Bag Boxes (ea)	200ml Blood Bag Boxes (ea)	2ml Cryopreservation Tube (ea)
YDC-3000H	1295*523*1095	960*335*163	950*440*220	33	150	65	30	105	50	3000



# Bio-2T Cryovial Transfer Flask

*Bio-2T is suitable for short-distance sample transportation in small batches in experimental units or hospitals. Lightweight, portable design, easy to take*

**•Lightweight design**

Lightweight design of the product, the total empty weight is only 3kg

**•Temperature display**

Visual real-time temperature monitoring, and the instrument part is dustproof and waterproof

**•Multi-specification compatibility**

Compatible with 1.2m, 1.5m, 1.8m, 2.0m and 5.0ml sample storage tubes

**•High thermal insulation performance**

Vacuum structure, thickened thermal insulation material, ensuring the working temperature in the tank -135°C--196°C, and ultra-long low-temperature storage period



## Ergonomic Design

### Condensate water inflow prevention structure

The specially designed upper cover can prevent condensate from flowing into the container and ensure the container cover to open smoothly.



### Liquid nitrogen splash prevention structure

Ensure that liquid nitrogen is not sprayed during transportation after the container is filled with liquid nitrogen, and it is safe to use.



### No liquid nitrogen overflow

It is specially equipped with liquid nitrogen adsorption layer, and under special circumstances, the container pours liquid nitrogen out, which can also ensure the low temperature environment in a certain period of time and ensure the safety of samples.



## Product Parameters

O.D. (mm)	I.D. (mm)	Depth (mm)	Height (mm)	Total Empty Weight of Tank (Kg)	Liquid Nitrogen Volume (L)	Storage Time of Liquid Phase (h)	Storage Time of Gas Phase (h)	Internal Freezing Tube Capacity (2ml)(pcs)	Working Temperature (°C)	Working Environment (°C)
156	125	190	1100	3	2	8	6	54	-135--196	20-40



*BioT Air is suitable for small batch and short distance sample transportation in experimental units or hospitals. Lightweight, portable design, easy to take.*

#### •Lightweight design

Lightweight design, the total empty weight is only 2.8KG.

#### •Variety of sample storage options

Compatible with 1.2ml, 1.5ml, 1.8ml, 2.0ml and 5.0ml sample cryopreservation tubes, and can also hold a 5\*5-2ML cryopreservation box.

#### •High thermal insulation performance

Vacuum structure ensures the working temperature in the tank-135°C--196°C, and the ultra-long low-temperature storage period.

#### •No liquid nitrogen overflow

There is a liquid nitrogen adsorption layer at the bottom, and even if the container is tipped over, there will be no liquid nitrogen overflow, thus ensuring the safety of samples and personnel.



## Ergonomic Design

### Condensate water inflow prevention structure

The specially designed upper cover can prevent condensate from flowing into the container and ensure the container cover to opens smoothly.



### Liquid nitrogen splash prevention structure

Ensures the liquid nitrogen will be contained during transportation.



### Ultra-low temperature adsorption function

With liquid nitrogen adsorption layer at the bottom, even if the container falls down during dry storage, there will be no liquid nitrogen overflow, which ensures the safety of samples and personnel.



## Product Parameters

O.D. (mm)	I.D. (mm)	Depth (mm)	Height (mm)	Total Empty Weight of Tank (Kg)	Liquid Nitrogen Volume (L)	Storage Time of Liquid Phase (h)	Storage Time of Gas Phase (h)	Internal Freezing Tube Capacity (2ml)(pcs)	Working Temperature (°C)	Working Environment (°C)
156	125	190	235	2.8	2	8	6	55	-135--196	-20-40

# Intelligent Liquid Nitrogen Biological Container

Get total ease of access with Haier Biomedical's wide neck container with integral control and monitoring system, suitable for cryogenic storage of samples, plasma, cell tissue samples and other materials.

### •Easier access

With the full opening hydraulic lid design, users can access and remove their samples with ease.

### •Brand new intelligent monitoring system

It's equipped with the brand-new intelligent monitoring system and matched with our IoT module which can connect with Haier's big data cloud platform. Integrating three screens, it can alert alarm status via the APP, email or our website enabled devices.

With USB interface, it supports data export.

With larger battery capacity, it can still be used after power failure.

### •Reduce frosting and freezing

The brand-new cover and interlayer exhaust structure can effectively reduce the frosting and freezing at exhaust port.

### •Sleek, modern and ergonomic design

With fully integrated touchscreen LCD controller, conveniently positioned to avoid the affects of cryogenic temperatures when opening the cabinet.

Bottom caster, easy to move, with adjustable back brake, easy to fix and stabilize.



## Product Parameters

417/418

Model	CryoBio 11Z		CryoBio 20Z		CryoBio 34Z	
	Vapor Phase	Liquid Phase	Vapor Phase	Liquid Phase	Vapor Phase	Liquid Phase
1.2ml, 1.8ml, 2ml Vials (Internal Thread)	11000	13000	20350	24050	33550	42900
5*5Rack (vertical type)	-	-	10	10	10	8
10*10Rack (vertical type)	10	10	16	16	28	31
5*5Freezer Box	-	-	110	130	110	104
10*10Freezer Box	110	130	176	208	308	403
Layers of Vertical Type Rack	11	13	11	13	11	13
Volume of LN (L)	200		340		550	
Exterior Dimensions (W*D*H)(mm)	1035*730*1190		1170*910*1190		1410*1100*1190	
Usable Internal Height (mm)	790		790		790	
Static Evaporation (L/Day)	7		10		12	
Empty Weight (kg)	209		301.5		400	
Inside Neck Diameter (mm)	610		790		1000	
Full Weight (kg)	357		543		821	

## Product List

Model	Product	Product Model	Factory Code	Description and Accessories
CryoBio 11Z (11K)	Zhiling Liquid Nitrogen Container (Smart type)	CryoBio 11Z	CryoBio 11Z-J2H	Includes vacuum isolated hose (GRG-DN10/2.0), 1 set of cryosmart (level monitoring system), 10pcs of 11-tier rack (9*9), 110pcs of cryo boxes (9*9) for 2ml vial
	Zhiling Liquid Nitrogen Container	CryoBio 11Z	CryoBio 11Z-W	Includes vacuum isolated hose (GRG-DN10/2.0) and intelligent monitoring system, rack is optional
	Rack (vertical type)	FDCJ-81-11	FDCJ-81-11	Used for storing 9*9 cryoboxes (2ml), eleven layers in total, suitable for CryoBio 11Z/CryoBio 20Z/CryoBio 34Z (excluding cryoboxes)
	Plastic cryo box	FH-81	FH-81	Used for storing 1.8ml/2ml vial (81 holes)
	Plastic cryo box	FH-100	FH-100	Used for storing 1.8ml/2ml vial (interally threaded, 100 holes)
CryoBio 20Z (20K)	Zhiling Liquid Nitrogen Container (Smart type)	CryoBio 20Z	CryoBio 20Z-J2H	Includes vacuum isolated hose (GRG-DN10/2.0), 1 set of cryosmart (level monitoring system), 10 pcs of 11-tier rack (5*5), 16pcs of 11-tier rack (9*9), 110pcs of cryo boxes (5*5) for 2ml vial, 176pcs of cryo boxes (9*9) for 2ml vial
	Zhiling Liquid Nitrogen Container	CryoBio 20Z	CryoBio 20Z-W	Includes vacuum isolated hose (GRG-DN10/2.0) and intelligent monitoring system, rack is optional
	Rack (vertical type)	FDCJ-25-11	FDCJ-25-11	Used for storing 5*5 cryoboxes (2ml), eleven layers in total, suitable for CryoBio 11Z/CryoBio 20Z/CryoBio 34Z (excluding cryoboxes)
	Rack (vertical type)	FDCJ-81-11	FDCJ-81-11	Used for storing 9*9 cryoboxes (2ml), eleven layers in total, suitable for CryoBio 11Z/CryoBio 20Z/CryoBio 34Z (excluding cryoboxes)
	Plastic cryo box	FH-25	FH-25	Used for storing 1.8ml/2ml vial (25 holes)
	Plastic cryo box	FH-81	FH-81	Used for storing 1.8ml/2ml vial (81 holes)
CryoBio 34Z (34K)	Zhiling Liquid Nitrogen Container	CryoBio 34Z	CryoBio 34Z-J2H	Includes vacuum isolated hose (GRG-DN10/2.0), 1 set of cryosmart (level monitoring system), 10 pcs of 11-tier rack (5*5), 28pcs of 11-tier rack (9*9), 110pcs of cryo boxes (5*5) for 2ml vial, 308pcs of cryo boxes (9*9) for 2ml vial
	Zhiling Liquid Nitrogen Container (Smart type)	CryoBio 34Z	CryoBio 34Z-W	Includes vacuum isolated hose (GRG-DN10/2.0) and intelligent monitoring system, Rack is optional
	Rack (vertical type)	FDCJ-25-11	FDCJ-25-11	Used for storing 5*5 cryoboxes (2ml), eleven layers in total, suitable for CryoBio 11Z/CryoBio 20Z/CryoBio 34Z (excluding cryoboxes)
	Rack (vertical type)	FDCJ-81-11	FDCJ-81-11	Used for storing 9*9 cryoboxes (2ml), Eleven layers in total, suitable for CryoBio 11Z/CryoBio 20Z/CryoBio 34Z (excluding cryoboxes)
	Plastic cryo box	FH-25	FH-25	Used for storing 1.8ml/2ml vial (25 holes)
Plastic cryo box	FH-81	FH-81	Used for storing 1.8ml/2ml vial (81 holes)	
Plastic cryo box	FH-100	FH-100	Used for storing 1.8ml/2ml vial (interally threaded, 100 holes)	

## Blood Bag Capacity

Model	Cryobio 11Z			Cryobio 20Z			Cryobio 34Z			
	Total No. of Bags	Rack Layers	No. of Racks	Total No. of Bags	Rack Layers	No. of Racks	Total No. of Bags	Rack Layers	No. of Racks	
Gas Phase	25ml	864	6	144	1500	6	250	2412	6	402
	50ml	528	6	88	924	6	154	1512	6	252
	250ml	272	4	68	480	4	120	808	4	202
Liquid Phase	25ml	1152	8	144	2000	8	250	3216	8	402
	50ml	704	8	88	1232	8	154	2016	8	252
	250ml	340	5	68	600	5	120	1010	5	202



## CryoBio 6S Liquid Nitrogen Container with Autorefill

419/420

*This storage vessel minimises the need for and risks associated with manual filling. Applications include the storage of cord blood, stem cells, car-T cells, tissues and other biomaterials within academia, pharma and clinical labs. Stores up to 6,000 2ml cryovials (internally-threaded).*

### •Auto fill design

The autofill function can eliminate the need for manual filling and associated health safety risks.

### •Accurate real-time monitoring

Equipped with a brand-new intelligent monitor, it detects and records in real-time both temperature and liquid level, and automatically saves data, including re-fill and alarm notifications for up to 5 years.

### •Low liquid nitrogen consumption 1.5L/day

Advanced vacuum and heat preservation technologies ensure an industry-leading low consumption of liquid nitrogen in the container and the stability of temperature in the sample freezing space, to maximize efficiency and reduce operating costs.

The temperature at the top of the freezing rack can reach -190°C, and the average consumption of liquid nitrogen is only 1.5L.



## Ergonomic Design

Designed for both liquid and vapor phase storage

The one-button defogging function makes it easier to find samples

Automatic data saving and USB data (temperature, liquid level, alarm records and other data) export are supported

Sealed centralized exhaust system minimises frost build up

A battery-back up as standard, the controller can function for up to 8 hours without mains power

1 year parts warranty; 5 years vacuum warranty

The multi-lock structure makes the sample storage safer

With hot gas bypass function, reduces the temperature fluctuation in the tank when liquid nitrogen is filled, enhancing sample security

A complete data recording system allows users to check the temperature, liquid level, and alarm records at any time

With multiple alarm functions such as high and low temperature, high and low liquid level, and real-time audio/visual alarms

## Product Parameters

Model	Volume of LN <sub>2</sub> (L)	Inside Neck Diameter (mm)	Height (mm)	Outside Diameter (mm)	Empty Weight (kg)
CryoBio 6S	175	216	1490	681	78

Working Evaporation (L/Day)	Static Evaporation (L/Day)	2ml Vials (Internal Thread)	Square Rack	Layers of Square Rack
1.5	0.95	6000	6	10

## Product List

Model	Product	Product Model	Factory Code	Description and Accessories
CryoBio 6S	Biobank Freezer	CryoBio 6S	CryoBio 6S-J2H	CryoBio 6S tank, includes 6 racks with 10 layers, 9*9 cryoboxes, lockable cap and controller. No Pu bag, 5 wheels roller base, transfer hose GRG-DN10/2.0 and one tier step are also included.
	Biobank Freezer	CryoBio 6S	CryoBio 6S-W	CryoBio 6S tank, with lockable cap and controller, no pu bag, no racks or cryoboxes, 5 wheels roller base, transfer hose GRG-DN10/2.0 and one tier step are included.
	Rack	FTT-81-10H	FTT-81-10H	Used for storing 9*9 cryo boxes (2ml), 10 layers in total, with 9*9 cryo boxes included, suitable for YDS-175-216, CryoBio 6S
	Rack	FTT-81-5/5.0H	FTT-81-5/5.0H	Used for storing 9*9 cryo boxes (5ml), 5 layers in total, with 9*9 cryo boxes included, suitable for YDS-175-216, CryoBio 6S
	Data Repeater	RP-4004G	RP-4004G	Data transmitted to cloud platform through GPRS, with SIM card included, suitable for all YDD products of Haier
	175	One step ladder	175	One tier step, suitable for CryoBio 6S
	Roller Base	YSC-685-5W	YSC-685-5W	Suitable for all 65L-175L aluminium tank, equipped with 5 universal wheels



## Smart Series (Square Racks)

421/422

The smart, IoT and cloud management system monitors temperature and liquid levels simultaneously to provide accurate and real-time information on the critical parameters to ensure ultimate sample safety.

- IoT and Cloud Management
- Multiple Level of Protections
- Low Energy Consumption
- Temperature and Level Display
- Updated Design
- High Performance Stability
- New Lock Design



### Key Features

- 5 models from 2,400 to 6,000 cryovial capacity
- 5 years vacuum warranty
- Durable aluminium construction
- Real time monitor of temperature and level
- Cloud data storage for traceability
- Low consumption rate and high performance stability
- New lock design

### Product Advantages

#### Colour identification for Rack handles

Rack handles are colour-coded for ease of separating storage zones and managing samples.



#### Double lock and double control design

The new double lock and double control design requires two people to open at the same time to ensure sample safety.



#### Dual monitoring respectively for temperature and liquid level

Storage temperature and liquid level are automatically monitored by a high precision controller. Accurate and real-time information ensures samples safety.



#### Multilayer protection for ultimate safety

Temperature and level are monitored in real time to safeguard the storage environment. Alarms can be transmitted through email, IM and wechat.

#### Low consumption rate and high performance stability

Automated manufacture ensures build quality and reliable vacuum which delivers stable and uniform temperature performance as well as low LN<sub>2</sub> consumption rates.



### Accessories

Rack



Roller Base



## Technical Parameters

Model	YDS-65-216	YDS-95-216	YDS-115-216	YDS-145-216	YDS-175-216
<b>Maximum Storage Volume</b>					
No. of Rack	6	6	6	6	6
2ml Storage Vials (100/box)	2400	3000	3600	4800	6000
Layers in Rack	4	5	6	8	10
5ml Storage Vials (81/box)	—	972	1458	1944	2430
Layers in Rack	—	2	3	4	5
<b>Function</b>					
Liquid Nitrogen Volume (L)	65	95	115	145	175
Static Evaporation Rate* (L/D)	0.78	0.94	0.94	0.94	0.95
Static Holding Time** (Day)	83	101	122	154	184
<b>Dimensions</b>					
Neck Opening (mm)	216	216	216	216	216
Overall Height (mm)	760	825	895	995	1110
Overall Diameter (mm)	681	681	681	681	681
Empty Weight (kg)	41	44	48	53	58
Full Weight (kg)	108	121	141	171	199.5
Shipping Weight (kg)	65.5	69.2	75.9	85.2	94.5

\* Static evaporation and static holding time are theoretical values. Actual evaporation and holding time are affected by usage, atmospheric conditions and manufacturing tolerances.

\*\* Static Holding Time: the amount of days it takes for all of the LN to evaporate out after container is filled with liquid nitrogen to pre-cool and reach thermal equilibrium and the liquid nitrogen filling rate reaches 100% under standard atmospheric condition.

## Product List

Model	Product	Product Model	Factory Code	Description and Accessories
YDS-65-216	Smart liquid nitrogen container (smart series)	YDS-65-216	YDS-65-216-FZH	Includes 6 racks (4-tier), cryoboxes (9*9), lockable cap, roller base is optional
YDS-95-216	Smart liquid nitrogen container (smart series)	YDS-95-216	YDS-95-216-FZH	Includes 6 racks (5-tier), cryoboxes (9*9), lockable cap, roller base is optional
YDS-115-216	Smart liquid nitrogen container (smart series)	YDS-115-216	YDS-115-216-FZH	Includes 6 racks (6-tier), cryoboxes (9*9), lockable cap, roller base is optional
YDS-145-216	Smart liquid nitrogen container (smart series)	YDS-145-216	YDS-145-216-FZH	Includes 6 racks (8-tier), cryoboxes (9*9), lockable cap, roller base is optional
YDS-175-216	Smart liquid nitrogen container (smart series)	YDS-175-216	YDS-175-216-FZH	Includes 6 racks (10-tier), cryoboxes (9*9), lockable cap, roller base is optional
	Roller Base	YSC-685-5W	YSC-685-5W	Suitable for all 65L-175L aluminium tank, equipped with 5 universal wheels

Medium Sized Storage Series (Square Racks) features low LN<sub>2</sub> consumption and relatively small footprint for medium capacity sample storage.

- 5 Years Vacuum Warranty
- Durable
- Cryobox Storage
- Secure
- High Thermal Efficiency
- Liquid and Vapour Storage



# Medium Sized Storage Series (Square Racks)

## Key Features

- Heavy duty lockable enclosure offers excellent security
- Compatible with all major cryobox brands
- Durable aluminium construction
- Temperature monitoring available
- Liquid or vapour phase option available
- High thermal efficiency
- 5 year vacuum warranty
- Ultra-low evaporation loss

## Product Advantages

### ULT Storage with Extremely Low LN<sub>2</sub> Evaporation Loss

Freezer racks are in the ultra-low temperature environment with extremely low LN<sub>2</sub> evaporation. Even stored in vapour phase, the temperature will be below -190°C for a long time.

### Advanced Vacuum Technology and Superinsulation Technology

Advanced vacuum and insulation technologies ensure cryopreservation for up to four months.

### Compatible for Blood Bag Storage

Suitable for blood bag applications, the racks can be adapted to provide temporary blood bag storage before transferring bags to larger LN<sub>2</sub> storage tanks.



## Liquid Nitrogen Temperature Detector

The temperature monitor provides continuous and reliable monitoring of the temperature in the container. It is the ideal choice for long-term monitoring of sample storage temperature and reminding users to add liquid nitrogen.

The temperature monitor ZTC-100A has real-time temperature display function, and can also provide the following alarms:

- \* Over temperature alarm
- \* Sensor error acousto-optic alarm



ZTC-100A

## Technical Parameters

Model	YDS-65-216	YDS-95-216	YDS-115-216	YDS-145-216	YDS-175-216
<b>Maximum Storage Capacity</b>					
No. of Rack	6	6	6	6	6
No. 2.0 ml Cryovials (100 / Box)	2400	3000	3600	4800	6000
No. of Boxes in (2ml each Rack)	4	5	6	8	10
No. 5.0 ml Cryovials (81/Box)	972	972	1458	1944	2430
No. of Boxes in (5ml each Rack)	2	2	3	4	5
<b>Performance</b>					
Volume of LN <sub>2</sub> (L)	65	95	115	145	175
Static Evaporation Rate* (L/Day)	0.78	0.94	0.94	0.94	0.95
Static Holding Time** (Day)	83	101	122	154	184
<b>Dimensions</b>					
Neck Opening Diameter (mm)	216	216	216	216	216
Height (mm)	735	800	870	970	1085
Outer Diameter (mm)	681	681	681	681	681
Empty Weight (kg)	40	43	47	52	57
Full Weight (kg)	107	120	140	170	198.5
Shipping Weight (kg)	63.5	67.6	77.6	83.2	92.4

\* Static evaporation and static holding time are theoretical values. Actual evaporation and holding time are affected by usage, atmospheric conditions and manufacturing tolerances.

\*\* Static Holding Time: the amount of days it takes for all of the LN to evaporate out after container is filled with liquid nitrogen to pre-cool and reach thermal equilibrium and the liquid nitrogen filling rate reaches 100% under standard atmospheric condition.

## Accessories





# Medium Sized Storage Series (Square Racks)

427/428

## Product List

Model	Product	Product Model	Factory Code	Description and Accessories
YDS-65-216	Liquid Nitrogen container	YDS-65-216	YDS-65-216-FH	Includes 6 racks(4 layers), 9*9 cryoboxes, lockable cap, no PU bag, roller base is optional
	Liquid Nitrogen container	YDS-65-216	YDS-65-216-W	Includes lockable cap, no rack, no PU bag
	Rack	FTT-81-4H	FTT-81-4H	Used for storing 9*9 cryo boxes(2ml), 4 layers in total, with 9*9 cryo boxes included, suitable for YDS-65-216
	Roller Base	YSC-685-5W	YSC-685-5W	Suitable for all 65L-175L aluminium tank, equipped with 5 universal wheels
	SmartCap	LT-216	LT-216-340-6H530	Used for monitoring real time level and temperature for containers with 216mm neck opening, 6 grooves and 530mm height. suitable for YDS-65-216
	Cork (216)	GS-216-220-7	GS-216-220-7	Suitable for YDS-65-216/YDS-95-216/YDS-115-216/YDS-145-216/YDS-175-216/YDH-15-216/YDH-25-216
YDS-95-216	Lockable cap	SG-216	SG-216	Suitable for container with 216mm neck opening
	Liquid Nitrogen container (5.0ml Vial)	YDS-95-216	YDS-95-216-FH5	Includes 6 racks for 5ml, 2 layers in total, 12pcs of 5ml 9*9 cryo boxes and lockable cap included, no PU bag, roller base is optional
	Liquid Nitrogen container	YDS-95-216	YDS-95-216-FH	Includes 6 racks(5 layers), 9*9 cryoboxes, lockable cap, no PU bag, roller base is optional
	Liquid Nitrogen container	YDS-95-216S	YDS-95-216-W	Includes lockable cap, no rack, no PU bag
	Rack	FTT-81-5H	FTT-81-5H	Used for storing 9*9 cryo boxes(2ml), 5 layers in total, with 9*9 cryo boxes included, suitable for YDS-95-216/YDH-25-216
	Rack	FTT-81-2/5.0H	FTT-81-2/5.0H	Used to store 5ml cryo boxes(9*9), 2 layers in total, 9*9 cryo boxes included, suitable for YDS-65-216/95-216(Plastic cryo boxes included)
YDS-115-216	Roller Base	YSC-685-5W	YSC-685-5W	Suitable for all 65L-175L aluminium tank, equipped with 5 universal wheels
	SmartCap	LT-216	LT-216-370-6H580	Used for monitoring real time level and temperature for containers with 216mm neck opening, 6 grooves and 580mm height. suitable for YDS-95-216
	Cork (216)	GS-216-220-7	GS-216-220-7	Suitable for YDS-65-216/YDS-95-216/YDS-115-216/YDS-145-216/YDS-175-216/YDH-15-216/YDH-25-216
	Lockable cap	SG-216	SG-216	Suitable for container with 216mm neck opening
	Liquid Nitrogen container (5.0ml Vial)	YDS-115-216	YDS-115-216-FH5	Includes 6 racks for 5ml, 3 layers in total, 18pcs of 5ml 9*9 cryo boxes and lockable cap included, no PU bag, roller base is optional
	Liquid Nitrogen container	YDS-115-216	YDS-115-216-FH	Includes 6 racks(6 layers), 9*9 cryoboxes, lockable cap, no PU bag, roller base is optional
YDS-145-216	Liquid Nitrogen container	YDS-115-216	YDS-115-216-W	Includes lockable cap, no rack, no PU bag
	Rack	FTT-81-6H	FTT-81-6H	Used for storing 9*9 cryo boxes(2ml), 6 layers in total, with 9*9 cryo boxes included, suitable for YDS-115-216
	Rack	FTT-81-3/5.0H	FTT-81-3/5.0H	Used for storing 9*9 cryo boxes(5ml), 3 layers in total, with 9*9 cryo boxes included, suitable for YDS-115-216
	Roller Base	YSC-685-5W	YSC-685-5W	Suitable for all 65L-175L aluminium tank, equipped with 5 universal wheels
	SmartCap	LT-216	LT-216-450-6H660	Used for monitoring real time level and temperature for containers with 216mm neck opening, 6 grooves and 660mm height. suitable for YDS-115-216
	Cork (216)	GS-216-220-7	GS-216-220-7	Suitable for YDS-65-216/YDS-95-216/YDS-115-216/YDS-145-216/YDS-175-216/YDH-15-216/YDH-25-216
YDS-175-216	Lockable cap	SG-216	SG-216	Suitable for container with 216mm neck opening
	Liquid Nitrogen container (5.0ml Vial)	YDS-145-216	YDS-145-216-FH5	Includes 6 racks for 5ml, 4 layers in total, 24pcs of 5ml 9*9 cryo boxes and lockable cap included, no PU bag, roller base is optional
	Liquid Nitrogen container	YDS-145-216	YDS-145-216-FH	Includes 6 racks(8 layers), 9*9 cryoboxes, lockable cap, no PU bag, roller base is optional
	Liquid Nitrogen container	YDS-145-216	YDS-145-216-W	Includes lockable cap, no rack, no PU bag
	Rack	FTT-81-8H	FTT-81-8H	Used for storing 9*9 cryo boxes(2ml), 8 layers in total, with 9*9 cryo boxes included, suitable for YDS-145-216
	Rack	FTT-81-4/5.0H	FTT-81-4/5.0H	Used for storing 9*9 cryo boxes(5ml), 4 layers in total, with 9*9 cryo boxes included, suitable for YDS-145-216
Other Racks	Roller Base	YSC-685-5W	YSC-685-5W	Suitable for all 65L-175L aluminium tank, equipped with 5 universal wheels
	SmartCap	LT-216	LT-216-570-6H770	Used for monitoring real time level and temperature for containers with 216mm neck opening, 6 grooves and 770mm height. suitable for YDS-145-216
	Cork (216)	GS-216-220-7	GS-216-220-7	Suitable for YDS-65-216/YDS-95-216/YDS-115-216/YDS-145-216/YDS-175-216/YDH-15-216/YDH-25-216
	Lockable cap	SG-216	SG-216	Suitable for container with 216mm neck opening
	Liquid Nitrogen container (5.0ml Vial)	YDS-175-216	YDS-175-216-FH5	Includes 6 racks for 5ml, 5 layers in total, 30pcs of 5ml 9*9 cryo boxes and lockable cap included, no PU bag, roller base is optional
	Liquid Nitrogen container	YDS-175-216	YDS-175-216-FH	Includes 6 racks(10 layers), 9*9 cryoboxes, lockable cap, no PU bag, roller base is optional
YDS-175-216	Liquid Nitrogen container	YDS-175-216	YDS-175-216-W	Includes lockable cap, no rack, no PU bag
	Rack	FTT-81-10H	FTT-81-10H	Used for storing 9*9 cryo boxes(2ml), 10 layers in total, with 9*9 cryo boxes included, suitable for YDS-175-216/CryoBio 6S
	Rack	FTT-81-5/5.0H	FTT-81-5/5.0H	Used for storing 9*9 cryo boxes(5ml), 5 layers in total, with 9*9 cryo boxes included, suitable for YDS-175-216, CryoBio 6S
	Roller Base	YSC-685-5W	YSC-685-5W	Suitable for all 65L-175L aluminium tank, equipped with 5 universal wheels
	SmartCap	LT-216	LT-216-670-6H870	Used for monitoring real time level and temperature for containers with 216mm neck opening, 6 grooves and 870mm height. suitable for YDS-175-216
	Cork (216)	GS-216-220-7	GS-216-220-7	Suitable for YDS-65-216/YDS-95-216/YDS-115-216/YDS-145-216/YDS-175-216/YDH-15-216/YDH-25-216
Other Racks	Lockable cap	SG-216	SG-216	Suitable for container with 216mm neck opening
	Blood bag rack	XTT-25-2F14/65H	XTT-25-2F14/65H	Used for storing 25ml blood bag, 2 levels in total with each layer storing 14pcs of 25ml blood bag, with 28 cassettes included, suitable for YDS-65-216, 6 racks can be fitted.
	Blood bag rack	XTT-25-2F14/95H	XTT-25-2F14/95H	Used for storing 25ml blood bag, 2 levels in total with each layer storing 14pcs of 25ml blood bag, with 28 cassettes included, suitable for YDS-95-216, 6 racks can be fitted.
	Blood bag rack	XTT-25-3F14/115H	XTT-25-3F14/115H	Used for storing 25ml blood bag, 3 levels in total with each layer storing 14pcs of 25ml blood bag, with 42 cassettes included, suitable for YDS-115-216, 6 racks can be fitted.
	Blood bag rack	XTT-25-4F14/145H	XTT-25-4F14/145H	Used for storing 25ml blood bag, 4 levels in total with each layer storing 14pcs of 25ml blood bag, with 56 cassettes included, suitable for YDS-145-216, 6 racks can be fitted.
	Blood bag rack	XTT-25-5F14/175H	XTT-25-5F14/175H	Used for storing 25ml blood bag, 5 levels in total with each layer storing 14pcs of 25ml blood bag, with 70 cassettes included, suitable for YDS-175-216, 6 racks can be fitted.
	Blood bag rack	XTT-50-1F14/65H	XTT-50-1F14/65H	Used for storing 50ml blood bag, 1 level in total with each layer storing 14pcs of 50ml blood bag, with 14 cassettes included, suitable for YDS-65-216, 6 racks can be fitted.
	Blood bag rack	XTT-50-1F14/95H	XTT-50-1F14/95H	Used for storing 50ml blood bag, 1 level in total with each layer storing 14pcs of 50ml blood bag, with 14 cassettes included, suitable for YDS-95-216, 6 racks can be fitted.
	Blood bag rack	XTT-50-2F14/115H	XTT-50-2F14/115H	Used for storing 50ml blood bag, 2 levels in total with each layer storing 14pcs of 50ml blood bag, with 28 cassettes included, suitable for YDS-115-216, 6 racks can be fitted.
	Blood bag rack	XTT-50-2F14/145H	XTT-50-2F14/145H	Used for storing 50ml blood bag, 2 levels in total with each layer storing 14pcs of 50ml blood bag, with 28 cassettes included, suitable for YDS-145-216, 6 racks can be fitted.
	Blood bag rack	XTT-50-3F14/175H	XTT-50-3F14/175H	Used for storing 50ml blood bag, 3 levels in total with each layer storing 14pcs of 50ml blood bag, with 42 cassettes included, suitable for YDS-175-216, 6 racks can be fitted.
	Blood bag rack	XTT-250-1F8/65H	XTT-250-1F8/65H	Used for storing 250ml blood bag, 1 level in total with each layer storing 8pcs of 250ml blood bag, with 8 cassettes included, suitable for YDS-65-216, 6 racks can be fitted.
	Blood bag rack	XTT-250-1F8/95H	XTT-250-1F8/95H	Used for storing 250ml blood bag, 1 level in total with each layer storing 8pcs of 250ml blood bag, with 8 cassettes included, suitable for YDS-95-216, 6 racks can be fitted.
	Blood bag rack	XTT-250-1F8/115H	XTT-250-1F8/115H	Used for storing 250ml blood bag, 1 level in total with each layer storing 8pcs of 250ml blood bag, with 8 cassettes included, suitable for YDS-115-216, 6 racks can be fitted.
	Blood bag rack	XTT-250-1F8/145H	XTT-250-1F8/145H	Used for storing 250ml blood bag, 1 levels in total with each layer storing 8pcs of 250ml blood bag, with 8 cassettes included, suitable for YDS-145-216, 6 racks can be fitted.
	Blood bag rack	XTT-250-2F8/175H	XTT-250-2F8/175H	Used for storing 250ml blood bag, 2 levels in total with each layer storing 8pcs of 250ml blood bag, with 16 cassettes included, suitable for YDS-145-216, 6 racks can be fitted.

## Product List

## Medium Sized Storage Series (Square Racks)

### Biological Sample Library-YDS Series

#### Storage Example of 2ml Internally Threaded Vial

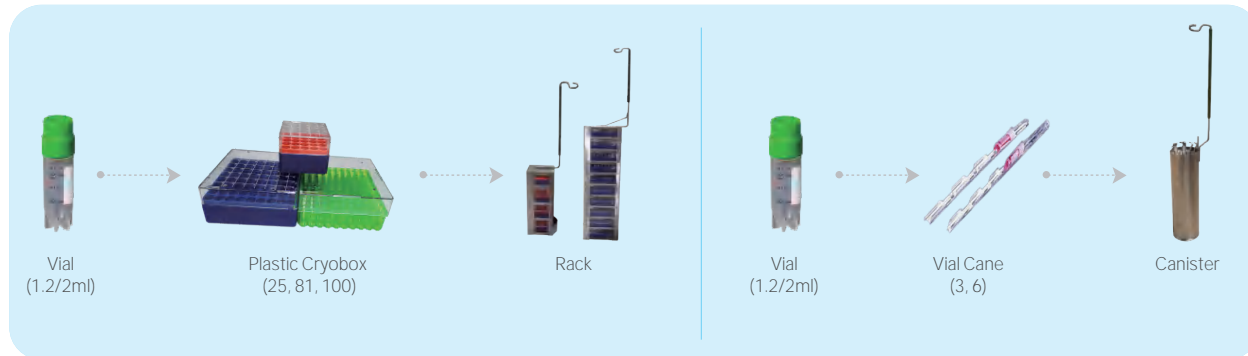

#### Storage Example of Tall 5ml Cryovials

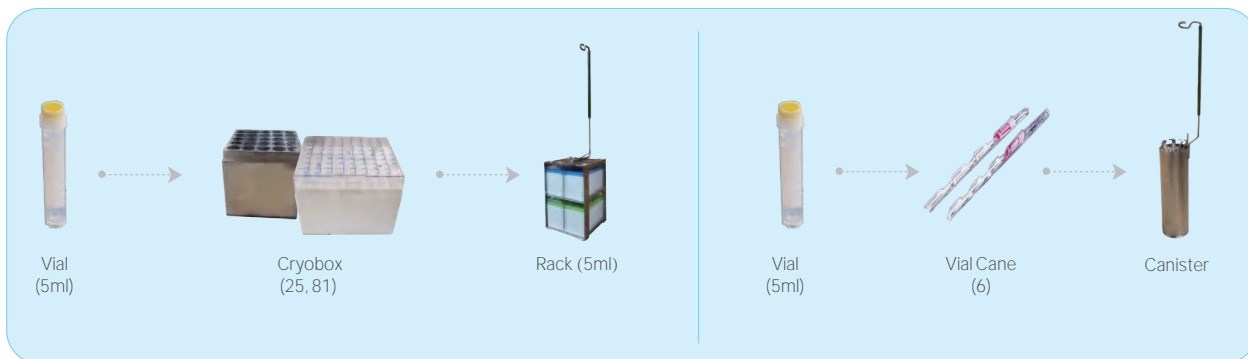

#### Blood Bag Storage Example

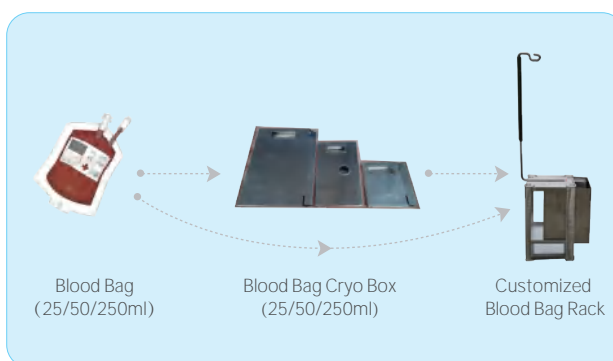

#### Straw Storage Example

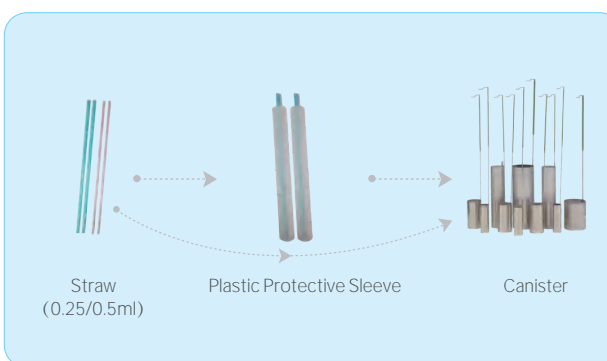

## Small Sized Storage Series (Square Racks)

Widely used within many laboratories, this small-sized storage series features low LN<sub>2</sub> consumption and dual handle design. Stores between 100 and 1100 vials in square racks and cryo boxes.

- 5 Years Vacuum Warranty
- High Thermal Efficiency
- Lightweight
- 10 Litre to 50 Litre Capacity
- Durable
- Secure
- Super-Insulation
- Ideal for Lab Applications



## Small Sized Storage Series (Square Racks)

431/432

### Key Features

- Heavy duty lockable enclosure offers excellent security
- Strong, lightweight aluminium construction
- Dual handles
- Temperature monitoring available
- Roller bases available
- High thermal efficiency
- 5 years vacuum warranty
- Ultra-low LN<sub>2</sub> evaporation loss

### Product Advantages

#### Low LN<sub>2</sub> Consumption and Maximum Storage Efficiency

Haier Biomedical's Small Sized Storage Series (Square Racks) Liquid Nitrogen Storage System features low LN<sub>2</sub> consumption and small storage capacity for laboratory applications. The lightweight containers have a smaller footprint whilst providing maximum efficiency of cryogenic storage capacity.

#### Advanced Vacuum Technology and Super-insulation Technology

Advanced vacuum and insulation technologies provide ultra-low liquid nitrogen evaporation loss and ensure up to three months cryogenic storage.

#### Five Models Available

Small Sized Storage Series (Square Racks) offers Five models with different capacity from 100, 600, 750, 900 to 1100 standard 2ml cryovials. All models are supplied with stainless steel racks and cryogenic boxes.



### Accessories

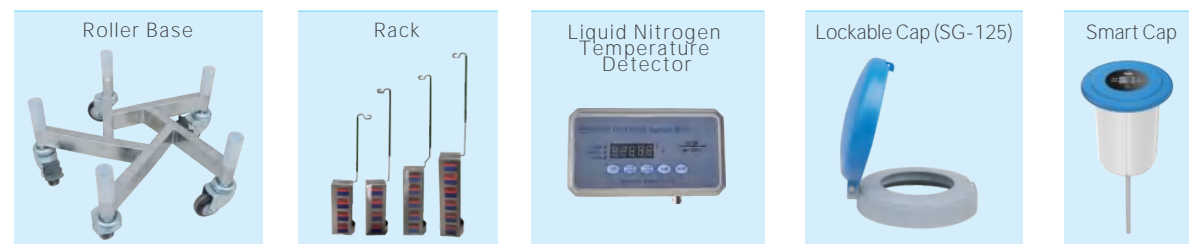

### Technical Parameters

Model	YDS-10-125	YDS-30-125	YDS-35-125	YDS-47-127	YDS-50B-125
<b>Maximum Storage Capacity</b>					
No. of Rack	1	6	6	6	6
1.2&2 ml Cryovials (25 per box)	100	600	750	1110	900
No. of Boxes in (Rack)	4	4	5	5	6
<b>Performance</b>					
Volume of LN <sub>2</sub> (L)	10	30	35	47	50
Static Evaporation* (L/Day)	0.42	0.35	0.36	0.36	0.45
Static Holding Time** (Day)	24	90	97	130	110
<b>Dimensions</b>					
Opening Diameter (mm)	125	125	125	127	125
Height (mm)	625	725	765	740	830
Outside Diameter (mm)	300	462	462	508	462
Empty Weight (kg)	6.3	13	14.5	18.2	17.3
Full Weight (kg)	15.1	38.9	43.2	60.9	62.4
Shipping Weight (kg)	9.6	19.3	21.9	30.7	30.3

\* Static evaporation and static holding time are theoretical values. Actual evaporation and holding time are affected by usage, atmospheric conditions and manufacturing tolerances.

\*\* Static Holding Time: the amount of days it takes for all of the LN<sub>2</sub> to evaporate out after container is filled with liquid nitrogen to pre-cool and reach thermal equilibrium and the liquid nitrogen filling rate reaches 100% under standard atmospheric condition.

### Product List

Model	Product	Product Model	Factory Code	Description and Accessories
YDS-10-125	Liquid Nitrogen container	YDS-10-125	YDS-10-125-FH	Include 1 square rack with 4 layers, 5*5 cryobox, lockable cap and PU bag.
	Liquid Nitrogen container	YDS-10-125	YDS-10-125-W	Includes PU bag only: No canister, no lockable cap.
	Rack	FTT-25-4H	FTT-25-4H	Used for storing 5*5 cryo boxes(2ml), 4 layers in total, with 5*5 cryo boxes included, suitable for YDS-30-125/YDS-10-125
	Canister	TTH10-125	TTH10-125	97,120mm single tier canister, No goblet, suitable for YDH-10-125
	SmartCap	T-125	T-125-6H180	Used for monitoring real time temperature for containers with 125mm neck opening, 6 grooves and 180mm high cork, data can be transmitted to Haier's IoT platform, suitable for YDH-10-125/YDS-10-125
	Cork (125)	GS-125-180	GS-125-180	Suitable for YDS-10-125/YDH-10-125/YDS-50B-125
	Lockable cap	SG-125	SG-125	Suitable for container with 125mm and 127mm neck opening
YDS-30-125	Liquid Nitrogen container	YDS-30-125	YDS-30-125-FH	Includes 6 racks with 4 layers, 5*5 cryoboxes, lockable cap and PU bag, roller base is optional.
	Liquid Nitrogen container	YDS-30-125	YDS-30-125-W	Includes PU bag only, roller base is optional
	Rack	FTT-25-4H	FTT-25-4H	Used for storing 5*5 cryo boxes(2ml), 4 layers in total, with 5*5 cryo boxes included, suitable for YDS-30-125/YDS-10-125
	Canister	TT30-125	TT30-125	97,120mm single tier canister, No goblet, suitable for YDS-30-125
	Roller Base	YSC-465-5W	YSC-465-5W	*Suitable for tanks with diameter less than Φ465. Can be used for 30L, 35L and 50L tank, equipped with 5 universal wheels.*
	SmartCap	LT-125	LT-125-370-6H540	Used for monitoring real time level and temperature for containers with 80mm neck opening, 6 grooves and 540mm height. Suitable for YDS-20-125/YDS-30-125
	Cork (125)	GS-125-210	GS-125-210	Suitable for YDS-30-125/YDS-35-125/YDS-47-127/YDS-35B-125
	Lockable cap	SG-125	SG-125	Suitable for container with 125mm and 127mm neck opening



## Small Sized Storage Series (Square Racks)

## Smart Level & Temp Monitoring

### Product List

Model	Product	Product Model	Factory Code	Description and Accessories
YDS-35-125	Liquid Nitrogen container	YDS-35-125	YDS-35-125-LYS	Includes 6 canisters (Height 276mm), lockable cap and PU bag, roller base is optional
	Liquid Nitrogen container	YDS-35-125	YDS-35-125-FH	Includes 6 racks with 5 layers, 5*5 cryoboxes, lockable cap and PU bag, roller base is optional.
	Liquid Nitrogen container	YDS-35-125	YDS-35-125-W	Includes PU bag only, roller base is optional
	Rack	FTT-25-5H	FTT-25-5H	Used for storing 5*5 cryo boxes (2ml), 5 layers in total, with 5*5 cryo boxes included, suitable for YDS-35-125
	Canister	TT35-125	TT35-125	97,120mm single tier canister, No goblet, suitable for YDS-35-125
	Canister	TTS35-125	TTS35-125	Φ97,276mm double-tier canister, 2 goblets included. Suitable for YDS-35-125
	Roller Base	YSC-465-5W	YSC-465-5W	"Suitable for tanks with diameter less than 465. Can be used for 30L, 35L and 50L tank, equipped with 5 universal wheels."
	SmartCap	LT-125	LT-125-400-6H575	Used for monitoring real time level and temperature for containers with 125mm neck opening, 6 grooves and 575mm height. suitable for YDS-25-125/YDS-35-125/YDS-35-125
	Cork (125)	GS-125-210	GS-125-210	Suitable for YDS-30-125/YDS-35-125/YDS-47-127/YDS-35B-125
Lockable cap	SG-125	SG-125	Suitable for container with 125mm and 127mm neck opening	
YDS-47-127	Liquid Nitrogen container	YDS-47-127	YDS-47-127-T37H	Includes 6 round rack with 5 layers (37 holes), lockable cap and PU bag; Roller base is optional
	Liquid Nitrogen container	YDS-47-127-10	YDS-47-127-10TS	"Includes 10 canisters(Φ72/276mm), lockable cap and PU bag, roller base is optional"
	Round Rack (Y98-37)	YTT-37-5	YTT-37-5	Φ98 round rack used for storing 37 holes cryobox (2ml), 5 tiers in total, suitable for YDS-47-127-T37
	Canister	TTS47-127-10T	TTS47-127-10T	Φ72, 276mm double-tier canister, 2 goblets included. Suitable for YDS-47-127-10T
	Roller Base	YSC-525-5W	YSC-525-5W	Suitable for tanks with diameter less than Φ525. Can be used for 47L aluminium tank, equipped with 5 universal wheels
	SmartCap	LT-127	LT-127-370-10H570	Used for monitoring real time level and temperature for containers with 127mm neck opening, 10 grooves and 570mm height. Suitable for YDS-47-127-10T/MVE-XC47/11-10
	SmartCap	LT-127	LT-127-400-6H570	Used for monitoring real time level and temperature for containers with 127mm neck opening, 6 grooves and 570mm height. suitable for YDS-47-127-6Y/YDS-47-127/MVE XC-47/11-6
	Cork (125)	GS-125-210	GS-125-210	Suitable for YDS-30-125/YDS-35-125/YDS-47-127/YDS-35B-125
	Cork (125)	GS-127-210-10	GS-127-210-10	Suitable for YDS-47-127-10T
Lockable cap	SG-125	SG-125	Suitable for container with 125mm and 127mm neck opening	
YDS-50B-125	Liquid Nitrogen container	YDS-50B-125	YDS-50B-125-FH	Includes 6 racks with 6 layers, 5*5 cryoboxes, lockable cap and PU bag, roller base is optional.
	Liquid Nitrogen container	YDS-50B-125	YDS-50B-125-LYS	"Includes 6 canisters (Φ97/276mm), lockable cap and PU bag, roller base is optional"
	Liquid Nitrogen container	YDS-50B-125	YDS-50B-125-W	Includes PU bag only, roller base is optional
	Rack	FTT-25-6H	FTT-25-6H	Used for storing 5*5 cryo boxes (2ml), 6 layers in total, with 5*5 cryo boxes included, suitable for YDS-50B-125
	Canister	TT50-125	TT50-125	97,120mm single tier canister, No goblet, suitable for YDS-50B-125
	Canister	TTS50-125	TTS50-125	Φ97,276mm double-tier canister, 2 goblets included. Suitable for YDS-50B-125
	Roller Base	YSC-465-5W	YSC-465-5W	"Suitable for tanks with diameter less than 465. Can be used for 30L, 35L and 50L tank, equipped with 5 universal wheels."
	SmartCap	LT-125	LT-125-500-6H670	Used for monitoring real time level and temperature for containers with 125mm neck opening, 6 grooves and 670mm height. suitable for YDS-50B-125
	Cork (125)	GS-125-180	GS-125-180	Suitable for YDS-10-125/YDH-10-125/YDS-50B-125
Lockable cap	SG-125	SG-125	Suitable for container with 125mm and 127mm neck opening	

### SmartCap

### Product Description

SmartCap is a low energy consumption module that can monitor liquid nitrogen level and temperature in a liquid nitrogen tank. It is suitable for aluminium alloy liquid nitrogen tanks with opening port size of 50mm, 80mm, 125mm, 216mm. The built-in high efficiency lithium battery can operate the device for more than two years.



SmartCap

### Product Characteristics

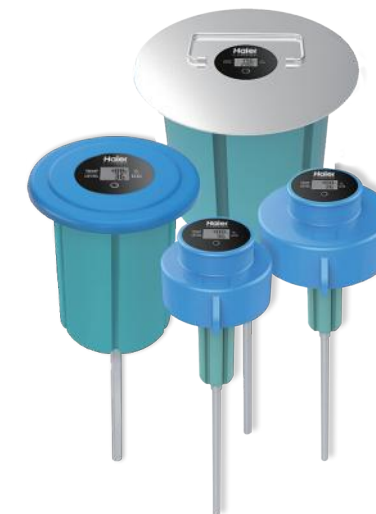

Independent, high accuracy measuring system for liquid level and temperature



Real time display of level and temperature.



Built-in high efficiency lithium battery for longevity

## Small Sized Storage Series (Square Racks)

### Product List

Model	Product	Product Model	Factory Code	Description and Accessories
Smart Cap	SmartCap	LT-50	LT-50-220-6H360	Used for monitoring real time level and temperature for containers with 50mm neck opening, 6 grooves and 360mm height. data can be transmitted to cloud platform, suitable for YDS-3/YDS-6
	SmartCap	LT-50	LT-50-280-6H420	Used for monitoring real time level and temperature for containers with 50mm neck opening, 6 grooves and 420mm height. suitable for YDS-10/YDS-15
	SmartCap	LT-50	LT-50-370-6H540	Used for monitoring real time level and temperature for containers with 50mm neck opening, 6 grooves and 540mm height. suitable for YDS-20/YDS-30
	SmartCap	LT-50	LT-50-400-6H570	Used for monitoring real time level and temperature for containers with 50mm neck opening, 6 grooves and 570mm height. suitable for YDS-25/YDS-35/YDS-35
	SmartCap	LT-50	LT-50-450-6H580	Used for monitoring real time level and temperature for containers with 50mm neck opening, 6 grooves and 580mm height. suitable for YDS-25/YDS-35
	SmartCap	LT-50	LT-50-500-6H640	Used for monitoring real time level and temperature for containers with 50mm neck opening, 6 grooves and 640mm height. suitable for YDS-50
	SmartCap	LT-80	LT-80-220-6H370	Used for monitoring real time level and temperature for containers with 80mm neck opening, 6 grooves and 370mm height. suitable for YDS-6-80
	SmartCap	LT-80	LT-80-280-6H430	Used for monitoring real time level and temperature for containers with 80mm neck opening, 6 grooves and 430mm height. suitable for YDS-10-80/YDS-15-80
	SmartCap	LT-80	LT-80-370-6H530	Used for monitoring real time level and temperature for containers with 80mm neck opening, 6 grooves and 530mm height. suitable for YDS-20-80/YDS-30-80
	SmartCap	LT-80	LT-80-400-6H580	Used for monitoring real time level and temperature for containers with 80mm neck opening, 6 grooves and 580mm height. suitable for YDS-25-80/YDS-35-80
	SmartCap	LT-80	LT-80-500-6H640	Used for monitoring real time level and temperature for containers with 80mm neck opening, 6 grooves and 640mm height. suitable for YDS-50-80
	SmartCap	LT-125	LT-125-280-6H445	Used for monitoring real time level and temperature for containers with 125mm neck opening, 6 grooves and 445mm height. suitable for YDS-10-125/YDS-15-125
	SmartCap	LT-125	LT-125-370-6H540	Used for monitoring real time level and temperature for containers with 80mm neck opening, 6 grooves and 540mm height. suitable for YDS-20-125/YDS-30-125
	SmartCap	LT-125	LT-125-400-6H575	Used for monitoring real time level and temperature for containers with 125mm neck opening, 6 grooves and 575mm height. suitable for YDS-25-125/YDS-35-125/YDS-35-125
	SmartCap	LT-125	LT-125-500-6H670	Used for monitoring real time level and temperature for containers with 125mm neck opening, 6 grooves and 670mm height. suitable for YDS-50B-125
	SmartCap	LT-127	LT-127-370-10H570	Used for monitoring real time level and temperature for containers with 127mm neck opening, 10 grooves and 570mm height. Suitable for YDS-47-127-10T/MVE-XC47/11-10
	SmartCap	LT-127	LT-127-400-6H570	Used for monitoring real time level and temperature for containers with 127mm neck opening, 6 grooves and 570mm height. suitable for YDS-47-127-6Y/YDS-47-127/MVE XC-47/11-6
	SmartCap	LT-216	LT-216-340-6H530	Used for monitoring real time level and temperature for containers with 216mm neck opening, 6 grooves and 530mm height. suitable for YDS-65-216
	SmartCap	LT-216	LT-216-340-4H540D1	Used for monitoring real time level and temperature for containers with 216mm neck opening, 4 grooves and 540mm height. suitable for Thermo-Locator Jr.plus(CY50925-70THERMO)/MVE CroySystem 2000
	SmartCap	LT-216	LT-216-370-6H580	Used for monitoring real time level and temperature for containers with 216mm neck opening, 6 grooves and 580mm height. suitable for YDS-95-216
	SmartCap	LT-216	LT-216-450-6H660	Used for monitoring real time level and temperature for containers with 216mm neck opening, 6 grooves and 660mm height. suitable for YDS-115-216
	SmartCap	LT-216	LT-216-570-6H770	Used for monitoring real time level and temperature for containers with 216mm neck opening, 6 grooves and 770mm height. suitable for YDS-145-216
	SmartCap	LT-216	LT-216-670-6H870	Used for monitoring real time level and temperature for containers with 216mm neck opening, 6 grooves and 870mm height. suitable for YDS-175-216
	SmartCap	T-50	T-50-6H180	Used for monitoring real time temperature for containers with 50mm neck opening, 6 grooves and 180mm high cork, data can be transmitted to Haier's IoT platform. suitable for YDH-3
	SmartCap	T-80	T-80-6H180	Used for monitoring real time temperature for containers with 80mm neck opening, 6 grooves and 180mm high cork, data can be transmitted to Haier's IoT platform. suitable for YDH-6-80
	SmartCap	T-125	T-125-6H180	Used for monitoring real time temperature for containers with 125mm neck opening, 6 grooves and 180mm high cork, data can be transmitted to Haier's IoT platform. suitable for YDH-10-125/YDS-10-125
	SmartCap	T-216	T-216-6H150	Used for monitoring real time temperature for containers with 216mm neck opening, 6 grooves and 150mm high cork, data can be transmitted to Haier's IoT platform. suitable for YDH-15-216
	SmartCap	T-216	T-216-6H210	Used for monitoring real time temperature for containers with 125mm neck opening, 6 grooves and 180mm high cork, data can be transmitted to Haier's IoT platform. suitable for YDH-10-125/YDS-10-125
Smart Box	Data repeater	RP-3002G	SG-300	SIM card to transfer data through GPRS and WIFI: include the SIM card
	Data transfer module-WIFI	RP-300W	RP-300W	WIFI to transfer data: prior for client not in China
	SMS alarm service cost	SMS alarm service cost	SMS alarm service cost	Not recommended
	Cloud platform service cost	Cloud platform service cost	Cloud platform service cost	Suitable for SJ CRYO'S service, charged by quantity of container, 1 year/set

## High Capacity Series for Storage or Transport (Round Canisters)

High Capacity Series for Storage or Transport (Round Canisters) provides two cryopreservation solutions for long-term static storage and transportation of biological samples.

- Numbered Index Canister Locations
- High Capacity
- High Thermal Efficiency
- 5 Years Vacuum Warranty
- Extended Hold Time
- LN<sub>2</sub> Dispenser
- Round Canisters for Straw Storage
- Lockable
- Roller Bases Available



# High Capacity Series for Storage or Transport (Round Canisters)

## Key Features

- Strong and lightweight aluminium construction
- Heavy duty lockable enclosure offers excellent security
- Numbered index location points for canisters
- Straw storage
- LN<sub>2</sub> dispense pump available
- Roller bases available
- High thermal efficiency
- 5 years vacuum warranty
- Ultra-low evaporation loss

## Product Advantages

Narrow neck design and excellent thermal conductivity reduces evaporation loss of liquid nitrogen to extend storage times.

Large-capacity models have wider necks for easy access to biological samples.

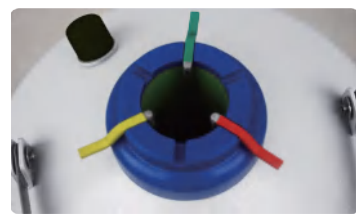
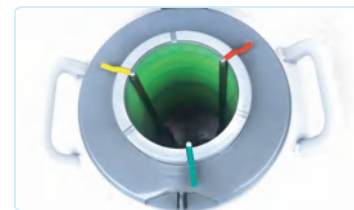

Long-term cryopreservation models have narrower necks with less heat intrusion.

## Technical Parameters

	Model	YDS-2-30	YDS-2-35	YDS-3	YDS-6	YDS-10	YDS-10-80
Maximum Capacity	No. of Canister	3 (3)	3 (3)	6 (0)	6 (0)	6 (0)	6 (0)
	No. of Straws (Single Layer) (0.5ml each canister)	90	165	792	792	792	2244
	No. of Straws (Single Layer) (0.25ml each canister)	204	330	1788	1788	1788	5022
	No. of Straws (Double Layer) (0.5ml each canister)	—	—	—	—	—	—
	No. of Straws (Double Layer) (0.25ml each canister)	—	—	—	—	—	—
Performance	Volume of LN <sub>2</sub> (L)	2	2	3	6	10	10
	Static Evaporation* (L/Day)	0.07	0.08	0.12	0.12	0.12	0.21
	Static Holding Time** (Day)	28	24	26	52	86	48
Dimensions	Opening Diameter (mm)	30	35	50	50	50	80
	Height (mm)	415	435	445	495	565	567
	Outside Diameter (mm)	223	204	223	300	300	300
	Canister Outside Diameter (mm)	19	25	38	38	38	63
	Outside Height (mm)	120	120	120	120	120	120
	Empty Weight (kg)	2.8	2.6	3.1	4.8	6.1	6.2
	Full Weight (kg)	4.5	4.4	6	9.9	14.5	14.7
Shipping Weight (kg)	5.1	4.9	5.8	8	9	9.3	

	Model	YDS-10-125	YDS-13	YDS-15	YDS-20	YDS-30
Maximum Capacity	No. of Canister	1 (0)	6 (0)	6 (0)	6 (0)	6
	No. of Straws (Single Layer) (0.5ml each canister)	854	-	792	792	792
	No. of Straws (Single Layer) (0.25ml each canister)	1940	-	1788	1788	1788
	No. of Straws (Double Layer) (0.5ml each canister)	-	1284	-	1284	1284
	No. of Straws (Double Layer) (0.25ml each canister)	-	2832	-	2832	2832
Performance	Volume of LN <sub>2</sub> (L)	10	13	15	20	30
	Static Evaporation* (L/Day)	0.42	0.12	0.11	0.12	0.12
	Static Holding Time** (Day)	24	109	134	168	254
Dimensions	Opening Diameter (mm)	125	50	50	50	50
	Height (mm)	625	635	610	700	725
	Outside Diameter (mm)	300	310	394	394	462
	Canister Outside Diameter (mm)	97	38	38	38	38
	Outside Height (mm)	120	276	120	120/276	120/276
	Empty Weight (kg)	6.3	6.3	8.5	9.5	12.9
	Full Weight (kg)	15.1	17.3	20.5	28.1	36.6
	Shipping Weight (kg)	8.6	11	13	15	18

	Model	YDS-30-80	YDS-30-125	YDS-35	YDS-35-80	YDS-35-125	YDS-47-127
Maximum Capacity	No. of Canister	6 (0)	6 (0)	6 (0)	6 (0)	6 (0)	10 (0)
	No. of Straws (Single Layer) (0.5ml each canister)	2244	5124	792	2244	5124	-
	No. of Straws (Single Layer) (0.25ml each canister)	5022	11640	1788	5022	11640	-
	No. of Straws (Double Layer) (0.5ml each canister)	3624	-	1284	3624	9048	8200
	No. of Straws (Double Layer) (0.25ml each canister)	8460	-	2832	8460	20760	16400
Performance	Volume of LN <sub>2</sub> (L)	30	30	35	35	35	47
	Static Evaporation* (L/Day)	0.21	0.35	0.12	0.22	0.37	0.36
	Static Holding Time** (Day)	147	90	286	159	97	130
Dimensions	Opening Diameter (mm)	80	125	50	80	125	127
	Height (mm)	729	725	765	768	765	740
	Outside Diameter (mm)	462	462	462	462	462	508
	Canister Outside Diameter (mm)	63	97	38	63	97	72
	Outside Height (mm)	120/276	120	120/276	120/276	120/276	276
	Empty Weight (kg)	13	13	14.2	14.5	14.6	18.2
	Full Weight (kg)	37	38.9	42.7	42.9	43.2	56.2
Shipping Weight (kg)	18.3	19.3	20	20.7	22	28	



# High Capacity Series for Storage or Transport (Round Canisters)

Model		YDS-20B	YDS-30B	YDS-35B
Maximum Capacity	No. of Canister	6 (0)	6 (0)	6 (0)
	No. of Straws (Single Layer) (0.5ml each canister)	792	792	792
	No. of Straws (Single Layer) (0.25ml each canister)	1788	1788	1788
	No. of Straws (Double Layer) (0.5ml each canister)	1284	1284	1284
	No. of Straws (Double Layer) (0.25ml each canister)	2832	2832	2832
Performance	Volume of LN <sub>2</sub> (L)	20	30	35
	Static Evaporation* (L/Day)	0.2	0.2	0.2
	Static Holding Time** (Day)	101	159	179
Dimensions	Opening Diameter (mm)	50	50	50
	Height (mm)	700	725	765
	Outside Diameter (mm)	394	462	462
	Canister Outside Diameter (mm)	38	38	38
	Outside Height (mm)	120/276	120/276	120/276
	Empty Weight (kg)	9.5	12.9	14.2
	Full Weight (kg)	27.9	37.1	42.8
Shipping Weight (kg)	15.1	18.3	20.1	

Model		YDS-35B-80	YDS-35B-125	YDS-50B	YDS-50B-125
Maximum Capacity	No. of Canister	6 (0)	6 (0)	6 (0)	6 (0)
	No. of Straws (Single Layer) (0.5ml each canister)	2244	5124	792	5124
	No. of Straws (Single Layer) (0.25ml each canister)	5022	11640	1788	11640
	No. of Straws (Double Layer) (0.5ml each canister)	3624	9048	1284	9048
	No. of Straws (Double Layer) (0.25ml each canister)	8460	20760	2832	20760
Performance	Volume of LN <sub>2</sub> (L)	35	35	50	50
	Static Evaporation* (L/Day)	0.3	0.41	0.24	0.45
	Duration of Normal Operation** (Day)	119	86	213	110
Dimensions	Opening Diameter (mm)	80	125	50	125
	Height (mm)	768	765	825	830
	Outside Diameter (mm)	462	462	462	462
	Canister Outside Diameter (mm)	63	97	38	97
	Outside Height (mm)	120/276	120/276	120/276	120/276
	Empty Weight (kg)	14.5	14.6	17.2	17.3
	Full Weight (kg)	43	43.5	60.3	62
Shipping Weight (kg)	20.7	22	24	25.4	

† A(B): A for maximum number of canisters, B for number of canisters in standard configuration

\* Static evaporation and static holding time are theoretical values. Actual evaporation and holding time are affected by usage, atmospheric conditions and manufacturing tolerances.

\*\* Static Holding Time: the amount of days it takes for all of the LN to evaporate out after container is filled with liquid nitrogen to pre-cool and reach thermal equilibrium and the liquid nitrogen filling rate reaches 100% under standard atmospheric condition.

## Vials Cane Specification

Canister	Height 120mm, Diameter 38mm (50mm neck)		
Vials	Canes/Canister	Vials/Cane	Vials/Canister
0.5ml	4	3	12
1.5ml	4	3	12
2ml	4	3	12
3ml	4	3	12
5ml	4	1	4

Canister	Height 276mm, Diameter 38mm (50mm neck)		
Vials	Canes/Canister	Vials/Cane	Vials/Canister
0.5ml	4	6	24
1.5ml	4	6	24
2ml	4	6	24
3ml	4	6	24
5ml	4	3	12

Canister	Height 120mm, Diameter 63mm (80mm neck)		
Vials	Canes/Canister	Vials/Cane	Vials/Canister
0.5ml	16	3	48
1.5ml	16	3	48
2ml	16	3	48
3ml	16	3	48
5ml	16	1	16

Canister	Height 276mm, Diameter 63mm (80mm neck)		
Vials	Canes/Canister	Vials/Cane	Vials/Canister
0.5ml	16	6	96
1.5ml	16	6	96
2ml	16	6	96
3ml	16	6	96
5ml	16	3	48

Canister	Height 120mm, Diameter 72mm (127mm neck)		
Vials	Canes/Canister	Vials/Cane	Vials/Canister
0.5ml	21	3	63
1.5ml	21	3	63
2ml	21	3	63
3ml	21	3	63
5ml	21	1	21

Canister	Height 276mm, Diameter 72mm (127mm neck)		
Vials	Canes/Canister	Vials/Cane	Vials/Canister
0.5ml	21	6	126
1.5ml	21	6	126
2ml	21	6	126
3ml	21	6	126
5ml	21	3	63

Canister	Height 120mm, Diameter 97mm (125mm neck)		
Vials	Canes/Canister	Vials/Cane	Vials/Canister
0.5ml	-	-	-
1.5ml	40	3	120
2ml	40	3	120
3ml	40	3	120
5ml	40	1	40

Canister	Height 276mm, Diameter 97mm (125mm neck)		
Vials	Canes/Canister	Vials/Cane	Vials/Canister
0.5ml	-	-	-
1.5ml	40	6	240
2ml	40	6	240
3ml	40	6	240
5ml	40	3	120

Canister	Height 120mm, Diameter 104mm (127mm neck)		
Vials	Canes/Canister	Vials/Cane	Vials/Canister
0.5ml	-	-	-
1.5ml	46	3	138
2ml	46	3	138
3ml	46	3	138
5ml	46	1	46

Canister	Height 276mm, Diameter 104mm (127mm neck)		
Vials	Canes/Canister	Vials/Cane	Vials/Canister
0.5ml	-	-	-
1.5ml	46	6	276
2ml	46	6	276
3ml	46	6	276
5ml	46	3	138

## Accessories



# High Capacity Series for Storage or Transport (Round Canisters)

## Product List

Model	Product	Product Model	Factory Code	Description and Accessories
YDS-2-30	Liquid Nitrogen container	YDS-2-30	YDS-2-30-YS	Includes 3 canisters, lockable cap and PU bag
	Canister	TT2-30	TT2-30	19, 120mm single tier canister, No goblet, suitable for YDS-2-30
	Cork (30)	GS-30-125	GS-30-125	Suitable for YDS-2-30
	Lockable cap	SG-30	SG-30	Suitable for container with 30mm neck opening, suitable for YDS-2-30
YDS-2-35	Liquid Nitrogen container	YDS-2-35	YDS-2-35-YS	Includes 3 canisters, lockable cap and Braces for carrying, no PU bag
	Canister	TT2-35	TT2-35	25, 120mm single tier canister, No goblet, suitable for YDS-2-35
	Cork (30)	GS-35-125	GS-35-125	Suitable for YDS-2-35
	Lockable cap	SG-35	SG-35	Suitable for container with 35mm neck opening, suitable for YDS-2-35
YDS-3	Liquid Nitrogen container	YDS-3	YDS-3-YS	Includes 6 canisters (Height 120mm), lockable cap and PU bag
	Liquid Nitrogen container	YDS-3	YDS-3-W	Includes PU bag only
	Canister	TT3-50	TT3-50	38, 120mm single tier canister, No goblet, suitable for YDS-3
	Cork (50)	GS-50-180	GS-50-180	Suitable for YDS-3/YDH-3/YDS-6/YDS-10/YDS-13/YDS-25/YDS-50B
YDS-6	Liquid Nitrogen container	YDS-6	YDS-6-YS	Includes 6 canisters (Height 120mm), lockable cap and PU bag
	Liquid Nitrogen container	YDS-6	YDS-6-W	Includes PU bag only
	Canister	TT6-50	TT6-50	38, 120mm single tier canister, No goblet, suitable for YDS-6
	Cork (50)	GS-50-180	GS-50-180	Suitable for YDS-3/YDH-3/YDS-6/YDS-10/YDS-13/YDS-25/YDS-50B
YDS-10	Liquid Nitrogen container	YDS-10	YDS-10-YS	Includes 6 canisters (Height 120mm), lockable cap and PU bag
	Liquid Nitrogen container	YDS-10	YDS-10-W	Includes PU bag only
	Canister	TT10-50	TT10-50	38, 120mm single tier canister, No goblet, suitable for YDS-10
	Cork (50)	GS-50-180	GS-50-180	Suitable for YDS-3/YDH-3/YDS-6/YDS-10/YDS-13/YDS-25/YDS-50B
YDS-10-80	Liquid Nitrogen container	YDS-10-80	YDS-10-80-YS	Includes 6 canisters (Height 120mm), lockable cap and PU bag
	Liquid Nitrogen container	YDS-10-80	YDS-10-80-W	Includes PU bag only
	Canister	TT10-80	TT10-80	Φ63, 120mm single tier canister, No goblet, suitable for YDS-10-80
	Cork (80)	GS-80-180	GS-80-180	Suitable for YDH-6-80/YDS-10-80
YDS-13	Liquid Nitrogen container	YDS-13	YDS-13-LYS	Includes 6 canisters (Height 276mm), lockable cap and PU bag
	Liquid Nitrogen container	YDS-13	YDS-13-W	Includes PU bag only
	Canister	TTS13-50	TTS13-50	Φ38, 276mm double-tier canister, 2 goblets included. Suitable for YDS-13
	Cork (50)	GS-50-180	GS-50-180	Suitable for YDS-3/YDH-3/YDS-6/YDS-10/YDS-13/YDS-25/YDS-50B
YDS-30	Liquid Nitrogen container	YDS-30	YDS-30-LYS	Includes 6 canisters (Height 276mm), lockable cap and PU bag, roller base is optional
	Liquid Nitrogen container	YDS-30	YDS-30-YS	Includes 6 canisters (Height 120mm), lockable cap and PU bag, roller base is optional
	Liquid Nitrogen container	YDS-30	YDS-30-W	Includes PU bag only, roller base is optional
	Canister	TT30-50	TT30-50	38, 120mm single tier canister, No goblet, suitable for YDS-20/YDS-30
YDS-30-80	Liquid Nitrogen container	YDS-30-80	YDS-30-80-LYS	Includes 6 canisters (Height 276mm), lockable cap and PU bag, roller base is optional
	Liquid Nitrogen container	YDS-30-80	YDS-30-80-YS	Includes 6 canisters (Height 120mm), lockable cap and PU bag, roller base is optional
	Liquid Nitrogen container	YDS-30-80	YDS-30-80-W	Includes PU bag only, roller base is optional
	Canister	TT30-80	TT30-80	63, 120mm single tier canister, No goblet, suitable for YDS-30-80
YDS-35	Liquid Nitrogen container	YDS-35	YDS-35-LYS	Includes 6 canisters (Height 276mm), lockable cap and PU bag, roller base is optional
	Liquid Nitrogen container	YDS-35	YDS-35-YS	Includes 6 canisters (Height 120mm), lockable cap and PU bag, roller base is optional
	Liquid Nitrogen container	YDS-35	YDS-35-W	Includes PU bag only, roller base is optional
	Canister	TT35-50	TT35-50	38, 120mm single tier canister, No goblet, suitable for YDS-25/YDS-35
YDS-35-80	Liquid Nitrogen container	YDS-35-80	YDS-35-80-LYS	Includes 6 canisters (Height 276mm), lockable cap and PU bag, roller base is optional
	Liquid Nitrogen container	YDS-35-80	YDS-35-80-W	Includes PU bag only, roller base is optional
	Canister	TT35-80	TT35-80	63, 120mm single tier canister, No goblet, suitable for YDS-35-80
	Canister	TTS35-80	TTS35-80	Φ63, 276mm double-tier canister, 2 goblets included. Suitable for YDS-35-80

## Product List

Model	Product	Product Model	Factory Code	Description and Accessories
YDS-15	Liquid Nitrogen container	YDS-15	YDS-15-YS	Includes 6 canisters (Height 120mm), lockable cap and PU bag
	Liquid Nitrogen container	YDS-15	YDS-15-W	Includes PU bag only
	Canister	TT15-50	TT15-50	38, 120mm single tier canister, No goblet, suitable for YDS-15
	Cork (50)	GS-50-210	GS-50-210	Suitable for YDS-15/YDS-20/YDS-30/YDS-35/YDS-20B/YDS-30B/YDS-35B
YDS-20	Liquid Nitrogen container	YDS-20	YDS-20-LYS	Includes 6 canisters (Height 276mm), lockable cap and PU bag
	Liquid Nitrogen container	YDS-20	YDS-20-YS	Includes 6 canisters (Height 120mm), lockable cap and PU bag
	Liquid Nitrogen container	YDS-20	YDS-20-W	Includes PU bag only
	Canister	TT30-50	TT30-50	38, 120mm single tier canister, No goblet, suitable for YDS-20/YDS-30
YDS-30	Liquid Nitrogen container	YDS-30	YDS-30-LYS	Includes 6 canisters (Height 276mm), lockable cap and PU bag, roller base is optional
	Liquid Nitrogen container	YDS-30	YDS-30-YS	Includes 6 canisters (Height 120mm), lockable cap and PU bag, roller base is optional
	Liquid Nitrogen container	YDS-30	YDS-30-W	Includes PU bag only, roller base is optional
	Canister	TT30-50	TT30-50	38, 120mm single tier canister, No goblet, suitable for YDS-20/YDS-30
YDS-30-80	Liquid Nitrogen container	YDS-30-80	YDS-30-80-LYS	Includes 6 canisters (Height 276mm), lockable cap and PU bag, roller base is optional
	Liquid Nitrogen container	YDS-30-80	YDS-30-80-YS	Includes 6 canisters (Height 120mm), lockable cap and PU bag, roller base is optional
	Liquid Nitrogen container	YDS-30-80	YDS-30-80-W	Includes PU bag only, roller base is optional
	Canister	TT30-80	TT30-80	63, 120mm single tier canister, No goblet, suitable for YDS-30-80
YDS-35	Liquid Nitrogen container	YDS-35	YDS-35-LYS	Includes 6 canisters (Height 276mm), lockable cap and PU bag, roller base is optional
	Liquid Nitrogen container	YDS-35	YDS-35-YS	Includes 6 canisters (Height 120mm), lockable cap and PU bag, roller base is optional
	Liquid Nitrogen container	YDS-35	YDS-35-W	Includes PU bag only, roller base is optional
	Canister	TT35-50	TT35-50	38, 120mm single tier canister, No goblet, suitable for YDS-25/YDS-35
YDS-35-80	Liquid Nitrogen container	YDS-35-80	YDS-35-80-LYS	Includes 6 canisters (Height 276mm), lockable cap and PU bag, roller base is optional
	Liquid Nitrogen container	YDS-35-80	YDS-35-80-W	Includes PU bag only, roller base is optional
	Canister	TT35-80	TT35-80	63, 120mm single tier canister, No goblet, suitable for YDS-35-80
	Canister	TTS35-80	TTS35-80	Φ63, 276mm double-tier canister, 2 goblets included. Suitable for YDS-35-80

# High Capacity Series for Storage or Transport (Round Canisters)

## Product List

Model	Product	Product Model	Factory Code	Description and Accessories
YDS-20B	Liquid nitrogen container	YDS-20B	YDS-20B-W	Includes PU bag only.
	Canister	TT30-50	TT30-50	38,120mm single tier canister, No goblet, suitable for YDS-20/YDS-30
	Canister	TTS30-50	TTS30-50	38,276mm double-tier canister, 2 goblets included. Suitable for YDS-20/YDS-30
	Cork (50)	GS-50-210	GS-50-210	Suitable for YDS-15/YDS-20/YDS-30/YDS-35/YDS-20B/YDS-30B/YDS-35B
	Lockable cap	SG-50	SG-50	Suitable for container with 50mm neck opening
YDS-30B	Liquid nitrogen container	YDS-30B	YDS-30B-W	Includes PU bag only, roller base is optional
	Canister	TT30-50	TT30-50	38,120mm single tier canister, No goblet, suitable for YDS-20/YDS-30
	Canister	TTS30-50	TTS30-50	38,276mm double-tier canister, 2 goblets included. Suitable for YDS-20/YDS-30
	Roller base	YSC-465-5W	YSC-465-5W	Suitable for tanks with diameter less than 465. Can be used for 30L, 35L and 50L tank, equipped with 5 universal wheels.
	Cork (50)	GS-50-210	GS-50-210	Suitable for YDS-15/YDS-20/YDS-30/YDS-35/YDS-20B/YDS-30B/YDS-35B
	Lockable cap	SG-50	SG-50	Suitable for container with 50mm neck opening
YDS-35B	Liquid nitrogen container	YDS-35B	YDS-35B-W	Includes PU bag only, roller base is optional
	Canister	TT35-50	TT35-50	38,120mm single tier canister, No goblet, suitable for YDS-25/YDS-35
	Canister	TTS35-50	TTS35-50	38,276mm double-tier canister, 2 goblets included. Suitable for YDS-35
	Roller base	YSC-465-5W	YSC-465-5W	Suitable for tanks with diameter less than 465. Can be used for 30L, 35L and 50L tank, equipped with 5 universal wheels.
	Cork (50)	GS-50-210	GS-50-210	Suitable for YDS-15/YDS-20/YDS-30/YDS-35/YDS-20B/YDS-30B/YDS-35B
	Lockable cap	SG-50	SG-50	Suitable for container with 50mm neck opening

## Product List

Model	Product	Product Model	Factory Code	Description and Accessories
YDS-35B-80	Liquid Nitrogen container	YDS-35B-80	YDS-35B-80-W	Includes PU bag only, roller base is optional
	Canister	TT35-80	TT35-80	63,120mm single tier canister, No goblet, suitable for YDS-35-80
	Canister	TTS35-80	TTS35-80	63,276mm double-tier canister, 2 goblets included. Suitable for YDS-35-80
	Roller Base	YSC-465-5W	YSC-465-5W	"Suitable for tanks with diameter less than 465. Can be used for 30L, 35L and 50L tank, equipped with 5 universal wheels."
	Cork (80)	GS-80-210	GS-80-210	Suitable for YDS-30-80/YDS-35-80/YDS-35B-80
	Lockable cap	SG-80	SG-80	Suitable for container with 80mm neck opening
YDS-35B-125	Liquid Nitrogen container	YDS-35B-125	YDS-35B-125-W	Includes PU bag only
	Canister	TT35-125	TT35-125	97,120mm single tier canister, No goblet, suitable for YDS-35-125
	Canister	TTS35-125	TTS35-125	97,276mm double-tier canister, 2 goblets included. Suitable for YDS-35-125
	Rack	FTT-25-5H	FTT-25-5H	Used for storing 5*5 cryo boxes(2ml), 5 layers in total, with 5*5 cryo boxes included, suitable for YDS-35-125
	Roller Base	YSC-465-5W	YSC-465-5W	"Suitable for tanks with diameter less than 465. Can be used for 30L, 35L and 50L tank, equipped with 5 universal wheels."
	Cork (125)	GS-125-210	GS-125-210	Suitable for YDS-30-125/YDS-35-125/YDS-47-127/YDS-35B-125
YDS-50B	Liquid Nitrogen container	YDS-50B	YDS-50B-W	Includes PU bag only, roller base is optional
	Canister	TT50-50	TT50-50	38,120mm single tier canister, No goblet, suitable for YDS-50
	Canister	TTS50-50	TTS50-50	38,276mm double-tier canister, 2 goblets included. Suitable for YDS-50
	Roller Base	YSC-465-5W	YSC-465-5W	"Suitable for tanks with diameter less than 465. Can be used for 30L, 35L and 50L tank, equipped with 5 universal wheels."
	Smart cap	LT-50-500-6H640	LT-50-500-6H640	Used for monitoring real time level and temperature for containers with 50mm neck opening, 6 grooves and 640mm height. suitable for YDS-50
	Cork (50)	GS-50-180	GS-50-180	Suitable for YDS-3/YDH-3/YDS-6/YDS-10/YDS-13/YDS-25/YDS-50B
	Lockable cap	SG-50	SG-50	Suitable for container with 50mm neck opening



## Dryshipper Series for Transportation (Round Canisters)

445/446

*Dryshipper Series for Transportation (Round Canisters) is designed for safe sample transportation under cryogenic conditions (vapour phase storage, temperature under  $-190^{\circ}\text{C}$ ). Since the risk of  $\text{LN}_2$  release is avoided, it is suitable for air transportation of samples.*

- Rugged and Durable
- 3 Years Vacuum Warranty
- Cryo Absorbant
- Vapour Phase Storage
- Secure
- No  $\text{LN}_2$  Spillage



### Key Features

- Straw and cryovial storage options
- Rugged and durable aluminium construction
- Designed to ensure no  $\text{LN}_2$  spillage
- Vapour phase cryogenic storage
- Faster  $\text{LN}_2$  fill times
- Lockable lids
- 3 years vacuum warranty

### Product Advantages

#### Liquid Nitrogen Adsorption

Adsorbent materials are used to absorb and retain  $\text{LN}_2$  for safe transport. No spillover of  $\text{LN}_2$  can occur even when the tank is capsized.

#### Stainless Steel Mesh

Special stainless steel mesh divides storage space and  $\text{LN}_2$  absorbents to prevent absorbent materials from contaminating the samples.

#### Complete Accessories Set

All models are offered a variety of stainless steel canisters and polycarbonate cryogenic boxes. Locking cover is optional.



### Accessories

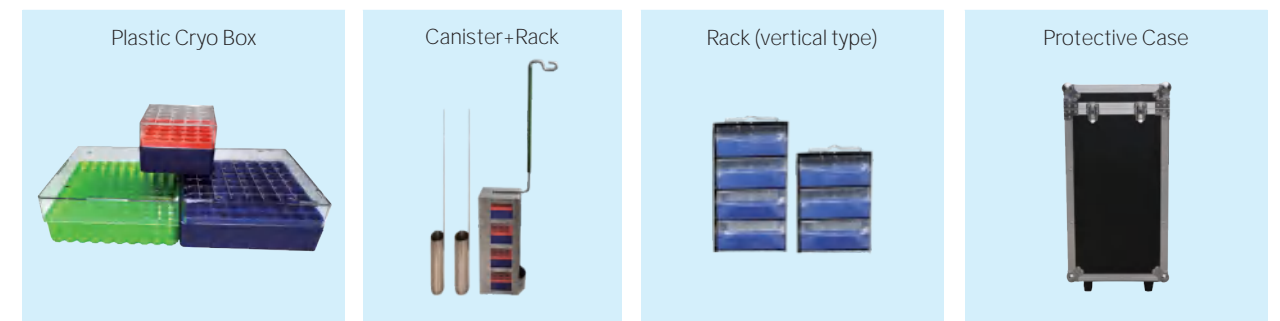

# Dryshipper Series for Transportation (Round Canisters)

447/448

## Technical Parameters

Model	YDH-3	YDH-6-80	YDH-10-125	YDH-10-125	YDH-15-216	YDH-25-216
-------	-------	----------	------------	------------	------------	------------

### Maximum Storage Capacity

No. of Canister	1	1	1	1	1	1
No. of Straws (0.5ml / EA)	132	374	854	—	—	—
No. of Straws (0.25ml / EA)	298	837	1940	—	—	—
No. of 2.0 ml Cryovials	—	—	—	100	300	500
No. of Boxes in (2ml per holder)	—	—	—	—	3	5

### Performance

Absorbable Volume of LN <sub>2</sub> (L)	1.3	2.9	3.4	3.4	6	9
Static Evaporation* (L/Day)	0.16	0.2	0.43	0.43	1.5	0.89
Vapour Phase Static Holding Time*** (Day)	8	14	8	8	4	10

### Dimensions

Opening Diameter (mm)	50	80	125	125	216	216
Height (mm)	445	500	625	625	555	730
Outside Diameter (mm)	223	300	300	300	394	394
Canister Outside Diameter (mm)	38	63	97	—	—	—
Outside Height (mm)	120	120	120	—	—	—
Empty Weight (kg)	3.2	6.5	8.9	8.9	13	15
Full Weight (kg)	4.7	8.9	12.5	12.5	17.8	23
Shipping Weight (kg)	5.5	7.7	9.7	9.7	15.2	20.5

\* Static evaporation and static holding time are theoretical values. Actual evaporation and holding time are affected by usage, atmospheric conditions and manufacturing tolerances.

\*\* Liquid Phase Static Holding Time: the amount of days it takes for all of the LN to evaporate out after container is filled with liquid nitrogen to pre-cool and reach thermal equilibrium and the liquid nitrogen filling rate reaches 100% under standard atmospheric condition.

\*\*\* Vapour Phase Static Holding Time: the amount of days it takes for all of the LN to evaporate out after pouring liquid nitrogen into container to making absorbent materials fully absorb LN under standard atmospheric condition.

## Product List

Model	Product	Product Model	Factory Code	Description and Accessories
YDH-3	Dry shipper	YDH-3	YDH-3-YS	Includes 1 canister (Height 120mm), lockable cap and PU bag
	Canister	TTH3-50	TTH3-50	38,120mm single tier canister, No goblet, suitable for YDH-3
	Smart cap	T-50	T-50-6H180	Used for monitoring real time temperature for containers with 50mm neck opening, 6 grooves and 180mm high cork, data can be transmitted to Haier's IoT platform, suitable for YDH-3
	Cork (50)	GS-50-180	GS-50-180	Suitable for YDS-3/YDH-3/YDS-6/YDS-10/YDS-13/YDS-25/YDS-50B
	Lockable cap	SG-50	SG-50	Suitable for container with 50mm neck opening
YDH-6-80	Dry shipper	YDH-6-80	YDH-6-80-YS	Includes 1 canister (Height 120mm), lockable cap and PU bag
	Canister	TTH6-80	TTH6-80	63,120mm single tier canister, No goblet, suitable for YDH-6-80
	Smart cap	T-80	T-80-6H180	Used for monitoring real time temperature for containers with 80mm neck opening, 6 grooves and 180mm high cork, data can be transmitted to Haier's IoT platform, suitable for YDH-6-80
	Cork (80)	GS-80-180	GS-80-180	Suitable for YDH-6-80/YDS-10-80
	Lockable cap	SG-80	SG-80	Suitable for container with 80mm neck opening
YDH-10-125	Dry shipper	YDH-10-125	YDH-10-125-FH	Includes 1 rack (4 layers), 5*5 cryoboxes, lockable cap and PU bag
	Dry shipper	YDH-10-125	YDH-10-125-S	Includes lockable cap and PU bag, No Rack
	Rack	FTT-25-4H	FTT-25-4H	Used for storing 5*5 cryo boxes (2ml), 4 layers in total, with 5*5 cryo boxes included, suitable for YDS-30-125/YDS-10-125
	Canister	TTH10-125	TTH10-125	97,120mm single tier canister, No goblet, suitable for YDH-10-125
	Smart cap	T-125	T-125-6H180	Used for monitoring real time temperature for containers with 125mm neck opening, 6 grooves and 180mm high cork, data can be transmitted to Haier's IoT platform, suitable for YDH-10-125/YDS-10-125
	Cork (125)	GS-125-180	GS-125-180	Suitable for YDS-10-125/YDH-10-125/YDS-50B-125
	Lockable cap	SG-125	SG-125	Suitable for container with 125mm and 127mm neck opening
YDH-15-216	Dry shipper	YDH-15-216	YDH-15-216-FH	Includes 1 rack (3 layers), 9*9 cryoboxes, lockable cap and PU bag
	Rack (vertical type)	FDCJ-81-3H	FDCJ-81-3H	Used for storing 9*9 cryo boxes (2ml), 3 layers in total. With 9*9 cryoboxes included. Suitable for YDH-15-216
	Smart cap	T-216	T-216-6H150	Used for monitoring real time temperature for containers with 216mm neck opening, 6 grooves and 150mm high cork, data can be transmitted to Haier's IoT platform, suitable for YDH-15-216
	Cork (216-2)	GS-216-150 (L)	GS-216-150 (L)	Suitable for YDH-15-216
	Lockable cap	SG-216	SG-216	Suitable for container with 216mm neck opening
YDH-25-216	Dry shipper	YDH-25-216	YDH-25-216-FH	Includes 1 rack (5 layers), 9*9 cryoboxes, lockable cap and PU bag
	Rack (vertical type)	FDCJ-81-5H	FDCJ-81-5H	Used for storing 9*9 cryo boxes (2ml), 5 layers in total, with 9*9 cryoboxes included, suitable for YDH-25-216/YDS-95-216
	Smart cap	T-216	T-216-6H210	Used for monitoring real time temperature for containers with 216mm neck opening, 6 grooves and 210mm high cork, data can be transmitted to Haier's IoT platform, suitable for YDH-25-216/YDS-65-216/YDS-95-216/YDS-115-216/YDS-145-216/YDS-175-216
	Cork (216)	GS-216-220-7	GS-216-220-7	Suitable for YDS-65-216/YDS-95-216/YDS-115-216/YDS-145-216/YDS-175-216/YDH-15-216/YDH-25-216
	Lockable cap	SG-216	SG-216	Suitable for container with 216mm neck opening
YDH-25-216	Protective case	HXX-394/800	/	Suitable for YDH-25-216



# Self-pressurized Series for LN<sub>2</sub> Storage and Supply

*Liquid Nitrogen Supplement Series for LN<sub>2</sub> Storage and Supply incorporates the latest innovation, its unique design utilises the pressure generated from the vapourisation of a small amount liquid nitrogen to discharge LN<sub>2</sub> into other containers. Storage capacities range from 5 to 500 litres.*

- 5 Year Vacuum Warranty
- Decant Valves
- Liquid Storage
- Stainless Steel Construction
- Pressure Raising
- Integral Safety Mechanisms

## Key Features

- All models are equipped with safety valves
- All welded stainless steel construction
- Rotary ring construction
- Labelled valves for easy identification
- 5 year vacuum warranty

## Product Advantages

### Stainless Steel Structure

Stainless steel structure can withstand the most demanding environment and ensure long-lasting security. It also provides reduced evaporation loss rate, compared with conventional welding insulation tanks.

### Variety of accessories

Each Self-pressurized Series for LN<sub>2</sub> Storage and Supply model is equipped with a pressure valve, a drain valve, a relief valve, and a pressure gauge.

### Casters

All models have four casters for better mobility and convenient use in different occasions.

## Accessories

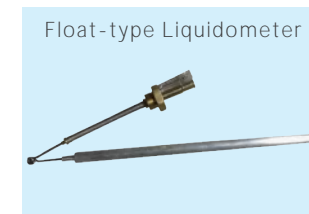

## Additional Series for Liquid Nitrogen Tank (Comparison between Standard Series and K Series)

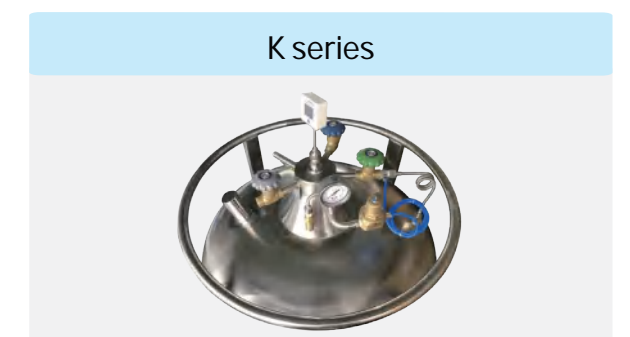

## New Functions of K Series

### Digital Display Level Gauge

DLZ-300  
Digital display of fluid level  
Remote data transmission  
function



### Large diameter vent valve

Rapid relief of  
over pressure  
Protection of  
safety valve



### Pressure stabilizing valve

Stabilize fluid pressure  
during auto filling





Self-pressurized Series for LN<sub>2</sub> Storage and Supply

451/452

## Technical Parameters

Model	YDZ-5	YDZ-15	YDZ-30	YDZ-50	YDZ-100 YDZ-100K
<b>Performance</b>					
Volume of LN <sub>2</sub> (L)	5	15	30	50	100
Static Evaporation (L/Day)	0.15	0.38	0.75	1	1.3
LN <sub>2</sub> Output (L/Min)	≥2	≥2	≥3	≥3	≥4
<b>Dimensions</b>					
Height (mm)	652	771	879	1009	1179
Outside Diameter (mm)	354	404	454	506	606
Empty Weight (kg)	19	26	32	54	86
Full Weight (kg)	23.0	38.1	62.2	94.4	166.8
Shipping Weight (kg)	32	37	53	63	107
Pressure Parameters (MPa)	1. Standard working pressure 0.05, 2. Maximum working pressure 0.09, 3. First stage safety valve relief pressure 0.099, 4. Second stage safety valve release pressure 0.15, 5. Pressure gauge range 0-0.25				
<b>Certification</b>					
PED	/	/	/	/	Y

Model	YDZ-150	YDZ-200 YDZ-200K	YDZ-240K	YDZ-300 YDZ-300K	YDZ-500 YDZ-500K
<b>Performance</b>					
LN <sub>2</sub> Capacity (L)	150	200	240	300	500
Static Evaporation (L/Day)	1.95	2.4	2.9	3.3	5.5
LN <sub>2</sub> Output (L/Min)	≥6	≥8	≥8	≥8	≥10
<b>Dimensions</b>					
Height (mm)	1208	1288	1405	1484	1607
Outside Diameter (mm)	706	758	758	858	1008
Empty Weight (kg)	107	145	159	193	273
Full Weight (kg)	228	307	353	435	677
Shipping Weight (kg)	137	179	188	223	342
Pressure Parameters (MPa)	1. Standard working pressure 0.05, 2. Maximum working pressure 0.09, 3. First stage safety valve relief pressure 0.099, 4. Second stage safety valve release pressure 0.15, 5. Pressure gauge range 0-0.25, 6. Rupture disc burst pressure 0.47				
<b>Certification</b>					
PED	/	/	Y	/	/

## Product List

Model	Product	Product Model	Factory Code	Description and Accessories
YDS	Self-pressurized Filling tank	YDZ-5	YDZ-5-W	Includes single-layer transfusion hoses (ZG-DN10/1.5)
	Self-pressurized Filling tank	YDZ-15	YDZ-15-W	Includes single-layer transfusion hoses (ZG-DN10/1.5)
	Self-pressurized Filling tank	YDZ-30	YDZ-30-W	Includes single-layer transfusion hoses (ZG-DN10/1.5)
	Self-pressurized Filling tank	YDZ-50	YDZ-50-W	Includes single-layer transfusion hoses (ZG-DN10/1.5)
	Self-pressurized Filling tank	YDZ-100	YDZ-100-F	Includes single-layer transfusion hoses (ZG-DN10/1.5) and float-type liquidometer
	Self-pressurized Filling tank	YDZ-150	YDZ-150-F	Includes single-layer transfusion hoses (ZG-DN10/1.5) and float-type liquidometer
	Self-pressurized Filling tank	YDZ-200	YDZ-200-F	Includes single-layer transfusion hoses (ZG-DN10/1.5) and float-type liquidometer
	Self-pressurized Filling tank	YDZ-300	YDZ-300-F	Includes single-layer transfusion hoses (ZG-DN10/1.5) and float-type liquidometer
	Self-pressurized Filling tank	YDZ-500	YDZ-500-F	Includes single-layer transfusion hoses (ZG-DN10/1.5) and float-type liquidometer
	Self-pressurized Filling tank	YDZ-100K	YDZ-100-K	Includes single-layer transfusion hoses (ZG-DN10/1.5), Digital display level gauge (DLZ-300) and pressure stabilizer. can be used for auto filling
	Self-pressurized Filling tank	YDZ-200K	YDZ-200-K	Includes single-layer transfusion hoses (ZG-DN10/1.5), Digital display level gauge (DLZ-300) and pressure stabilizer. can be used for auto filling
	Self-pressurized Filling tank	YDZ-240K	YDZ-240-K	Includes single-layer transfusion hoses (ZG-DN10/1.5), Digital display level gauge (DLZ-300) and pressure stabilizer. can be used for auto filling
	Self-pressurized Filling tank	YDZ-300K	YDZ-300-K	Includes single-layer transfusion hoses (ZG-DN10/1.5), Digital display level gauge (DLZ-300) and pressure stabilizer. can be used for auto filling
	Self-pressurized Filling tank	YDZ-320K	YDZ-320-K	Includes single-layer transfusion hoses (ZG-DN10/1.5), Digital display level gauge (DLZ-300) and pressure stabilizer. can be used for auto filling
	Self-pressurized Filling tank	YDZ-500K	YDZ-500-K	Includes single-layer transfusion hoses (ZG-DN10/1.5), Digital display level gauge (DLZ-300) and pressure stabilizer. can be used for auto filling
	Digital display level gauge	DLZ-300(YDZ-240K)	DLZ-300(YDZ-240K)	Digital display real time liquid nitrogen level of self pressurized tank, low power consumption battery, wireless transmission (YDZ-240K)
	Digital display level gauge	DLZ-300(YDZ-320K)	DLZ-300(YDZ-320K)	Digital display real time liquid nitrogen level of self pressurized tank, low power consumption battery, wireless transmission (YDZ-320K)
	Digital display level gauge	DLZ-300(YDZ-500K)	DLZ-300(YDZ-500K)	Digital display real time liquid nitrogen level of self pressurized tank, low power consumption battery, wireless transmission (YDZ-500K)
	Float-type Liquidometer	FZ-100	FZ-100	Suitable for YDZ-100
	Float-type Liquidometer	FZ-150	FZ-150	Suitable for YDZ-150
Float-type Liquidometer	FZ-200	FZ-200	Suitable for YDZ-200	
Float-type Liquidometer	FZ-300	FZ-300	Suitable for YDZ-300	
Float-type Liquidometer	FZ-500	FZ-500	Suitable for YDZ-500	

\* Static evaporation and static holding time are theoretical values. Actual evaporation and holding time are affected by usage, atmospheric conditions and manufacturing tolerances.

# Self-pressurized Series for LN<sub>2</sub> Storage and Supply

## Product List

Model	Product	Product Model	Factory Code	Description and Accessories
LN Pump	LN pump-Hand held type	YDB-5S-50	YDB-5S-50	Suitable for tank (20L-50L)with 50mm neck opening
	LN pump-Foot step type	YDB-8J-50	YDB-8J-50	Suitable for tank (20L-50L)with 50mm neck opening
Roller Base	Roller Base	YSC-600-5W	YSC-600-5W	Suitable for tanks with diameter less than 600. Suitable for GP 65L and 120L aluminium tank
	Roller Base	YSC-685-5W	YSC-685-5W	Suitable for all 65L-175L aluminium tank, equipped with 5 universal wheels
	Roller Base	YSC-465-5W	YSC-465-5W	*Suitable for tanks with diameter less than 465. Can be used for 30L, 35L and 50L tank, equipped with 5 universal wheels.*
	Roller Base	YSC-525-5W	YSC-525-5W	Suitable for tanks with diameter less than 525. Can be used for 47L aluminium tank, equipped with 5 universal wheels
YDS/YDZ Temperature Detector	Liquid Nitrogen Temperature Detector	ZTC-100A	ZTC-100A	Using platinum resistor to measure the temperature, and setting single-point level alarm through the temperature: with buzzer alarm function available
Full Bottom Canister	Full Bottom Canister	MTT2-30	MTT2-30	19, 120mm single tier canister (full bottom), No goblet, suitable for YDS-2-30
	Full Bottom Canister	MTT2-35	MTT2-35	25, 120mm single tier canister (full bottom), No goblet, suitable for YDS-2-35
	Full Bottom Canister	MTT3-50	MTT3-50	38, 120mm single tier canister (full bottom), No goblet, suitable for YDS-3
	Full Bottom Canister	MTTH3-50	MTTH3-50	38, 120mm single tier canister (full bottom), No goblet, suitable for YDH-3
	Full Bottom Canister	MTT6-50	MTT6-50	38, 120mm single tier canister (full bottom), No goblet, suitable for YDS-6
	Full Bottom Canister	MTT10-50	MTT10-50	38, 120mm single tier canister (full bottom), No goblet, suitable for YDS-10
	Full Bottom Canister	MTT15-50	MTT15-50	38, 120mm single tier canister (full bottom), No goblet, suitable for YDS-15
	Full Bottom Canister	MTT30-50	MTT30-50	38, 120mm single tier canister (full bottom), No goblet, suitable for YDS-20/YDS-30
	Full Bottom Canister	MTT35-50	MTT35-50	38, 120mm single tier canister (full bottom), No goblet, suitable for YDS-25、YDS-35
	Full Bottom Canister	MTT50-50	MTT50-50	38, 120mm single tier canister (full bottom), No goblet, suitable for YDS-50
	Full Bottom Canister	MTTH6-80	MTTH6-80	63, 120mm single tier canister (full bottom), No goblet, suitable for YDH-6-80
	Full Bottom Canister	MTT10-80	MTT10-80	63, 120mm single tier canister (full bottom), No goblet, suitable for YDS-10-80
	Full Bottom Canister	MTT30-80	MTT30-80	63, 120mm single tier canister (full bottom), No goblet, suitable for YDS-30-80
	Full Bottom Canister	MTT35-80	MTT35-80	63, 120mm single tier canister (full bottom), No goblet, suitable for YDS-35-80
	Full Bottom Canister	MTTH10-125	MTTH10-125	97, 120mm single tier canister (full bottom), No goblet, suitable for YDH-10-125
	Full Bottom Canister	MTT30-125	MTT30-125	97, 120mm single tier canister (full bottom), No goblet, suitable for YDS-30-125
	Full Bottom Canister	MTT35-125	MTT35-125	97, 120mm single tier canister (full bottom), No goblet, suitable for YDS-35-125
	Full Bottom Canister	MTT50-125	MTT50-125	97, 120mm single tier canister (full bottom), No goblet, suitable for YDS-50B-125
	Full Bottom Canister	MTTS13-50	MTTS13-50	38, 276mm double tiers canister (full bottom), with goblets included, suitable for YDS-13
	Full Bottom Canister	MTTS30-50	MTTS30-50	38, 276mm double tiers canister (full bottom), with goblets included, suitable for YDS-20/YDS-30
	Full Bottom Canister	MTTS35-50	MTTS35-50	38, 276mm double tiers canister (full bottom), with goblets included, suitable for YDS-25/YDS-35
	Full Bottom Canister	MTTS50-50	MTTS50-50	38, 276mm double tiers canister (full bottom), with goblets included, suitable for YDS-50
	Full Bottom Canister	MTTS30-80	MTTS30-80	63, 276mm double tiers canister (full bottom), with goblets included, suitable for YDS-30-80
	Full Bottom Canister	MTTS35-80	MTTS35-80	63, 276mm double tiers canister (full bottom), with goblets included, suitable for YDS-35-80
	Full Bottom Canister	MTTS47-127-10T	MTTS47-127-10T	72, 276mm double tiers canister (full bottom), with goblets included, suitable for YDS-47-127-10T
	Full Bottom Canister	MTTS35-125	MTTS35-125	97, 276mm double tiers canister (full bottom), with goblets included, suitable for YDS-35-125
	Full Bottom Canister	MTTS47-127	MTTS47-127	104, 276mm double tiers canister (full bottom), with goblets included, suitable for YDS-47-127
	Full Bottom Canister	MTTS50-125	MTTS50-125	97, 276mm double tiers canister (full bottom), with goblets included, suitable for YDS-50B-125

## Product List

Model	Product	Product Model	Factory Code	Description and Accessories
Cryobox	Vial cane	3X	3X	Used for holding 3 vials (2ml)
	Vial cane	6X	6X	Used for holding 6 vials (2ml), plastic sleeve not included
	Plastic cryo box	FH-25	FH-25	Used for storing 1.8ml/2ml vial (25 holes)
	Plastic cryo box	FH-81	FH-81	Used for storing 1.8ml/2ml vial (81 holes)
	Plastic cryo box	FH-81/5.0	FH-81/5.0	Used for storing 4.5/4.7/5ml vial (81 holes)
	Plastic cryo box	FH-100	FH-100	Used for storing 1.8ml/2ml vial (Internally threaded,100 holes)
	Plastic cryo box	YH-37	YH-37	Suitable for round rack to store 1.8ml/2ml vial (37 holes)
	Pastic Goblets	SNT-97	SNT-97	Suitable for diameter 97mm canisters
	Blood bag cassette	XH-25	XH-25	one bag per box,rocker arm type
	Blood bag cassette	XH-50	XH-50	one bag per box,drawer type
	Blood bag cassette	XH-250	XH-250	one bag per box, rocker arm type
	Plastic sleeve for vial cane	5016-0002 (6-type)	5016-0002 (6X)	Suitable for vial cane that can hold 6 vials
Other Accessories	Stainless steel cryo box	BH-25/5.0	BH-25/5.0	Used for storing 4.5ml/4.7ml/5ml vials (25 holes)
	Stainless steel cryo box	BH-81/5.0	BH-81/5.0	Used for storing 4.5ml/4.7ml/5ml vials (81 holes)
	Valve adaptor	CGA295	CGA295	Used for connecting the valve of YDZ self-pressurized tank with single layer transfer hose
	Cryogenic solenoid valve	DN7.0 (ASCO 24V)	DN7.0 (ASCO 24V)	Suitable for piping pressures≤0.5MPa, pressure 0.3MPa
	Cryogenic solenoid valve	DN7.0 (JASA 24V)	DN7.0 (JASA 24V)	Suitable for piping pressures≤0.5MPa
	Low temperature solenoid valve	DN3.0 (ASCO 24V)	DN3.0 (ASCO 24V)	Suitable for piping pressures≤0.5MPa, pressure 0.8MPa
	Vacuum isolated hose	GRG-DN10/1.0	GRG-DN10/1.0	Diameter 10mm, Length 1m, special use for liquid nitrogen transferring, connection type for both side and length can be customized, charged by meter
	Vacuum isolated hose	GRG-DN10/2.0	GRG-DN10/2.0	Diameter 10mm, Length 2m, special use for liquid nitrogen transferring, connection type for both side and length can be customized, charged by meter
	Single-layer transfusion Hose	ZG-DN10/1.5	ZG-DN10/1.5	Diameter 10mm, Length 1.5m, Suitable for YDZ series
	Single-layer transfusion Hose	BG-DN10/1.0	BG-DN10/1.0	Diameter 10mm, Length 1.0m, Suitable for liquid nitrogen pump YDB series
	Single-layer transfusion Hose	RG-DN10	RG-DN10	Diameter 10mm, used for liquid nitrogen transferring, fitting and length can be customized, charged in meters.
	Single-layer transfusion Hose	RG-DN6	RG-DN6	Diameter 6mm, used for liquid nitrogen transferring, fitting and length can be customized, charged in meters.
	Hose heat insulation cotton	BMT-DN10	BMT-DN10	Suitable for DN10 single layer metal hose, 1 meter
	Cryogenic gloves	ST-32	ST-32	overall length 32cm
	Cryogenic gloves	ST-45	ST-45	overall length 45cm
	Cryogenic gloves	ST-72	ST-72	overall length 72cm
	Level measuring scale	YWC-100	YWC-100	Measuring length 100CM

# Haier Biomedical Product Portfolio

## Cryo Freezer -86°C ULT Freezer

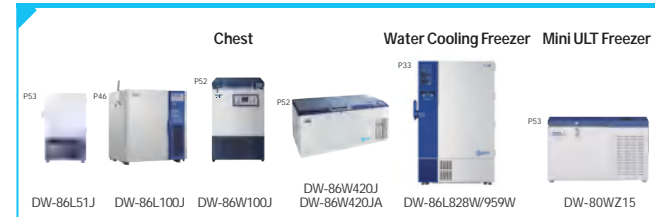

## -40°C Biomedical Freezer



## -30°C Biomedical Freezer



## Forced Air Cooling Freezer



## -25°C Biomedical Freezer



## Combined Refrigerator and Freezer



## Pharmacy Refrigerator



## Pharmacy Refrigerator



## Pharmacy Refrigerator



## Laboratory Refrigerator



## Spark Free Freezer/Refrigerator



## Smart Vaccine Refrigerator



## Ice-lined Refrigerator/Freezer



## Vaccine & Icepack Freezer



# Haier Biomedical Product Portfolio

## Solar Direct Drive Vaccine Refrigerator

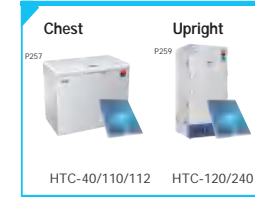

## Solar Direct Drive Freezer



## Solar Direct Drive Combined Refrigerator/Freezer



## Solar Direct Drive Blood Refrigerator



## RTMD

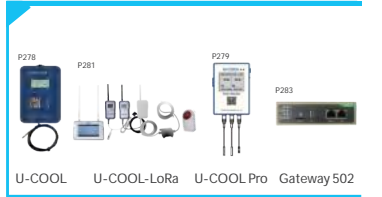

## Blood Bank Refrigerator



## Plasma Freezer



## Plasma Apheresis System



## Plasma Blast Freezer



## Platelet Incubator with Agitator



## Transport Cooler



## Transport Cooler



## Laminar Flow Cabinet



## Biological Safety Cabinet



## Hydrogen Peroxide Disinfectant



## Ductless Fume Hood



## Liquid Nitrogen Container



## CO2 Incubator



## Standard Incubator



## Drying Oven



## Cooled Incubator Climate Chamber



## Autoclave



## Centrifuge



## Consumables

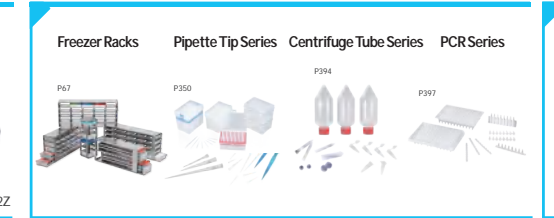

## Walk-in Cold Room

